



**WORLD
AQUATICS**

COMPETITION REGULATIONS

In force as from 5 July 2023

TABLE OF CONTENTS

| | |
|---|-----|
| PART ONE: RULES APPLICABLE TO ALL AQUATIC SPORTS..... | 3 |
| PART TWO: SWIMMING RULES | 114 |
| PART THREE: OPEN WATER SWIMMING | 174 |
| PART FOUR: DIVING RULES | 213 |
| PART FIVE: HIGH DIVING RULES | 293 |
| PART SIX: WATER POLO RULES..... | 340 |
| PART SEVEN: ARTISTIC SWIMMING RULES..... | 446 |
| PART EIGHT: MASTERS RULES | 543 |

PART ONE: RULES APPLICABLE TO ALL AQUATIC SPORTS

- 1. GENERAL RULES FOR OLYMPIC GAMES, WORLD CHAMPIONSHIPS AND WORLD AQUATICS COMPETITIONS**
- 1.1** World Aquatics alone shall have the right to organise World Championships and other World Aquatics competitions for Swimming, Diving, High Diving, Water Polo, Artistic Swimming, and Open Water Swimming. The words World and World Aquatics may not be used in connection with any Swimming, Diving, High Diving, Water Polo, Artistic Swimming, or Open Water Swimming event without the consent of World Aquatics.
- 1.2** The World Aquatics Bureau is competent to establish any rules and regulations pertaining to the conduct of the Olympic Games and World Aquatics Championships. It will notably establish the qualification period and system.
- 1.3** The Management Committee for the World Aquatics Championships shall be the members of the Bureau, who shall act as the Jury of Appeal.
- 1.4** For World Aquatics Championships and Olympic Games Technical Officials selections shall be determined by the appropriate Technical Committee, subject to approval by the Bureau or the Executive.
- 1.5** For each discipline in the Olympic Games and World Championships a Commission shall be appointed consisting of the respective Technical Delegate (Bureau Representative) and Chairman, Vice Chairman and Secretary of each respective Technical Committee.
- 1.6** Subject to the supervision of the World Aquatics Bureau, the Commissions shall be responsible for:
 - a) the conduct of the competition in the respective discipline;
 - b) the control of all technical equipment and installations prior to and during the event;
 - c) making rosters for officials; and
 - d) investigating cases of protest as preparation for the Jury of Appeal.

1.7 Political Action

No political action shall take place inside or in the immediate vicinity of event's venue(s). The promotion or announcement, by any means, of political messages or any other political actions inside or in the immediate vicinity of the venue(s) is strictly prohibited before, during and after the championships/competition.

1.8 Provocative Action, Racism

The Organisers of championships/competitions shall prevent any provocative action being taken by spectators inside or in the immediate vicinity of the event venue(s) (unacceptable levels of verbal provocation from spectators towards competitors or opposing fans, racist behaviour, provocative banners or flags etc.). Should such action arise, the Organisers of championships/competitions shall intervene over the public address system or remove any offensive material, if necessary, with assistance of the police. Stewards shall draw attention of the police to serious acts of misbehaviour, including racist insults; so that offenders may be removed from the venue should the police decide.

2. INTERNATIONAL COMPETITIONS AND WORLD AQUATICS CALENDAR

2.1 An International Competition shall refer to any competition organised or sanctioned by World Aquatics, any Continental or Regional Organisation or any Member in which other World Aquatics-recognised Federations, clubs or individuals participate.

2.2 International Competitions

2.2.1 International Competitions are divided into the following tiers:

Tier 1. Major Aquatics Competitions - the Olympic Games, World Aquatics Championships, World Aquatics Swimming Championships (25m);

Tier 2. Other World Aquatics Competitions - World Junior and Youth Championships in each discipline, World Cups, World Leagues, and other World Aquatics competitions;

Tier 3. Continental and Regional Competitions - Continental or Regional Multi-Sport Games, Competitions organised by Continental or Regional Organisations;

Tier 4. Member Federation International Competitions - Events organised or sanctioned by a Member Federation in which other World Aquatics Member Federations, clubs or individuals participate:

Tier 5. Other competitions of major international importance as defined by World Aquatics.

2.2.2 All Continental Organisations, Member Federations, and/or members of World Aquatics (including clubs), as well as independent organizers shall seek approval from World Aquatics before announcing dates and place for championships or events which they organize or sanction within their jurisdiction. Approval is, however, not necessary for national competitions in which foreign clubs or individuals not representing their Member Federation participate. The application for approval shall be submitted to World Aquatics at least six months prior to the proposed date of the championships or events.

2.2.3 Any approval of the International Competition from World Aquatics shall be subject to all conditions and requirements in accordance with the World Aquatics Rules, notably Article 26 of the Constitution. All athletes must comply with World Aquatics eligibility rules.

2.3 World Aquatic Calendar

2.3.1 World Aquatics shall compile and publish on its website the World Aquatics Calendar in which all International Competitions approved by World Aquatics shall be listed. When a new application for approval of an International Competition is received, World Aquatics will compare the proposed dates of the new International Competition with the World Aquatics calendar to determine if the new dates conflict with a previously approved International Competition. If a conflict is deemed to exist by World Aquatics (or any other issue arises in connection with the proposed International Competition) after considering the aquatic discipline, geographic region of the International Competition and/or age group of the Competitors and/or any other matter which World Aquatics may in its discretion take into consideration, World Aquatics will contact the new applicant and advise them that a conflict exists, and request that the dates be changed or competition is postponed to avoid the conflict. Applicants

are advised to check the World Aquatics Calendar for potential conflict in dates prior to applying for approval of a new International Competition. It is the policy of World Aquatics that no International Competition of major international importance, with the exception of Masters competitions, should be held within 30 days prior to any Tier 1 Event, without World Aquatics' prior consent.

2.3.2 Any cancellation or rescheduling of an International Competition that has been approved by World Aquatics and published on the World Aquatic Calendar shall be reported to World Aquatics as soon as practicable prior to the commencement of that competition.

2.4 Competition Programme

2.4.1 For Tier 3 Continental or Regional Multi-Discipline Competitions or Multi-Sport Games, the Competition Programme should include all aquatic disciplines where possible. Any Tier 3 International Competition should include at a minimum the Competition Programme for the relevant discipline at the prior Olympic Games. For Tier 4 and Tier 5 International Competitions, applicants are asked to state in the application for approval the competition programme to be adopted and any deviation from the Competition Programme for the relevant discipline at the prior Olympic Games.

2.4.2 Any application for approval of any International Competition shall indicate the modifications (if any) of the World Aquatics Rules and Regulations applicable to the event.

2.4.3 Failure to comply with this Section 2 may lead to possible sanctions in accordance with the World Aquatics Constitution.

3. SPORT NATIONALITY

3.1. Affiliation and Eligibility to represent a World Aquatics Member

3.1.1 An Athlete shall be eligible to compete at an International Competition representing a World Aquatics Member if he/she is affiliated to a sole World Aquatics Member and is a citizen of the Country that the Athlete represents by virtue of:

1. being a citizen of the Country by birth; or
2. being a citizen of the Country through naturalization and

having uninterrupted residence in the Country for at least three years prior to his/her first International Competition;

3.1.2 In the event an Athlete is a citizen of a country or Sport Country, but does not meet the requisites mentioned under I.3.1.1, he/she shall be eligible to compete at International Competitions for a World Aquatics Member by requesting World Aquatics' approval, which will be granted under the following conditions:

- a) the Athlete shall observe a waiting period of three years during which he/she shall not be entitled to represent a World Aquatics Member at International Competition(s);
- b) the Athlete shall be able to demonstrate by the end of the waiting period at the latest, that he/she has a genuine, close and established link to the country or Sport Country he/she will represent.

3.2. Election of a Sport Nationality

3.2.1 The Sport Nationality of an Athlete, if aged of more than sixteen years old or if aged of less than sixteen years old, but that no declaration is formulated as per I.3.2.2) under, is established at the occasion of the first International Competition that the Athlete is competing on behalf of a World Aquatics Member. If an Athlete is eligible to compete at International Competitions for more than one World Aquatics Member, he/she may choose which World Aquatics Member to represent, being specified that this choice is exercised by competing on behalf of the World Aquatics Member in an International Competition. Thereafter, an Athlete may only represent that World Aquatics Member in International Competitions.

3.2.2 An Athlete aged of less than sixteen years-old and who is eligible to compete at International Competitions for more than one World Aquatics Member has the possibility to declare to World Aquatics that his/her choice of sport nationality is under consideration. If he/she participates to an International Competition after having made his/her declaration to World Aquatics, his/her sport nationality will not be established by such participation.

3.2.3 In derogation of Rule I.3.2.2) above, a representation at the World Aquatics Championships or Olympic Games determines in all cases a Sport Nationality, no matter the age of the Athlete.

3.3. Change of Sport Nationality

3.3.1 Any Athlete that intends to change his/her Sport Nationality from one World Aquatics Member to another (“New World Aquatics Member”) shall request World Aquatics’ approval, which will be granted under the following requisites:

- the Athlete shall observe a waiting period of three years between the last representation for the Member and the first representation for the New World Aquatics Member. The Athlete shall not be entitled to represent any World Aquatics Member at International Competitions during this waiting period;
- the Athlete shall be a citizen by birth or naturalization of the country or Sport Country he/she will represent; and
- the Athlete shall have uninterrupted residence in the country or Sport Country of the New World Aquatics Member for at least three years prior to his/her first International Competitions or shall be able to demonstrate by the end of the waiting period at the latest, that he/she has a genuine, close and established link to the country or Sport Country he/she will represent.

3.3.2 If an Athlete intends to represent a New World Aquatics Member at any International Competitions, but has previously represented another Member at age categories only (i.e. U16, U18, U20, Youth or Junior), he/she must observe, in derogation of I.3.3.1 above, a waiting period of one year between the last representation at age category for the Member and the first representation for the New World Aquatics Member.

3.4. Bureau Consultation

In a case of eligibility or Sport Nationality possessing exceptional and unforeseen circumstances, the Executive Director may consult the Bureau on the application of these rules to an Athlete’s particular case. The Executive Director’s decision to not consult the Bureau is not appealable.

3.5 Possible Breach of the present Rules

3.5.1 Any possible breach of the present rules on eligibility and Sport Nationality may be referred to the Aquatics Integrity Unit for

investigation and possible proceedings according to the World Aquatics Constitution and Rules.

3.5.2 Without prejudice to any of its other sanctioning powers under the Integrity Code, the Aquatics Integrity Unit may disqualify an Athlete from the International Competitions in question, with all resulting consequences,

including forfeiture of all titles, awards, medals, points and prize and appearance money, if such Athlete represented a World Aquatics Member at any International Competitions in violation of the present rules on eligibility and Sport Nationality. In the event the Athlete competed as a member of a relay team or a team, the relay team or the team may similarly be disqualified with all resulting consequences, including forfeiture of all titles, awards, medals, points and prize and appearance money.

3.6 Enforcement

The present rules will come into force immediately on 21 February 2023 and will not have retroactive effect. They will apply to all eligibility and change of sport nationality matters filed with World Aquatics as from 21 February 2023. The World Aquatics Office may apply the previously enforced rules on sport nationality during a transitory period until 31 December 2023 at the latest, if the World Aquatics Member and/or Athlete demonstrates that the Athlete had initiated his/her process of eligibility or change of sport nationality before the entry into force of these new rules and that he/she relied upon the old rules on eligibility and sport nationality to organize his/her career. Such evidence may notably consist of correspondence related to an Athlete's change of sport nationality exchanged between the World Aquatics Member and World Aquatics before the entry into force of these new rules.

4. POLICY ON ELIGIBILITY FOR THE MEN'S AND WOMEN'S COMPETITION CATEGORIES

World Aquatics is committed to providing safe, fair, inclusive, and non-discriminatory opportunities for all Aquatics Athletes wishing to compete in World Aquatics Competitions. World Aquatics Bureau has thus adopted a Policy on Eligibility for the men's and women's competition categories and fully refers to it. Such Policy and its

annexes are a standalone regulation, being noted that some of its provisions are nonetheless included in the present Competitions Regulations regarding eligibility per category (Competitions Regulations I.5.2 to I.5.6).

5. ELIGIBILITY REQUIREMENTS FOR COMPETITION AND FOR SETTING WORLD AQUATICS RECORDS

5.1 Affiliation

Any Athlete shall be affiliated to a World Aquatics Member for being eligible to compete in World Aquatics Competitions and to set World Aquatics World Records in World Aquatics Competitions and other Aquatics events recognised by World Aquatics.

5.2 Eligibility per category

5.2.1 Subject to the requirements set forth below, all Athletes are eligible to compete in the men's category or in the women's category in World Aquatics Competitions and to set World Aquatics World Records in World Aquatics competitions and other events recognised by World Aquatics, whatever their legal gender, gender identity, or gender expression. No Athlete is excluded from a World Aquatics Competition or from setting World Aquatics World Records based on their legal gender, gender identity, or gender expression.

5.2.2 All issues relating to the eligibility of an Athlete under this Regulations to compete in a particular sex category will be determined by World Aquatics following consultation, as necessary, with one or more independent scientific and medical experts appointed by the World Aquatics Executive. It is an important part of this Regulations that the experts can assess whether a given Athlete meets the eligibility criteria set out below. To that end, World Aquatics may ask the Athlete to provide further information and documents and/or to submit to one or more medical examinations. All costs associated with this assessment will be borne by World Aquatics.

5.3 Certification

5.3.1 All Athletes must certify their chromosomal sex with their World Aquatics Member in order to be eligible for World Aquatics Competitions. Failure to do so, or provision of a false certification, will

render the Athlete ineligible.

5.3.2 World Aquatics Member must confirm their Athletes' certifications of chromosomal sex when registering their Athletes to compete in World Aquatics Competitions.

5.3.3 World Aquatics reserves the right to include a chromosomal sex screen in its anti-doping protocol to confirm such certification.

5.4 Eligibility for the Men's Category

5.4.1 All male athletes, including athletes with 46 XY DSD, are eligible to compete in World Aquatics competitions and to set World Aquatics World Records in the men's category, regardless of their legal gender, gender identity, or gender expression.

5.4.2 Female-to-male transgender athletes (transgender men) are eligible to compete in World Aquatics competitions and to set World Aquatics World Records in the men's category, except that:

5.4.2.1 For the disciplines of Water Polo and High Diving, the athlete must provide to World Aquatics an assumption of risk form (in the form set out in Appendix One to this Policy) signed and dated by the athlete or, if the athlete is a minor, by their legal proxy.

8 [Comment to Rule 1.5.4.2.1: It is strongly recommended that the athlete speaks with a qualified medical specialist prior to competition to ensure their physical ability to participate in the event in the men's category and to ensure that they understand the attendant risks.]

5.4.2.2 All athletes who are undergoing treatment involving testosterone or other anabolic substances as part of female-to-male gender-affirming hormone treatment are required to obtain a Therapeutic Use Exemption (TUE) for that treatment in accordance with the World Aquatics Doping Control Rules (DCR).

5.5 Eligibility for the Women's Category

5.5.1 All female athletes are eligible to compete in World Aquatics competitions and set World Aquatics World Records in the women's category, regardless of their legal gender, gender identity, or gender expression, under the following conditions:

5.5.1.1 Athletes who have previously used testosterone as

part of female-to-male gender-affirming hormone treatment (with or without a TUE) but are no longer following that treatment are eligible to compete in the women's category in World Aquatics competitions and to set World Aquatics World Records in the women's category in World Aquatics competitions and in other events recognised by World Aquatics if they can establish to World Aquatics's comfortable satisfaction that (a) the testosterone use was for less than a year in total (i.e., from the date of first use to the date of last use) and did not take place during pubertal growth and development, and (b) their testosterone levels in serum (or plasma) are back to pre-treatment normal and any associated anabolic effects have been eliminated.

5.5.1.2 Female athletes who have used testosterone in violation of the World Anti-Doping Code or World Aquatics DCR (or any other applicable anti-doping rules) may return to competition after they have served their period of ineligibility.

5.5.2 Male-to-female transgender athletes (transgender women) and athletes with 46 XY DSD whose legal gender and/or gender identity is female are eligible to compete in the women's category in World Aquatics competitions and to set World Aquatics World Records in the women's category in World Aquatics competitions and in other events recognised by World Aquatics if they can establish to World Aquatics's comfortable satisfaction that they have not experienced any part of male puberty beyond Tanner Stage 2 or before age 12, whichever is later. Specifically, the athlete must produce evidence establishing that:

5.5.2.1 They have complete androgen insensitivity and therefore could not experience male puberty; or

5.5.2.2 They are androgen sensitive but had male puberty suppressed beginning at Tanner Stage 2 or before age 12, whichever is later, and they have since continuously maintained their testosterone levels in serum (or plasma) below 2.5 nmol/L.

5.5.2.3 An unintentional deviation from the below 2.5 nmol/L requirement may result in retrospective disqualification of results and/or a prospective period of ineligibility.

5.5.2.4 An intentional deviation from the below 2.5 nmol/L requirement may result in retrospective disqualification of results and a prospective period of ineligibility equal or commensurate in length to periods imposed under the World Aquatics DCR for intentional anti-doping rule violations involving anabolic steroids.

9 [Comment to Rule 5.5.2.4: For purposes of the Policy, all measurements of serum testosterone must be conducted by means of liquid chromatography coupled with mass spectrometry.]

5.6 Process for Application

The process for applications for eligibility is set forth in the Operational Requirements (see Appendix Two to this Policy).

6. REGISTRATIONS AND SPORTS ENTRIES

6.1 General - Registration and Sport Entries

6.1.1 For World Aquatics Events

6.1.1.1 Each Federation concerned must confirm its desire to take part in the World Championships by completing the preliminary entries in the World Aquatics General Management System (GMS) by the defined “preliminary entries” deadline.

All entries must be fully submitted in the GMS before the date determined by World Aquatics as published in the respective summons for the Championships. World Aquatics shall verify all registrations according to appropriate eligibility rules for participation and competitor entry for each competition.

6.1.1.2 Each federation must confirm the final number of male and female competitors that will attend the Championships by completing their nomination in the World Aquatics General Management System (GMS) by the defined “nomination deadline”.

6.1.2 For Olympic Games

Sport entries shall be made on official forms signed by the Secretary of the respective National Olympic Committee and delivered to the Organising Committee of the Country holding the Games, on or

before the date determined by the International Olympic Committee. The World Aquatics Office shall claim these entries at least seven (7) days before the start of the first competition.

6.1.3 Substitution

Any entered competitor may be substituted by another entered competitor at the Team Leaders Meeting. It is mandatory for one representative of each Federation to take part in the Team Leaders Meeting. Failing to do so will result in a fine of one-hundred (100) Swiss Francs.

6.1.4 Withdrawal

In all competitions except water polo, a competitor or team not wishing to take part in a semi-final or final in which qualification was earned shall withdraw within thirty (30) minutes following the preliminaries or the semi-finals of the event in which the qualification took place. The member federation of any competitor who withdraws from the heats/preliminary rounds after the Team Leaders Meeting or from a semi-final or final more than thirty (30) minutes after the preliminaries or semi-finals of the event in which qualification was earned, shall pay without excuse to the World Aquatics the sum of one-hundred (100) Swiss francs; in case of a relay, duet, team or combination, the sum shall be two-hundred (200) Swiss francs.

If a team withdraws from a World Aquatics Water Polo event any time after the draw has been concluded, and without the approval of the Management Committee, then that team will be sanctioned by the Bureau with an economic sanction of 8,000 Swiss Francs, from which 6,000 Swiss Francs goes to the Organiser, and suspension from all competitions for a minimum period of three months up to a maximum period of two years.

6.1.5 Disqualification

In Swimming, Diving, and Artistic Swimming, where a competitor who competed in the semi-finals or final is disqualified for any reason, including medical control, the position he/she would have held shall be awarded to the competitor who finished next and all the lower placing competitors in the semi-finals or final shall be advanced one place. If the disqualification occurs after the presentation of awards, the awards shall be returned and given to the appropriate competitors applying the foregoing provisions.

6.1.6 Specific cases

6.1.6.1 Competitors entered for Diving, High Diving, Water Polo, and Artistic Swimming cannot swim relay events, and those entered for Swimming, Open Water Swimming, Diving, High Diving and Artistic Swimming cannot be used as Water Polo reserves, with the provision that one and the same swimmer could compete in Water Polo as well as other Swimming competitions, if officially entered for such competitions.

6.1.6.2 If an error by an official follows a fault by a competitor, the fault by the competitor may be expunged. If an official's call on deck leads to a review of an athlete's potential infraction, and it is deemed that the athlete made no error, the athlete will be cleared of the inquiry. Additionally, if an error by a competitor follows a fault by an official, the fault of the competitor shall be expunged.

6.2 Swimming - Registration and Sport Entries

6.2.1 Standard Entry Times A and B

For each individual event at the World Aquatics Championships, the World Aquatics Bureau will establish Standard Entry Times in two levels: "A" and "B", of which "B" shall be easier to achieve.

- Standard Entry Times can only be achieved in competitions approved for that purpose by World Aquatics.
- For each individual event at the World Aquatics Championships, each National Federation may enter a maximum of two (2) competitors. To enter two (2) swimmers in the same event, both of them must have achieved the "A" Standard Entry Time.

To enter one (1) swimmer in an event, the competitor must have achieved at least the "B" Standard Entry Time.

- Swimmers having achieved only one (1) "A" or one "B" entry time are entitled to enter one (1) additional event. The additional individual event
- must be in an event where no other swimmer from the National Federation has been entered.

6.2.1.1 Sport Entry with no Standard Times

At the World Aquatics Championships, National Federations may enter swimmers who have not achieved either Standard Entry Time as follows:

- With no swimmers who have achieved the “A” or “B” Standard Entry Time: National Federations may enter up to four (4) swimmers, two (2) men and two (2) women.
- With one (1) or two (2) swimmers who has achieved the “A” or “B” Standard Entry Time: National Federations may enter up to a maximum of four (4) swimmers (two (2) men and two (2) women), and with three (3) swimmers who have achieved the “A” or “B” Standard Entry Time, one (1) additional swimmer provided that both genders are represented.
- The swimmers who have not achieved a Standard Entry Time will only be permitted to enter up to two (2) individual events each.
- An individual entry for a swimmer without an “A” or “B” Standard Entry Time must be in an event where no other swimmer from the National Federation has been entered.

6.2.2 Entry of Relays

At the World Aquatics Championships, each National Federation may enter only one (1) team in each relay. The members of such entered team(s) shall comprise:

- Any swimmers entered in individual events even if they have not achieved a “A” or “B” Standard Entry Time for the corresponding stroke and distance of the relay in which they are entered;

Additional swimmers as relay-only competitors, provided that they have achieved the “B” Standard Entry Time for the corresponding stroke and distance of the relay in which they are entered. Any additional swimmers must be within the maximum quota of swimmers for the event.

The following formula shall apply:

- One (1) Relay: two (2) additional swimmers
- Two (2) Relays: four (4) additional swimmers

- Three (3) Relays: six (6) additional swimmers
- Four (4) Relays: eight (8) additional swimmers
- Five (5) Relays: ten (10) additional swimmers
- Six (6) or more Relays: twelve (12) additional swimmers

6.2.2.1 The names of swimmers actually swimming on a relay must be submitted at least one hour before the start of the session in which the event is to take place, in the order in which they are to swim. The names of swimmers in medley relay events must be listed for their respective strokes.

6.2.3 Swimming Qualifying Times

- World Aquatics will maintain a listing of Swimming Qualifying Times achieved during the qualification period, called the World Aquatics Rankings.
- National Federations will enter swimmers and relay teams using the World Aquatics Rankings as the entry time for seeding purposes. Where no valid time information is recorded in the World Aquatics Rankings, the swimmer or relay team will be entered with no time.
- Only valid times included in the World Aquatics Rankings at the date of the deadline for entries and achieved within the qualification period can be accepted as entry times.
- The National Federation must fully submit all sports entries via the World Aquatics GMS in accordance with the established entry deadlines in order to be accepted for the competition.
- The heats, semi-finals and finals shall be arranged in accordance with Rule III.3, under the supervision of the Technical Swimming Committee.

6.2.4 Maximum number of swimmers

Each Member may enter a maximum number of twenty-six (26) men and twenty-six (26) women swimmers.

6.2.5 Publication of Sport Entry List

The entry list shall be published at least four (4) days before the first day of competition.

6.2.6 Qualification system

The World Aquatics Bureau is competent to develop and define the Swimming qualification principles/system related to World Aquatics Championships and World Aquatics Swimming Championships (25m).

For the Olympic Games, it will be done in collaboration with the IOC.

6.3 Open Water Swimming - Registration and Sport Entries

6.3.1 Sports Entries for the Olympic Games and the World Aquatics Championships

Each Member Federation may enter a maximum of two (2) males and two (2) females per individual event.

For team events in the World Championships, the Member Federation can enter only one (1) team per event comprised of two male and two female Competitors. Athletes may only swim in one team event. Withdrawals can be made up to and including the Teams Technical Meeting, but no substitution is permitted.

6.3.2 Sport Entry for World Aquatics Junior Open Water Swimming Championships

Each Member Federation may enter a maximum of two (2) males and two (2) females per individual event.

For team events in the World Aquatics Junior Open Water Championships, the Member Federation can enter only one (1) team per event comprised of two male and two female Competitors. Athletes may only swim in one team event.

Teams events in 14-15-16; & U/19. Swimmers may only swim one team event.

6.3.3 Qualification system

The World Aquatics Bureau is competent to develop and define the qualification principles/system related to World Aquatics Championships.

For the Olympic Games, qualifying criteria will be determined in collaboration with the IOC.

6.4 Diving - Registration and Sport Entries

6.4.1 Sports Entry for the World Aquatics Championships

Each Member may enter a maximum of two (2) competitors, regardless of standards, for each individual event and one (1) team of two (2) competitors for each synchronised diving event.

6.4.2 Qualification system

The World Aquatics Bureau is competent to develop and define the Diving qualification principles/system related to World Aquatics Championships.

For the Olympic Games, it will be done in collaboration with the IOC.

6.5 Artistic Swimming - Registration and Sport Entries

6.5.1 Sports Entries for the Olympic Games and the World Aquatics Championships

For Olympic Games, Team routines shall consist of eight (8) athletes. The total number of athletes entered by each Federation (unless otherwise specified)

may not exceed nine (9) athletes one as reserve. The total number of athletes may include a maximum of two (2) male athletes.

For World Aquatics Championships and World Aquatics competitions, team routines shall consist of eight (8) competitors and ten (10) for Free Combination.

For Artistic Swimming World Aquatics competitions the total number of competitors entered by each Federation (unless otherwise specified) may not exceed fourteen (14) competitors including maximum two male competitors only if the Federation enters Mixed Duets/Teams.

6.5.2 Sports Entries World Aquatics Junior Artistic Swimming Championships

Each country shall be entitled to enter one Technical Solo, one Free Solo, one Technical Duet, one Free Duet, one Technical Mixed Duet, one Free Mixed Duet, one Technical Team, one Free Team, and one Acrobatic routine.

6.5.3 Qualification system

The World Aquatics Bureau is competent to develop and define the qualification principles/system related to World Aquatics Championships.

For the Olympic Games, it will be done in collaboration with the IOC.

6.6 Water Polo

6.6.1 Sports Entries For Water Polo, an entry of a maximum of thirteen (13) players per game may be accepted.

For the World Aquatics Championships thirteen (13) players and two (2) reserved players can be registered, but thirteen (13) players are in the actual playing squad. For the other World Aquatics Water Polo

Events, the number of registered players may vary, but there are maximum of thirteen (13) players on a game.

For the Olympic Games, an entry of a maximum of thirteen (13) players may be accepted.

6.6.2 Number of Teams for World Aquatics Championships

6.6.2.1 Men

6.6.2.1.1 The competition shall be between a maximum of sixteen (16) teams selected in the following manner:

6.6.2.1.2 The four (4) highest ranking teams from the preceding World Aquatics Championships, or Olympic Games, two (2) highest ranking teams from the preceding year's World Cup (formerly World League), one (1) team from the host country and nine (9) teams from the five (5) continents to be selected through continental qualification tournaments or continental championships. The nine (9) teams from the continents shall be selected according to the following formula: Europe - 3; Americas - 2; Asia - 2; Africa - 1; and Oceania - 1.

6.6.2.1.3 If any one of the teams qualified from the preceding year's World Cup (formerly World League) are in the first four (4) from the preceding World Aquatics Championships or Olympic Games, the next ranked team from that World Aquatics Championships or Olympic Games qualifies.

6.6.2.1.4 The highest qualifying team(s) from the continental qualification tournament or continental championships shall be entitled to represent that continent; if any team does not accept, then the next highest ranking team willing to accept and participate in the World Aquatics Championships shall qualify.

6.6.2.1.5 If the host country is already included in the four (4) highest ranking teams from the preceding World Aquatics Championships, World Cup or Olympic Games, then that entry position shall be filled by the next highest placed team from that World Aquatics Championships Olympic Games.

6.6.2.1.6 If another of the four (4) highest ranking teams from the preceding World Aquatics Championships or Olympic Games or one (1) of the two (2) highest ranking teams from the preceding year's World Cup does not enter, then that position shall be filled from the next highest placed team from that World Aquatics Championships or Olympic Games.

6.6.2.1.7 If no team enters from a continent or if there is an unfilled vacancy from among the teams qualifying from the preceding World Aquatics Championships, Olympic Games or preceding year's World Cup, then each vacancy for that World Championship shall be filled by the next highest placed team(s) from the continental qualification tournament or continental championships with the following rotation: Asia, Americas, Europe, Oceania and Africa.

6.6.2.2 Women

6.6.2.2.1 The competition shall be between a maximum of sixteen (16) teams selected in the following manner:

6.6.2.2.2 The four (4) highest ranking teams from the preceding World Aquatics Championships or Olympic Games, two (2) highest ranking teams from the preceding year's World Cup (formerly World League), one (1) team from the host country and nine (9) teams from the five (5) continents to be selected through continental qualification tournaments or continental championships. The nine (9) teams from the continents shall be selected according to the following formula: Europe - 3; Americas - 2; Asia - 2; Africa - 1; and Oceania - 1.

6.6.2.2.3 If any one of the teams qualified from the preceding year's World Cup are in the first four (4) from the preceding World Aquatics Championships, World Cup or Olympic Games, the next ranked team from that World Championships/Olympic Games qualifies.

6.6.2.2.4 The highest qualifying team(s) from the continental qualification tournament or continental

championships shall be entitled to represent that continent; if any team does not accept, then the next highest ranking team willing to accept and participate in the World Championships shall qualify.

6.6.2.2.5 If the host country is already included in the four (4) highest ranking teams from the preceding World Aquatics Championships, World Cup or Olympic Games, then that entry position shall be filled by the next highest placed team from that World Aquatics Championships or Olympic Games.

6.6.2.2.6 If another of the four (4) highest ranking teams from the preceding World Aquatics Championships or Olympic Games or one (1) of the two (2) highest ranking teams from the preceding year's World Cup does not enter, then that position shall be filled from the next highest placed team from that World Championships or Olympic Games.

6.6.2.2.7 If no team enters from a continent or if there is an unfilled vacancy from among the teams qualifying from the preceding World Aquatics Championships or Olympic Games or preceding year's World Cup, then each vacancy for that World Championship shall be filled by the next highest placed team(s) from the continental qualification tournament or continental championship with the following rotation: Asia, Americas, Europe, Oceania and Africa.

6.6.3 Number of Teams for Olympic Games

6.6.3.1 Men

The competition shall be between twelve (12) teams

6.6.3.2 Women

The competition shall be for ten (10) teams.

6.6.3.3 Qualification system

In collaboration with IOC, the World Aquatics Bureau is competent to develop and define the qualification principles/system related to the Olympic Games.

6.6.4 Number of Teams for World Aquatics Water Polo Championships U20

6.6.4.1 Men

6.6.4.1.1 The competition may be between twenty (20) teams.

6.6.4.1.2 For the twenty (20) team competition, the competition may occur at two (2) sites in one country. The host country will be responsible for the transportation of the teams from one site to another as required. This transportation will be at the expense of the host country.

6.6.4.1.3 In the case of a maximum twenty (20) team competition, the teams shall include the highest-ranking team from the preceding U20 World Aquatics Championships with the remaining teams selected through continental qualification tournaments or continental qualification tournaments or continental championships according to the following formula: Europe - 7; Americas - 5; Asia - 4; Africa - 2; and Oceania - 2. The host to be included in the Continental quota. The highest ranking team from the preceding U20 World Aquatics Championships will be considered to be a representative of that continent for the purpose of the formula.

6.6.4.1.4 The highest qualifying team(s) from the continental qualification tournament or continental championships shall be entitled to represent that continent; if any team does not accept, then the next highest-ranking team willing to accept and participate in the World Junior Championships shall qualify.

6.6.4.2 Women

6.6.4.2.1 The competition may be between twenty (20) teams.

6.6.4.2.2 For the twenty (20) team competition, the competition may occur at two (2) sites in one country. The host country will be responsible for the transportation of the teams from one site to another as required. This transportation will be at the expense of the host country.

6.6.4.2.3 In the case of a maximum twenty (20) team

competition, the teams shall include the highest-ranking team from the preceding U20 World Aquatics Championships with the remaining teams selected through continental qualification tournaments or continental qualification tournaments or continental championships according to the following formula: Europe - 7; Americas - 5; Asia - 4; Africa - 2; and Oceania - 2. The host to be included in the Continental quota. The highest-ranking team from the preceding U20 World Aquatics Championships will be considered to be a representative of that continent for the purpose of the formula.

6.6.4.2.4 The highest qualifying team(s) from the continental qualification tournament or continental championships shall be entitled to represent that continent; if any team does not accept, then the next highest-ranking team willing to accept and participate in the World Junior Championships shall qualify.

6.6.4.2.5 For a maximum of twenty (20) team competition, if there is an unfilled vacancy from a continent, then that vacancy shall be filled by the next highest placed team(s) from the continental qualification tournament or continental championship with the following rotation: Asia, Americas, Europe, Oceania and Africa.

6.6.5 Number of Teams for World Aquatics Water Polo Championships U18

6.6.5.1 Men

6.6.5.1.1 The competition may be between twenty (20) teams.

6.6.5.1.2 For a twenty (20) team competition, the competition may occur at two (2) sites in one country. The host country will be responsible for the transportation of the teams from one site to another as required. This transportation will be at the expense of the host country.

6.6.5.1.3 In the case of twenty (20) team competition, the teams shall include the highest-ranking team from the preceding World Youth Championships with the remaining

teams selected through continental qualification tournaments or continental championships according to the following formula: Host – 1; Europe – 7; Americas – 5; Asia – 3; Africa 2; and Oceania – 2. The highest-ranking team from the preceding World Youth 3 Championships will be considered to be a representative of that continent for the purpose of the formula.

6.6.5.1.4 The highest qualifying team(s) from the continental qualification tournament or continental championships shall be entitled to represent that continent; if any team does not accept, then the next highest ranking team willing to accept and participate in the World Youth Championships shall qualify.

6.6.5.1.5 For a maximum twenty (20) team competition, if there is an unfilled vacancy from a continent, then that vacancy shall be filled by the next highest-placed team(s) from the continental qualification tournament or continental championship with the following rotation: Asia, Americas, Europe, Oceania and Africa.

6.6.5.2 Women

6.6.5.2.1 The competition may be between twenty (20) teams.

6.6.5.2.2 In the case of a maximum twenty (20) team competition, the teams shall include the highest-ranking team from the preceding U20 World Aquatics Championships with the remaining teams selected through continental qualification tournaments or continental qualification tournaments or continental championships according to the following formula: Europe - 7; Americas - 5; Asia - 4; Africa - 2; and Oceania - 2. The host to be included in the Continental quota. The highest-ranking team from the preceding U20 World Aquatics Championships will be considered to be a representative of that continent for the purpose of the formula.

6.6.5.2.3 highest-ranking qualifying team(s) from the continental qualification tournament or continental

championships shall be entitled to represent that continent; if any team does not accept, then the next highest ranking team from the continental qualification tournament or continental championships shall be entitled to represent that continent.

6.6.5.2.4 If there is an unfilled vacancy from a continent, then that vacancy shall be filled by the next highest placed team(s) from the continental qualification tournament or continental championships with the following rotation: Asia, Americas, Europe, Oceania and Africa.

6.6.6 Number of Teams for World Aquatics Water Polo Championships U16

The competition may be between a maximum of thirty two (32) men teams and a maximum of twenty four (24) women teams. The list of teams is upon Continental invitations. The teams shall include the highest ranking team from the preceding World U16 Championships with remaining teams selected through continental qualification tournaments or continental championships and finally on Continental recommendation.

6.6.7 Olympic Games Qualification Tournament - Men

The competition shall be between a maximum of twelve (12) teams selected through continental qualification tournaments or continental championships in the following manner:

The twelve (12) teams from the continents shall be selected according to the following formula: Europe - 5; Americas - 3; Asia - 2; Africa - 1; and Oceania - 1. The Host Country will be considered to be a representative from that Continent.

The highest qualifying team(s) from the continental qualification tournament or continental championship (except the team who has already qualified) shall be entitled to represent that continent; if any teams do not accept, then the next highest ranking team willing to accept and participate in the Olympic Games Qualification Tournament shall qualify.

If there is an unfilled vacancy from a continent, then that vacancy shall be filled by the next highest placed team(s) from the continental qualification tournament or continental championship with the

following rotation: host continent of the Olympic Games Qualification Tournament, Americas, Asia, Europe, Oceania and Africa.

6.6.8 Qualification for Olympic Games - Women

The competition shall be for a maximum of ten (10) teams selected in the following manner:

The first team from the preceding year's World Cup.

The first team from the preceding World Championships. If this team has already qualified from the preceding year's World Cup, the next ranked team from the World Championships qualifies.

The Host Country will automatically qualify.

Automatically, one (1) team from the Continental Championships of the five (5) continents. If it is qualified at the preceding year's World Cup, or at the preceding FINA World Championships, then the next ranked team from the continental championships will qualify.

The other two (2) teams qualify from the Olympic Games Qualification Tournament - Women.

If for any reason, qualified teams do not wish to participate in the Olympic Games, the next ranking team(s) will then be taken in order from their placing at the Olympic Games Qualification Tournament – Women.

AQUA has authority to amend the rule and list in chronological order to reflect the qualification of teams in accordance with the timing of AQUA Events.

7. SWIMWEAR AND WEARABLES

7.1 Swimwear for all Aquatics Disciplines

Swimwear to be used in World Aquatics Competitions, World Aquatics Sanctioned Competitions, qualifying events for World Aquatics Competitions or Olympic Games shall meet the requirements provided in this section. The Rules in this Section are also complemented by Swimwear Rules per Aquatics Disciplines (Sections III to IX under) and Technical & Approval Implementing Rules for Swimwear (I.7.5).

The Athlete' safety and health are to be taken into consideration and all matters regarding Swimwear shall be treated with due regard to

fair play and a sound development of the Disciplines.

Athletes' Swimwear shall be in good moral taste and suitable for the individual Aquatics disciplines and not to carry any symbol which may be considered offensive.

These rules do not regulate directly issues on markings (team, emblems, manufacturer markings, sponsor markings), which are described under Section 1.8. However, they address markings (including also technical markings) in connection with their potential relevance from the point of view of the approval criteria (notably thickness and permeability).

7.2 Swimwear Approval Procedure for Swimming and Open Water

7.2.1 Swimwear to be used in World Aquatics Competitions, World Aquatics Sanctioned Competitions, qualifying events for World Aquatics Competitions or Olympic Games in Swimming and Open Water shall be approved by World Aquatics.

7.2.2 The Technical & Approval Implementing Rules for Swimwear (I.7.5) define the requirements linked to design, composition, colour, material, flexibility, construction and others related to Swimsuit, Wetsuit, Caps and Goggles.

7.2.3 The Approval Procedure of Swimwear is conducted by the World Aquatics Office and supervised by an independent swimwear expert.

7.2.4 The Independent Swimwear Expert – Appointment

The Independent Swimwear Expert is appointed and removed by the World Aquatics Bureau. He/she shall be independent from the manufacturers. In particular, he/she shall not have any relationship with a Swimwear manufacturer (whether of contractual nature or as a shareholder direct or indirect) nor have had such during the five (5) preceding years.

7.2.5 The Independent Swimwear Expert – Role

The Independent Swimwear Expert shall develop and propose uniform principles and directions for the approval of new advancements in the field of competition equipment.

The Independent Swimwear Expert will have the following

responsibilities and authority:

- to check if the swimwear complies with the technical requirements of these Regulations, and the Technical & Approval Implementing Rules for Swimwear, in cooperation with the testing laboratory;
- to approve or reject the application submitted by the manufacturers;
- to provide expertise to the World Aquatics Office; and
- any other matter related to Swimwear.

7.2.6 Implementing rules regarding the Approval Procedure, notably as such as the submission, the examination of a submission, the notification of the results of a submission, or re-submission, are defined under the Technical & Approval Implementing Rules for Swimwear.

7.2.7 To be approved, the Swimwear shall be available on the market (available for purchase by World Aquatics Members and Athletes) at the latest by 1st January following the publication of the List of Approved Swimwear as per Competitions Rules I.7.4 and I.7.5.

7.3 Testing

Testing standards applicable to the examination, in particular thickness and permeability measurements, are determined under the Technical & Approval Implementing Rules for Swimwear (I.7.5).

7.4 List of Approved Swimwear

World Aquatics will annually publish by 1st September at the latest a List of Approved Swimwear that may be used by Athletes at World Aquatics Competitions, World Aquatics Sanctioned Competitions, qualifying events for World Aquatics Competitions or Olympic Games in Swimming and Open Water. The List of Approved Swimwear will include the Swimwear approved the previous years (subject to a change in the implementing rules regarding the Approval Procedure) and the Swimwear approved during the last Approval Procedure.

In order to present an accurately updated publication of the List of Approved Swimwear, Applicants shall notify to World Aquatics, by 15th July of each year at the latest, about (i) formerly approved Swimwear which are to be discontinued by the next 1st January, and (ii) newly approved Swimwear which will not be available by the next 1st

January. The discontinued and non-available Products will be removed or will not be included in the List of Approved Swimwear for the subsequent year.

7.5 Technical and Approval Implementing Rules for Swimwear

Before any swimwear with a new design, Construction or Material is used in competition, the manufacturer of such swimwear must submit the swimwear to World Aquatics and obtain approval of World Aquatics.

The Swimwear and/or Material used must not put the health of the athletes at risk.

7.5.1 Swimsuits

This section is related to Swimsuits used in Swimming and in Open Water Swimming Disciplines with a water temperature greater than 18°C.

7.5.1.1 Design

7.5.1.1.1 Decency

The wearing of the swimsuit shall not offend morality and good taste (in particular, but not exclusively, because of the cut of the suit and body parts exposure whether covered or not).

7.5.1.1.2 Shape (Surface covered)

For swimsuits used in pool swimming competitions:

Women's swimsuits shall not cover the neck or extend past the shoulders, or below the knee.

Men's swimsuits shall not extend above the navel or below the knee.

For swimsuits used in open water swimming competitions:

Men's and Women's swimsuits shall not cover the neck, extend past the shoulder, or extend below the ankle.

Swimsuits fulfilling shape requirements for pool competitions comply a fortiori with shape requirements for Open Water swimming competitions.

Please contact the AQUA Office with any cultural or religious concerns with the application of this rule.

7.5.1.2 Structure / Composition / Other items

Men's swimsuits are in one (1) piece.

Subject to observance of the decency rule and limitations of the body surface covered, women's swimsuits may be in one (1) or two (2) pieces.

Other items covering the body that are not part of the swimsuit are prohibited.

7.5.1.3 Colours

To avoid any doubt, colours will not be considered as part of the design. Colours can vary freely.

However, colour variations shall not affect compliance with any requirements and tested values.

7.5.1.4 Material (general)

7.5.1.4.1 Type of Material

The Material used for swimsuits can be only "*textile Fabric(s)*".

For the purpose of these rules, this is defined as Material consisting of, natural and/or synthetic, individual and non-consolidated yarns used to constitute a fabric by weaving, knitting, and/or braiding.

7.5.1.4.1.1 Non-textile Material/elements/applications

Non-textile Material/elements/applications can be used on seams in the following cases:

- In "edge seams" including in particular "grippers", to ensure holding functions, e.g. through silicone strips and/or elastic cord(s).
- In waistbands and straps (e.g. elastic cord inside folded Material)
- Use of glue to fix the seam or the corresponding reinforcement tapes on (e.g. to hold welded seams or to cover seams in merging areas)

7.5.1.4.2 Surface treatment of the textile fabric

Any Material added on to the surface of the textile fabric (any

part thereof) or processing of the same (e.g. coating, printing, impregnation, heating, calendaring etc.) shall not close the overall open mesh structure of the base textile fabric.

The treated Material shall further comply with all requirements specified in these rules and particularly in regard to thickness, permeability and flexibility which must be and remain compliant, both at production stage until finished product stage and when the swimsuits are in actual use.

The rules regarding surface treatment do not apply to seams (sawn, welded, taped, glued, etc.), markings (manufacturer and/or sponsor logos as permitted by the applicable competition rules: printed or affixed on the base Material) or labels (homologation or technical labels as permitted by the rules).

7.5.1.4.3 Flexibility

The Material shall be flexible and soft folding.

7.5.1.4.4 Regular flat Material

The Material shall be regular and flat.

The Material shall not form outstanding shapes or structures, such as scales.

A thickness variation of the Material is permitted provided the thinnest point should not be less than 50% of the thickest point.

The overall thickness limitation (0.8 mm) shall in any event be respected at the thickest point(s).

7.5.1.4.5 Variation of Material colours

Variation of colours (or country-colours design) of the same Material is possible as long as the colouring does not affect compliance with tested value limits. Manufacturers are fully responsible to ensure that requirements in respect of all tested values (permeability, thickness, etc.) are respected in any colour variation.

Accordingly, the applicants may, but are not obliged, to submit Material samples for all colours variations they may intend to use

for a particular model. However, the Material samples provided must be consistent with the submitted swimsuit sample.

This implies:

- The Materials samples provided must be provided in the same colour as used in the corresponding submitted swimsuit sample;
- If a submitted swimsuit sample is made of patches of the same Material in different colours, then corresponding Material samples shall be provided for each of the colours actually used in the submitted swimsuit sample.

7.5.1.4.6 Outside treatment

No outside treatment shall be added on the Material.

7.5.1.4.7 Variety of Materials

Different materials may be used in one swimsuit provided that all materials are textile fabrics as defined above and that the swimsuit complies with all other criteria.

7.5.1.4.8 Combination/inside layer

A combination of maximum two (2) layers of Materials is permitted.

The combination of layers shall not create outstanding shape(s) or structure(s). An inside layer of Material can be used notably for comfort, protection of sensitive parts or decency.

Permeability and thickness of layered Materials shall be measured on both layers as combined together and the combination of layers must thus comply with thickness and permeability requirements as set forth in these rules in all parts of the swimsuit.

For the testing, applicants must provide unbound sample of each Material. The fabric samples submitted for approval shall be cut in the principle direction of the yarns/fabric (in the direction of the roll of Material).

7.5.1.5 Measurements of the Material

7.5.1.5.1 Thickness

The total thickness of Material(s) used shall have a maximum

value of 0.8 mm.

The thickness of layered Materials is the total thickness of both layers measured together.

It is clarified that this maximum thickness does not apply to seams as far as the seams are functional, and their thickness and width are the result of their natural functions.

The measurement procedure for thickness is described in the Testing Section (I.7.5.6.1).

7.5.1.5.2 Permeability

Material(s) used must have at any point (except on seams, logos or labels) a permeability value of more than 80 liters/m²/second.

Permeability values are measured on Material with a standard multidirectional stretch of 25%.

However, measures on Material which cannot be significantly stretched will be carried out on unstretched, flattened Material.

Permeability of layered Materials is the permeability of both layers measured together.

The measurement procedure for permeability is described in the Testing Section (I.7.5.6.2).

Permeability will not be tested on seams, provided they are considered as legitimate and functional seams. Seams must remain limited to functional purposes. The use of seams shall not affect compliance with requirements. However, the seams themselves are exempted from the application of the thickness rule and the permeability is not measured on seams.

7.5.1.6 Construction

No zippers or other fastening system is allowed.

Seams shall be limited to functional systems and shall not create outside shapes.

Use of seams (notably number, overall length, and disposition) shall not affect compliance with the requirements set forth herein.

External stimulation or influence: swimsuits which include any system providing external stimulation or has an influence of any type

(including pain reduction, chemical/medical substance release, electro stimulation etc.) are prohibited.

7.5.1.6.1 Seams

Swimsuits include various elements which have a joining, binding and/or finishing function (seams).

These seams include:

- Seams in the narrow meaning of the word (i.e. the element binding different parts of continuous Material),
- Edge Seams at the edges of the swimsuits,
- Grippers, i.e. edge seams which hold the legs of the swimsuits in place and,
- Waistbands holding jammers or briefs.
- Further Straps may be used to hold the upper part of women bodysuits.

All these elements have a specific construction (i.e. sewn or welded seams, use of folded Material, use of elastic bands or silicone or similar strips) which is different from the sole use of textile Material.

In each case, the functionality of the seams will be evaluated according to the above definition including grippers, waistbands and straps. Without prejudice to decisions in specific cases regarding these elements, the following principles will be taken into consideration.

7.5.1.6.1.1 General principles

The below is provided for guidance only and without prejudice. The decision will be based on an overall evaluation of the individual swimsuits. The purposes of the seams are:

- To join together the elements of the swimsuit = seams
- To finish properly the swimsuit at its edges = edge seams
- To prevent the swimsuit legs to roll back = grippers
- To hold a jammer or brief = waistband
- To maintain the upper part of a women's bodysuit = straps

The seams must be fit for the above purposes and shall have no other function.

The elements described in I.7.5.1.6.1.2 and I.7.5.1.6.1.3 will be considered in this respect:

7.5.1.6.1.2 Width

- Joining seams shall not exceed **5 mm**.
- Reinforcement/protection tapes such as those used to form or cover welded seams shall not exceed **20 mm**.
- Edge seams and grippers shall not exceed **20 mm**.
- Waistbands shall not exceed **25.4 mm (= one inch)**.
- Straps, or combination of straps, shall not exceed **50 mm**.

In case of seams based on a technique using glue and a covering tape (notably to take into account overspill or irregularities in the treatment), the glued area is part of the seam (bounding area) and must remain within the maximum width.

7.5.1.6.1.3 Number of seams

Excessive number of seams is prohibited.

Development in regard of seams will be carefully observed. The Independent Swimwear Expert reserves the possibility to intervene against excessive or non-functional seams.

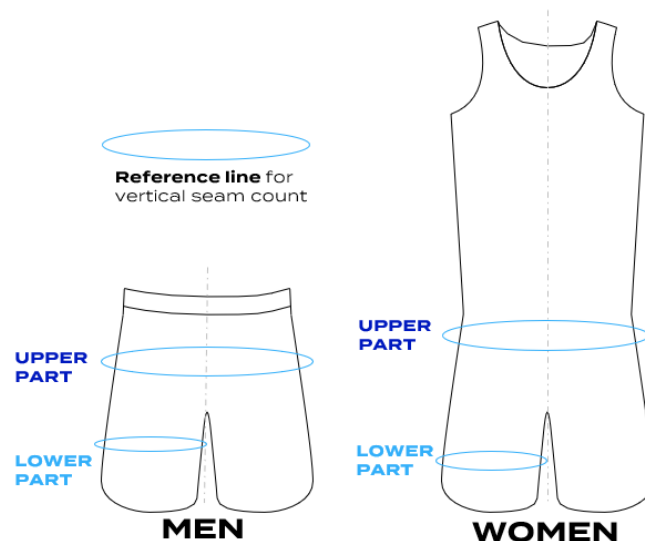

The authorised number of seams are:

For the upper part (above the crotch area):

- ▶ 9 seams for Men swimsuits,
- ▶ 11 seams for Women swimsuits.

For the lower part (below the crotch area):

- ▶ 4 on each leg for both Men and Women suits.

When two (2) or more seams are combined or merged, they count as two or more different seams in any area where their combined width is above the maximum width of a seam.

The reference line is always horizontal.

The total number of seams is the sum of the full circumference.

7.5.2 Wetsuits

This section is related to wetsuit used in Open Water Swimming competitions with water temperature below 18°C.

7.5.2.1 Design

Wetsuits shall completely cover torso, back, shoulders and knees. They shall not extend beyond the neck, wrists and ankles.

The body parts, after the elbow and/or below the knee, does not necessarily to be covered.

7.5.2.2 Composition

Wetsuits for both men and women shall be in one (1) piece.

7.5.2.3 Type of Material

Material used for wetsuits must have thermal insulation properties (for example foam of polychloroprene (Neoprene) or of polyurethane or other Material with similar insulating properties).

Note: The thermal insulation properties are not controlled nor tested in the approval procedure. The approval does not constitute any warranty or confirmation by World Aquatics and/or the Independent Swimwear Expert, of the capacity of the approved wetsuits models, when used, to effectively protect the swimmers from low temperature.

The Material can be multilayered, with non-water permeable layers.

The Material cannot contain injected gas.

Material without insulating properties cannot be used.

7.5.2.4 Measurement of Material

7.5.2.4.1 Thickness

The thickness of Materials used shall be minimum 3 mm and maximum 5 mm.

Provided the insulating functions are not prejudiced, the Applicant may apply for lowering of the minimum thickness value in limited specific areas, if such is functionally justified to allow free swimmer's movements. A decision in this respect is made at the Independent Swimwear Expert' s discretion and cannot be challenged.

7.5.2.4.2 Permeability

Permeability is not measured.

7.5.2.5 Construction

Zippers or other fastening systems are allowed without specific limitations.

They must be functional.

7.5.2.6 Guidelines for coverage and measures

Vast majority of wetsuits are failing because of thickness of Materials (not the design).

Maximum/minimum values for approval remain unchanged:

- 5.0 mm Max thickness OK
- 3.0 mm Min thickness OK
- 1.2 mm Min thickness OK

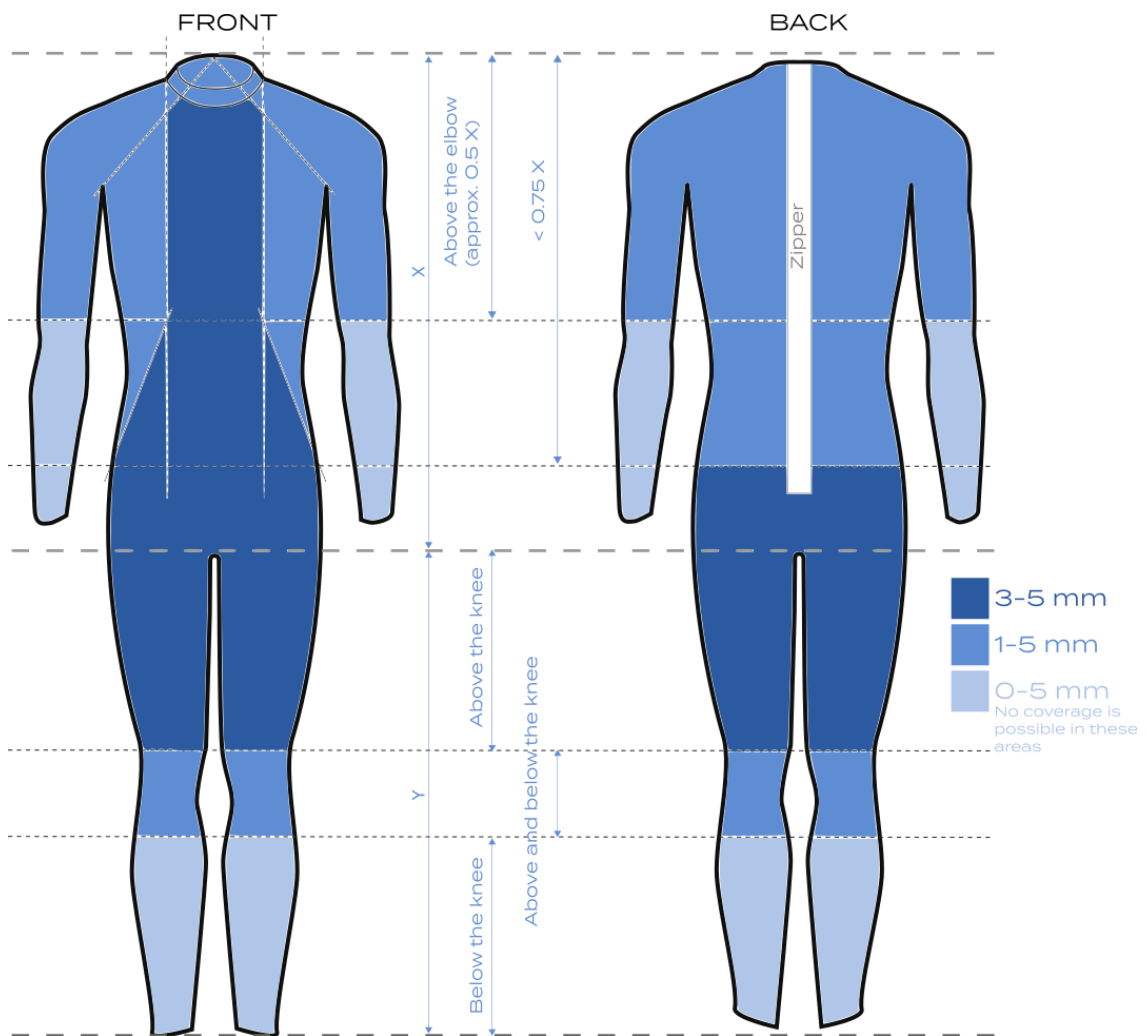

The table below gives a guideline to the manufacturers with regards to Material (total thickness) ensuring that the final thickness on finished garments is compliant:

| Chosen Nominal Material Thickness (mm) | Fabrication tolerances (+/- %) | Upper / Lower bound (mm) | Measurements tolerances (+/- mm) | Upper-Upper / Lower-Lower bound (mm) | Rounded limit values (mm) | Reached limits | |
|--|--------------------------------|--------------------------|----------------------------------|--------------------------------------|---------------------------|----------------|-------------------|
| | 10 | | 0.20 | | | | |
| For max. 5.00 mm | | | | | | | |
| | | Upper Bound | 4.40 | Upper/Upper bound | 4.60 | 5.00 | Max. thickness OK |
| | | | | Upper/Lower bound | | | |
| 4.00 | | | | | | | |
| | | Lower bound | 3.60 | Lower/Upper bound | 3.80 | | |
| | | | | Lower/Lower bound | 3.40 | | |
| For min 3.00 mm | | | | | | | |
| | | Upper Bound | 3.85 | Upper/Upper bound | 4.05 | | |
| | | | | Upper/Lower bound | 3.65 | | |
| 3.50 | | | | | | | |
| | | Lower bound | 3.15 | Lower/Upper bound | 3.35 | | |
| | | | | Lower/Lower bound | 2.95 | | |
| | | | | | | 3.00 | Min. thickness OK |
| For min 1.00 mm | | | | | | | |
| | | Upper Bound | 1.65 | Upper/Upper bound | 1.85 | | |
| | | | | Upper/Lower bound | 1.45 | | |
| 1.50 | | | | | | | |
| | | Lower bound | 1.35 | Lower/Upper bound | 1.55 | | |
| | | | | Lower/Lower bound | 1.15 | | |
| | | | | | | 1.20 | Min. thickness OK |

7.5.3 Caps

This section is related to swimming cap used in Swimming and in Open Water Swimming Disciplines.

7.5.3.1 Design

The cap is an Independent item.

The cap shall not be attached to the swimsuit, wetsuit or goggles nor be in continuity therewith (i.e.no "hood" or "mask" effect).

7.5.3.1.1 Shape

The shape shall follow the natural form of the head.

7.5.3.1.2 Surface

The outer surface shall not include outside artificial shaping such as rigs or spoilers and similar.

7.5.3.2 Material

7.5.3.2.1 Hardness

No hard Material (Material can have some rigidity but shall be able to follow the shape of the head: no hard helmets).

7.5.3.2.2 Type of Material

Different types of Materials may be used on the same cap.

The Materials can be of different thicknesses, subject to respect of the maximum thickness (see below). However, differences in the thickness shall not be used to form shapes in the outer surface.

Thickness: The maximum thickness in all points shall be lower or equal to 2 mm.

7.5.3.3 Construction

Seams, if any, shall be functional and shall not create outside shapes.

7.5.3.4 Colours

To avoid any doubt, colours will not be considered as part of the design. Colours can vary freely. However, colour variations of the cap shall not affect compliance with the above requirements.

7.5.4 Goggles

7.5.4.1 Design

The goggles are an independent item.

The goggles shall not be attached to the cap nor be in continuity therewith (no "*mask*" effect).

7.5.4.2 Material/construction

7.5.4.2.1 Safety standards and functionality

The goggles shall comply with prevailing safety standards for eyewear. Goggles have the function to protect the eyes against water and ensure visibility. Their design or construction shall serve these functions and especially shall not seek to obtain aquadynamic advantages (e.g. through extended shapes not related to the above functions).

7.5.4.3 Colours

To avoid any doubt, colours will not be considered as part of the design. Colours can vary freely. However, colour variations of the goggles shall not affect compliance with the above requirements.

7.5.5 Approval Procedure

7.5.5.1 Submission

7.5.5.1.1 The Applicant

The Applicant shall be the company which actually markets the corresponding Swimwear to its end-users through customary sales channels (wholesalers/retailers/direct sales), respectively sells and/or supplies the same to competitors and teams.

Manufacturers acting as subcontractors for one or more other companies cannot apply for approval of the swimwear supplied to other companies.

If a specific model is manufactured and supplied to different companies which then market or supply it, an approval shall be requested by each of these different companies, irrespective of the fact that the models marketed or supplied by these companies may have the same manufacturing sources.

If the same company or companies belonging to a unique group of companies, market or supply the same swimwear product under different trademarks, a single application can be submitted on behalf of the company and/or on behalf of the group.

7.5.5.1.2 Products to be submitted

Please refer to the Rules I.7.1 and I.7.2.

7.5.5.1.3 Application

The Application Protocol is described on World Aquatics' website.

7.5.5.1.4 Submission Dates

The submission dates (submission deadline) applicable at the time of the entry into force of the present regulations are:

- 1st of February
- 1st of May and
- 15th of September

Explanatory Note

- Swimwear approved during the submission of 1st of February will be included in the Approved List published on the 1st September of the same year
- (1st February 2023 → 1st September 2023)
- Swimwear approved during the submission of 1st of May will be included in the Approved List published on the 1st September of the same year
- (1st May 2023 → 1st September 2023)
- Swimwear approved during the submission of 15th September will be included in the Approved List published on the 1st September of the following year
- (15th September 2023 → 1st September 2024)

Applications received at the World Aquatics office after the Submission Date will not be considered. However, World Aquatics has the discretion (but no obligation whatsoever) to grant the Applicant a short deadline to complete its application.

7.5.5.1.5 Contribution to Administrative and Expert / Testing Costs

A contribution to the administrative and expert/testing costs will be charged to the Applicants for each application, including resubmission.

The applicable contribution will be based on the number of Products and Materials submitted with each application and will include the fees:

- for each Swimwear submitted (swimsuit, wetsuit, goggles, caps);
- for each Material submitted (for the same Material used in different models the fee is calculated only once);
- for each combination of Materials/double layer (for the same combination used in different models the fee is calculated only once);
- for resubmission of a Product and/or Material.

Applications effected without corresponding fee payment will not be considered.

Any additional costs associated with the application (e.g customs clearance fees charged to World Aquatics, etc) will be re-charged to the applicants.

7.5.5.1.6 Examination by the Independent Swimwear Expert

The Independent Swimwear Expert examines the applications and notifies her/his decision to World Aquatics normally within 6 weeks from the submission date.

However, the approval procedure for the submitted swimwear, or part thereof, may be subject to delays resulting from the time necessary for the examination process.

7.5.5.1.7 Technical Testing

Technical testing and examination, as needed, is conducted under direction of the Independent Swimwear Expert and the professionals appointed by World Aquatics.

Information related to the test results of specific Samples are communicated to the Applicant concerned, upon request. No results are communicated to any other third party.

The only results relevant for the approval procedure of Swimwear are those obtained by the Independent Swimwear Expert, from the samples submitted with the application, or from additional Samples specifically requested by the Independent Swimwear Expert.

Measurements taken outside of that procedure on the same samples, or others, are not relevant for the Approval Procedure, irrespective of the equipment used.

7.5.5.1.8 Results of the submission

The decision is reported in writing by World Aquatics to Applicants within ten (10) working days from the date of the determination issued by the Independent Swimwear Expert.

In the case of a decision not to approve a submission, the Independent Swimwear Expert identifies the ground(s) for non-approval.

7.5.5.2 Resubmission

7.5.5.2.1 Resubmission of Products

In the event that an application for a Product is not

approved, the applicant shall re-submit the Product/Sample at the next submission available (see rule I.7.5.5.1.4)

The Sample resubmitted shall be the same Sample as the previously submitted Sample, save for the modifications linked with the Independent Swimwear Expert's requirements. Resubmission cannot serve for new Products to be presented that are different from the ones initially submitted.

Applications received after the set deadline will not be considered.

7.5.5.2.2 Resubmission process

The resubmission process shall be conducted in the same way as for the original submission process and the above provisions regarding submission apply *mutatis mutandis*.

An application shall be resubmitted for each concerned Product as per rule 7.5.5.1 and shall include reconfigured Samples with the changes as required by the Independent Swimwear Expert.

7.5.5.2.3 Resubmission fees

The fees remains the same than for a regular submission.

7.5.5.2.4 Special case

In the event that an application for a Product is not approved and the cause of rejection can be easily corrected (e.g seams number, seams/straps design on swimsuit, sharp edge on goggles), the Applicant concerned may resubmit the same Product with the required corrections as soon as possible.

In the case the correction only requires minor examination, World Aquatics, at its own discretion, may not impose any fee.

If the re-submitted Product is considered compliant and approved by the Independent Swimwear Expert, the Product may be included in the Approved List based on the time-line of the initial submission date (please refer to the

explanatory note of 7.5.5.1.4).

Important

The Clause 7.5.5.2.4 does not apply to non-compliances related to permeability or thickness, or to major Construction issues.

7.5.6.1 Thickness Measurement

7.5.6.1.1 Value

- Maximum value: equal or less than 0.8 mm
- Minimum value: equal or superior to 50 % of maximum value
- Tolerance: +/- 0.1 mm

7.5.6.1.2 Equipment

The equipment consists of a reference plate, a disk (parallel to the plate) together with a test gauge capable of measuring the distance between disk and plate with an accuracy of at least 0.01 mm.

• 7.5.6.1.3 Specifications

According to ISO 5084:

- disk size 100 mm² +/- 1 mm²
- (diameter 11.28 mm +/- 0.05 mm)
- pressure 1 kPa +/- 0.01 kPa

7.5.6.2 Permeability

7.5.6.2.1 Value

Minimum Value:

Equal or higher than 80 litres/square meter/seconds (l/m²/s)

Tolerance: +/- 5 % (in the range of Minimum Value)

7.5.6.2.2 Measurement of air permeability

- A flow of air is sucked through the fabric specimen, a tube system and differential pressure transducer. The unit

measures the resultant differential pressure (proportional to volumetric flow), the absolute pressure and the medium temperature. The air permeability of the measured specimen is established based on those values.

- The value of permeability is given in litres/m²/seconds (l/m²/s) for a given material.

7.5.6.2.3 Measurement characteristics

- Measuring area: Diameter 25 mm.
- Differential pressure: 20 Pa
- Measuring range: 0-400 l/m²/s (high accuracy around Minimum Value)
- Definition of stretch: Uniform bidirectional and perpendicular stretch of 25% applied to the fabric (see sketch below)

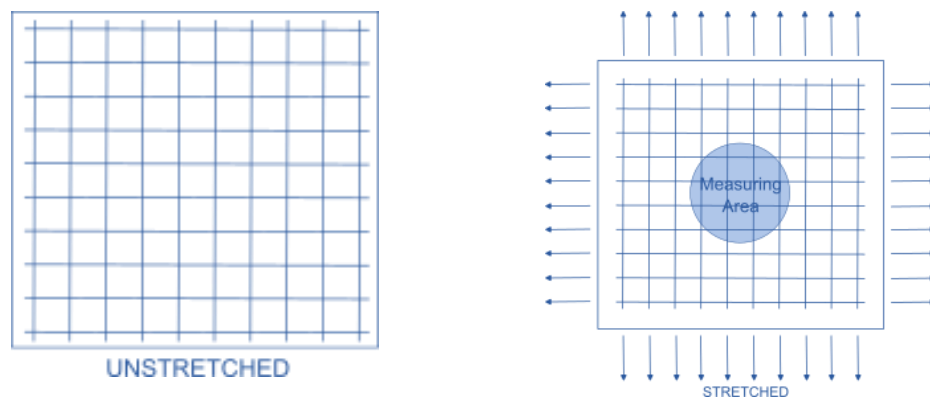

7.5.6.2.4 Conditions

The swimsuit material is tested new and dry.

For accuracy purpose, repeatable tests will be done if the test value is close to the limit.

7.5.7 Approval

7.5.7.1 Validity of Approval

7.5.7.1.1 Approval

An approval is valid upon its notification to the Applicant.

However, notwithstanding the above, approvals will be only effective, i.e. the corresponding swimwear may be used in World Aquatics' competitions and in any other Competitions and at the Olympic Games, from the date of publication of

the current valid List of Approved Swimwear (Competition Regulations Article I.7.4).

The effective date is published on the World Aquatics' website.

7.5.7.1.2 Availability / Commercialisation

7.5.7.1.2.1 Availability

The validity of the approval is further subject to the condition that the swimwear on the list has to be available on the market (available for purchase by federations and competitors) at the latest by 1st January following the publication.

Examples

- A newly approved product included in the List of Approved Swimwear published on 1st September 2022 shall be commercialised no later than 1st January 2023.
- A newly approved product included in the List of Approved Swimwear published on 1st September 2023 shall be commercialised no later than 1st January 2024.

• Upon request, Manufacturers shall provide evidence of date of market availability. If a Product is not available on 1st January of the year in which the approval was to become effective, the corresponding Approval shall be withdrawn from the List of Approved Swimwear. The concerned Applicant may submit an application for relisting on the next yearly List of Approved Swimwear. Such application shall be supported by clear and positive evidence of availability.

7.5.7.1.2.2 Commercialisation

For practical reasons, a product newly included in the yearly Swimwear Approved List could be commercialised and available for purchase 30 days before the publication of the new List of Approved Swimwear.

However the swimwear can only be used in competition from the date of publication of the new List of Approved

Swimwear.

7.5.7.1.3 Approval Changes

Approvals granted remain valid until the relevant criteria for a category of swimwear is changed.

Irrespective of change in the criteria, which will impact on approval as they come into force, the validity of the approvals may however be subject to a maximum period of validity.

If a maximal period of validity is implemented, the concerned swimwear may be resubmitted for re-approval. The rules will provide for a simplified re-approval process.

In the event of introduction of new or amended criteria, all swimwear affected by the application of these changed criteria are subject to re-approval. The Independent Swimwear Expert may however exempt certain types or categories of already approved swimwear from a re-approval. The conditions of such exemption will be decided by the Independent Swimwear Expert. These conditions decided are not subject to any review or challenge.

7.5.7.2 Homologation

7.5.7.2.1 World Aquatics Homologation Label

- The athletes attending World Aquatics-sanctioned competitions must wear the World Aquatics Approved Swimsuits or Wetsuits. The Swimsuits and Wetsuits are subject to be checked by the officials at the occasion of an event.
- The Applicant must use the World Aquatics' Homologation Label in order to indicate that the Product in use has been approved. The Homologation Label shall be placed in a position allowing easy control when worn.
- All Swimsuits of the models-shapes and Wetsuits approved by World Aquatics shall bear appropriate Homologation Label.
- If the swimsuit is in two pieces, each piece shall bear a label. The labels should be printed or affixed to the swimsuits in a manner ensuring that they cannot be removed without destroying the label (to prevent transfers).
- World Aquatics will provide Applicants with a World Aquatics Homologation Label for each approved Product¹

¹ Please note that the World Aquatics Homologation Label is different from the World Aquatics logo and/or other trademarks of World Aquatics. The World Aquatics logo or other trademarks of World Aquatics cannot be used to confirm approval as their

(currently it applies to Swimsuit and Wetsuit, but may be extended to other swimwear in the future). The Homologation Label carries a unique identification number.

Applicants must accept and certify to apply the Homologation Label strictly and only on Products identical to, and fully consistent with, the actual Samples submitted to obtain the approval.

Clarifications related to the homologation label

It is clarified that wetsuits which fulfil the shape requirement can be accepted even if they do not bear a valid World Aquatics Homologation Label provided they effectively and evidently fulfil the requirements of the present Technical & Approval Implementing Rules. This is notably the case for swimsuits made of traditional permeable textile (i.e. open mesh) Material (such as cotton, Nylon, Lycra and the like) with no application of surface treatment closing the open mesh structure and Wetsuits which expressly fulfil the thickness requirement.

Each Homologation Label corresponds to particular model-shape of the Swimsuit or Wetsuit approved by World Aquatics.

The Applicant is entitled to produce the Homologation Label according to the specifications provided by World Aquatics.

Each Swimsuit / Wetsuit of an approved model-shape shall bear a corresponding World Aquatics Homologation Label.

The label has to be produced with high contrast (in white on dark colours, in black on light colours or in blue on light colours).

The size of the label shall respect the reference size of 35 mm x 27 mm (H x W) with a tolerance.

- The Homologation Label shall be printed/tightly affixed (non-removable) on the outside of each piece of the Swimwear.

- The Homologation Label should be printed or affixed in manner ensuring that they cannot be removed without destroying the label (to prevent transfers).
- The Homologation Label can be located on the front or on the back of the Swimwear.

7.5.7.2.2 World Aquatics Approved Package Tag

The general World Aquatics Approved Package Tag can be used on packaging and in product documentation (in a non-prominent manner). Such application shall always be clearly and specifically related to approved Product only. The “World Aquatics Approved Package tag” can only be used in relation with a World Aquatics approved swimwear (Swimsuit, Wetsuit, Goggles, Cap).

The World Aquatics Approved Package Tag is aimed to be printed on hang tags or packages, and not on the product itself. The tag can also be used on the internet/social media and in the product catalogues. However, it always has to clearly and specifically refer to approved swimwear only.

Size and colour of the “World Aquatics approved” tag:

- The printing of the tag should always be done in black and white colours (see examples below).
- The size of the tag cannot dominate on the overall area it is used.

Minimum dimension (H x W):

10.8 mm x 25 mm (with tolerance)

Maximum dimension (H x W):

20.3 mm x 47 mm (with tolerance)

- 62 pixels x 145 pixels (for webpage)

Please note that the “World Aquatics approved package tag” has to be used only as a proof of the conformity for the Swimwear. It shall not be in any case used as a means of promotion or association with World Aquatics.

7.5.7.3 Consistency and Compliance

7.5.7.3.1 Consistency

The Products that are manufactured and used shall fully correspond to, and be consistent with, the Samples submitted to the Independent Swimwear Expert for obtaining the necessary approvals. Inconsistency found in the Products may lead to withdrawal of the approval (see article I.7.5.7.4).

All the parameters measured and recorded during the Approval Procedure notably values for permeability and thickness, are applicable to the Material(s) used in the finished Products and must remain in any event within the limits set under the requirements set in these Technical & Approval Implementing Rules.

The Applicants shall certify and be responsible for the fact that the Swimwear they manufacture and bring on the market as approved Swimwear (and bearing Homologation Label), are fully consistent with the Products and the actual Samples submitted for approval.

Approved Swimwear shall not be modified, treated or processed in any way after their production. Any modification before use such as and including impregnation is prohibited.

Clarifications related to the modification

If a swimsuit or a wetsuit is modified or repaired by the athlete or any other person (e.g. by adding a new piece of fabric, or by repairing a seam, etc), the amended swimsuit/wetsuit will no longer be approved swimwear and will lose its approval/homologation. As a consequence, the athlete will not be allowed to use it during a competition listed in Rule I.7.1

7.5.7.3.1.1 Clarification regarding consistency and minor modifications of Approved Swimsuits models.

The principle that swimsuits which are effectively manufactured and used shall be and remain fully

consistent with the corresponding approved model is an essential element of the approval system under the current regulations.

▶ **Modifications of approved models are as a rule excluded.**

However, minor modifications done by the Manufacturer of the model which do not affect essential features may be exceptionally allowed by the independent swimwear expert, based on a reasoned application of the Manufacturer and when the modification(s) appear(s) to be needed.

The minor modification is to address issues, which had not been identified prior to full manufacturing stage and actual use of the swimsuits (e.g. swimsuits breaking due to too weak seams, material transparent when worn, necessity to protect sensitive parts with lining, discontinued Materials, etc.).

It is clarified that the exceptional acceptance of modifications shall not be used to submit improvements of approved swimsuits models,

Material improvements of existing models are normally to be submitted through new applications in the course of the normal approval process.

▶ **The decision to allow the modification(s) or not is at the entire discretion of the Independent Swimwear Expert, and is not subject to any challenge.**

The above applies *mutatis mutandis* in relation with wetsuits, caps and goggles.

The Applicant must expressly confirm that the modification(s) has (have) not been implemented yet in regard to swimsuits already in use and must also confirm that, in case the modification(s) is (are) approved, only the modified models will be henceforth manufactured and distributed.

The applicable limits in regard of tested values and all other requirements and criteria must be observed in any

event. If tests have to be performed (for example, use of a different lining), the Manufacturer will have to bear the corresponding costs. Advanced payment of the costs may be required as a condition to handle the application.

In the event, modification(s) of an approved swimsuit model is (are) accepted, the corresponding samples will be kept as new reference for the concerned approval number. If swimsuits consistent with the initial submission are in use, the initial samples will be kept as well.

7.5.7.3.2 Compliance

Compliance checks can be done by World Aquatics at any time on swimwear presented as approved in competition or otherwise.

Upon request of World Aquatics, the Applicant shall deliver additional Samples of approved Products as brought on the market for compliance checks.

7.5.7.3.3 Control during Competitions

7.5.7.3.3.1 Before the race starts

The referee may check the compliance of the swimwear in the call-room.

If the swimwear is not compliant, the swimmer may not be allowed to take part in the race, or may be offered the opportunity to use another Approved Swimwear (at the swimmer's charge).

In addition, at the request of World Aquatics' designee, swimmers may be requested to submit their swimsuits for out-of-competition testing.

7.5.7.3.3.2 After the race

Swimwear may be inspected following the completion of a race by the World Aquatics' designee

The competition results achieved with non-compliant Swimwear, and in particular with tested values (thickness

or Permeability) non-compliant with the values mentioned in these Rules are subject to disqualification.

The disqualification of results applies to the results achieved at the race (refer to Specific Definitions) after which the control was conducted or otherwise determined. The decision regarding a potential disqualification may be issued by the World Aquatics based on a technical report issued by the World Aquatics Technical Officials, World Aquatics' designee or the Independent Swimwear Expert.

The concerned competitor and the concerned Applicant shall be heard prior to issuance of the decision.

The application of the articles I.7.5.7.4 is reserved.

7.5.7.4 Withdrawal of Approval

The validity of an approval is based on the fact that any and all the products brought on the market as World Aquatics approved swimwear, are fully consistent with the models and the actual Samples submitted to obtain the approval.

Upon request of World Aquatics, the Applicant shall deliver additional Samples of approved Products as brought on the market for compliance checks.

If swimwear presented as an Approved Product are found, during competitions or otherwise, to be not fully consistent with the Products and the actual Samples submitted for their approval (and this is not linked with modifications made outside the control of the Applicant), the approval may be withdrawn.

The decision to withdraw the approval will be issued by World Aquatics after having heard the Applicant concerned.

In case of necessity (e.g. major event in course), the Executive of World Aquatics may provisionally suspend an approval before hearing the concerned Applicant.

7.5.7.4.1 Withdrawal fee

A withdrawal fee of \$ 10'000 - per product will be due by the concerned Applicant.

The payment for withdrawal should include the Withdrawal fee as well as all related costs beard by World Aquatics, including but not limited with cost of purchased samples, cost of expertise, laboratory tests and required consultancy.

Furthermore, any new or pending application(s) by an Applicant will not be considered until the resolution of the case.

7.5.7.4.2 Re-approval

Application for re-approval for a withdrawn Product is to be effected through the normal process for approval and the application will be held as a new submission and handled accordingly.

As a condition for re-approval, the concerned Applicant shall bring evidence supporting the fact that it will guarantee consistency between Samples and Products effectively on the market.

7.5.7.5 Customisation

No customisation of a standard Product is permitted.

Individual body fitting (tailor-made Products) is authorized:

- a) if the service is accessible on the market to any athletes;
- b) Materials, Construction and Configuration of the tailor-made product are identical to the standard Product;
- c) the adjustment can only be done by the Manufacturer at the time of the production of the Swimwear (e.g a standard Product cannot be untucked to be adjusted).

7.5.7.6 Exemption of formal Approval

The Independent Swimwear Expert may issue an exemption from formal approval in respect to swimwear which can be determined as obviously compliant following general and easily checked objective criteria.

Conditions of such exemption will be published by World Aquatics. They are not subject to any review or challenge.

7.5.8 Exclusion of Liability / Indemnity

7.5.8.1 Exclusion of liability

To the full extent permitted by law, the Applicant expressly waives any claim against World Aquatics, its officers, employees, Independent Swimwear Expert and/or any Committee Members arising out or in connection with the approval process set forth in these provisions.

7.5.8.2 Indemnity

The Applicant shall indemnify and keep World Aquatics, its employees, and/or the Committee Members harmless against claims, damages or costs (including reasonable attorney's fees) arising out of or linked with claims by third parties based on the approval of Applicant's Product(s) and/or use by the Applicant of the approval notice.

7.5.9 Arbitration

Any dispute (including i.e. challenge of the decisions of the Independent Swimwear Expert and/or of the World Aquatics Executive, decision or disputes in connection with payments or other disputes) in connection with an approval procedure or otherwise in connection with approvals pursuant to these rules shall be exclusively submitted to the Court of Arbitration for Sport (CAS) in Lausanne in accordance with the CAS arbitration rules.

Disputes over payments of less than \$ 100'000.- shall be submitted to a single arbitrator. Swiss law shall apply as substantive law.

For the avoidance of doubt, criteria set forth in these rules shall not be subject to review. The same apply to conditions for exemptions.

7.5.10 Specific Definitions

Construction: the act or result of putting different things together

Configuration: an arrangement of elements in a particular form, figure, or combination

Independent Swimwear Expert: Means a biomechanical or other suitably qualified independent expert

Material: all physical material/fabric used to produce every element of the swimwear.

Product: Piece of swimwear of a certain design/shape/material (to give examples: men classic, women closedback, goggles, cap, etc...). The end result of the manufacturing process, to be offered to the marketplace to satisfy a need or want. Considering that the product is the end result of the manufacturing process it can consists of one or many elements. All the elements of the product have to be fixed, attached to each other and have to have practical meaning according to the product functionality.

Product Line: The number of products that have similar construction and only vary in colours, sizes and shapes. Any variation in colours, shapes and sizes should not lead to any change of physical / technical parameters of the material the product consists of.

Examples: One Product Line of the swimsuits can include number of products of different shapes such as: Classic (Men), Pants-Short (Men), Pants-Long (Men), Full-Knee (Men), Full- Long-Leg (Men), Classic (Women), Full-Knee (Women), Full-Long-Leg (Women) as well as any possible modifications of the basic shapes (Open/Closed back).

Race: a single race in swimming (50m Freestyle, 4x100m Freestyle Relay, etc.) or in open water swimming (10km, Team Relay)

Sample: A particular Product and/or a piece of material used in Product construction of swimwear being submitted for the approval process.

Submission Date: The last date by which an application for approval shall be received by World Aquatics in order to be accepted for approval process.

Swimwear: a swimsuit, a wetsuit, a swim cap or goggles.

8. ADVERTISING IDENTIFICATION

8.1 Advertising identification appearing on swimwear, pool deck equipment and official's uniforms at World Aquatics Championships and World Aquatics Competitions, with exception for World Aquatics Masters Championships, is permitted as mentioned under in this Section.

8.2 Swimsuits

One (1) manufacturer's logo of a maximum size of 30cm² when worn. Where one-piece suits are used, two (2) logos of the manufacturer shall be permitted, one above the waist and one below the waist of a maximum size of 30cm² each when worn. These two (2) logos of the manufacturer shall not be placed immediately adjacent to each other. Where two-piece suits are used, the two (2) logos of the manufacturer shall be placed on one piece each.

The manufacturer's logo has to be calculated taking into consideration the entire surface of the logo, as shown below:



One (1) sponsor's logo of a maximum of 30cm² when worn.

One (1) flag and one (1) country name or code of a maximum size of 50cm² when worn. Repetitions of the national flag, elements thereof or, the colours of the national flag, included as a design element of the swimsuit, shall not be considered under this rule.

Examples:



8.3 Wetsuits

The manufacturer's logo may appear on the front, and/or back,

and/or sides of the wetsuit, of a maximum combined size of 80cm² when being worn. This manufacturer’s logo space is allowed both on the inside and outside of the wetsuit. If the manufacturer wishes to have two or more logos on the front, back or sides, the combined total area must not exceed 80cm².

The size of the logo(s) shall be calculated taking into consideration the entire surface of the logo(s), as shown in the examples below:



One (1) sponsor’s logo (may appear on the front of the wetsuit) of a maximum of 30cm² when being worn.

There must be a minimum clearance space of 1.5cm around all marks on the

wetsuits, including any manufacturer’s logo(s) and/or sponsor logo.

There shall be no marks or design/graphic elements on the upper arm or shoulder articulation area of the wetsuits, to allow for the clear application of the competitor race number.

8.4 Product Technology Identification

Where one-piece suits (swimsuits or wetsuits) are used in competition, two (2) Product Technology Identifications shall be permitted, one above the waist and one below the waist, of a maximum size of 10 cm² each when worn, however these identifications shall not be placed immediately adjacent to each other, nor immediately adjacent to any manufacturer's logo. Where two-piece suits are used, one Product Technology Identification may be placed on each piece.

Other clothing: One additional identification allowed on clothing, limited to Product Technology Identifications, with a maximum size of 10 cm².

Product Technology Identifications means the technical identification (which shall not include any identification of the manufacturer, or any

part thereof) used on clothing to identify any fabric technology.

8.5 Swimming Caps

One (1) manufacturer's logo of a maximum size of 20cm² on the front.

One (1) flag and/or country name (code) of a maximum size of 32cm². The side on which the flag and country name (code) shall be printed will be advised by World Aquatics.

For World Aquatics Championships one (1) World Aquatics Partner's logo of the size decided by World Aquatics on a case by case basis. The side on which the Partner's logo shall be printed will be advised by World Aquatics.

Note: Caps for Open Water Swimming are defined under Rule I.8.6.

Current World Aquatics Swimming Cap Rules

VISUAL PURPOSES ONLY - NOT TO SCALE

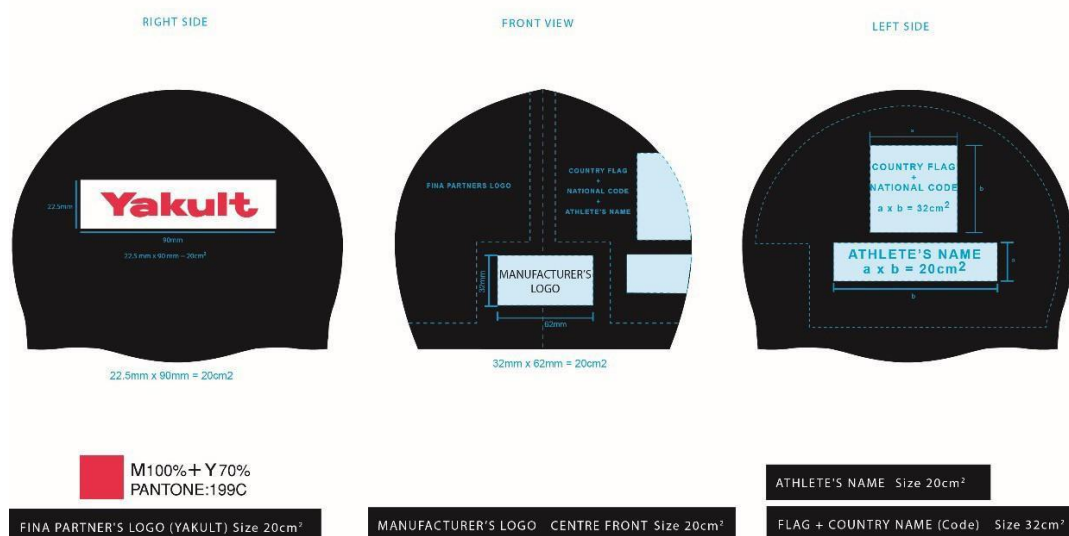

For World Aquatics competition, one (1) flag and/or country name (code) of a maximum size of 32cm² can be printed twice (meaning that the flag and country name can appear on both sides of the cap). This to be advised by World Aquatics whenever applicable.

Competitor's name of a maximum size of 20cm². The competitor's name shall be printed on the same side as the flag and country name (code). Printing the competitors' name isn't compulsory.

It is permissible to wear two (2) caps. Both caps must comply with the

advertising rules.

8.6 Open Water Swimming Caps

In all Open Water events it is mandatory for the cap to display on each side the "national-three letter code" and may display the swimmer's national flag or the swimmer's name. The country code shall be a minimum of 8cm in height. Caps meeting the specifications of I.8.5 are not acceptable except for one (1) manufacturer's logo of a maximum size of 20cm² on the front.

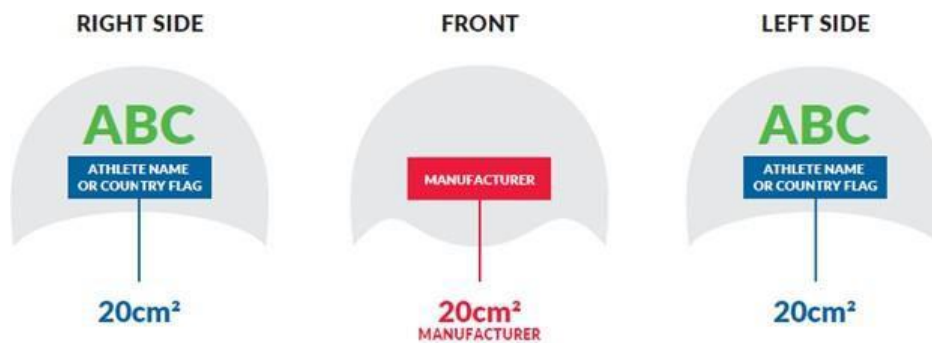

ABC NATIONAL - THREE LETTER CODE
Shall be a minimum of 8 cm in height

20cm² MANUFACTURER'S LOGO
Centre Front / Size 20 cm²

20cm² ATHLETE'S NAME OR COUNTRY FLAG
Centre Side / Size 20 cm²

Athlete's name of a maximum size of 20cm²: The competitor's name shall be printed under the country name (three letter code). Displaying the competitor's name is not compulsory.

8.7 Water Polo Caps

One (1) country code of a maximum height of 4cm on the front side of the cap.

One (1) manufacturer's logo of a maximum size of 6cm² on the front, back or side

One (1) player number of a maximum height of 10cm on both sides of

the cap One (1) country flag of a maximum height of 4cm on the back side of the cap

One (1) sponsor logo (at the discretion of the NF) of a maximum size of 6cm² on the back side

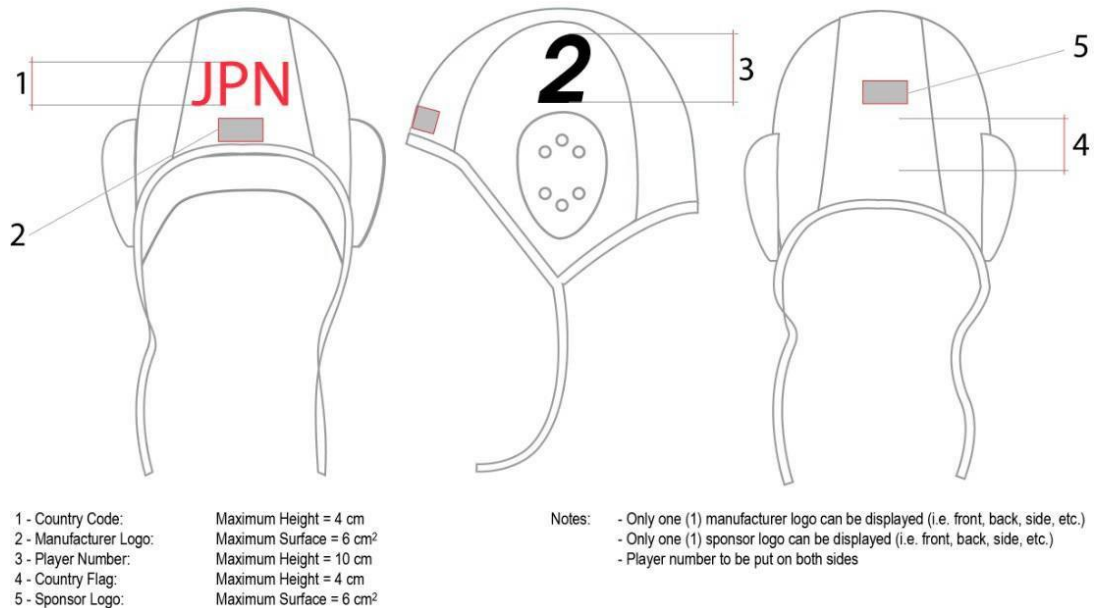

In addition to the above, please refer to Rule VI.APPENDIX B.4.

8.8 Goggles

Two (2) manufacturer logos of a maximum size of 6cm² each are allowed on goggles but only on the spectacle frame or band.

8.9 Competitors Bibs

The maximum size of the Bibs shall be 24cm (width) x 20cm (height).

The height of the digits on the Bibs shall be no less than 6cm and no more than 10cm.

The maximum height of the identification above the digits shall be 6cm. The

identification may display the name/ World Aquatics Partner's logo.

The maximum height of the identification below the digits shall be 4cm. The identification may display the name/logo of the Host City and the year.

The Bibs shall be printed in suitable colours in order to ensure

maximum visibility of the digits.

The Bibs must be worn fully visible during Competitors' introduction and award ceremonies.

A Competitor removing the Bib before being presented at the start of an event or before completion of the medal ceremony may be disqualified.

Only one World Aquatics Sponsor may be displayed on Bibs. However, there may be one sponsor for men and another for women at the same Championships.

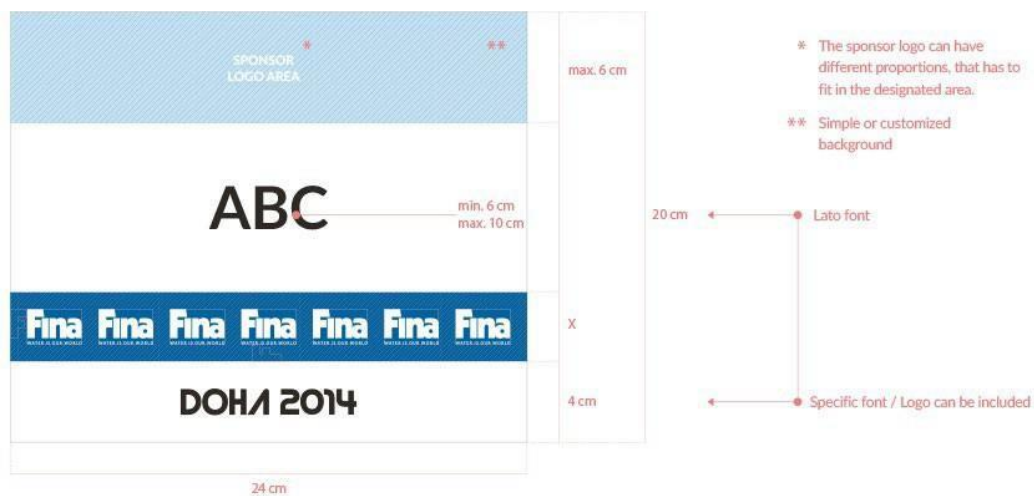

| Bib | Presentation Semi-Final | Presenta tion Final | Award |
|------------|------------------------------------|--------------------------------|--------------|
| SW | Yes | Yes (+ Relay) | Yes |
| DV | Yes | Yes | Yes |
| HD | Yes | Yes | Yes |
| AS | Yes | Yes | Yes |
| WP | N/A | N/A | Yes |
| OWS | N/A | N/A | Yes |

- Each competitor at World Aquatics Championships and World Aquatics competitions must wear on the chest over their tracksuit such advertising as supplied by World Aquatics when being introduced prior to the start of each event and during the victory ceremony.

8.10 Pool deck equipment

A maximum of two (2) advertising identifications of which one shall be of the manufacturer and the other one of a sponsor are permitted, with a maximum size of 40cm² each when worn for any of the clothing items listed below, and a maximum size of 6cm² each for any of the accessories and equipment items listed below.



Identification on clothing must be placed on the top breast side so that Bibs requested by World Aquatics may be worn well visible below.

For upper-body clothing items only, the manufacturer's logo (being a design mark of maximum of 8cm in width) may additionally be

displayed in the form of a strip in one of the following positions:

- a) around the bottom of both sleeves; or
- b) centered down the outer seam of both sleeves (from the collar across the top of the shoulders down to the bottom of the sleeve).

SAMPLE



For lower-body clothing items only, the manufacturer’s logo (being a design mark of maximum of 8cm in width) may additionally be displayed in the form of a strip centered down the outer seam of both legs (from the waistband down to the bottom of the leg).

SAMPLE

- T-shirt (40cm²)
- Polo shirt (40cm²)
- Casual shirt (40cm²)
- Sweatshirt (40cm²)
- Bath robe (40cm²)
- Tracksuit top (40cm²)
- Pants (40cm²)
- Shorts (40cm²)
- Skirts (40cm²)
- Windbreaker (40cm²)
- Towels (6cm²)
- Baseball caps (6cm²)
- Hats (6cm²)
- Socks (6cm²)
- Footwear (6cm²)
- Bags (not greater than 10% of the surface area of the item, to a maximum size of 60cm²)



- 8.11** Any body advertisement, in particular displayed on the competitor's body, is forbidden in any way whatsoever.
- 8.12** Advertising for hard alcohol (greater than 15% alcohol), tobacco-based products, vapor-based smoking and sport gambling is prohibited. However, advertising for soft alcohol (less than 15% alcohol) and games of chance (e.g. state-sponsored lotteries) are allowed.
- 8.13** Any advertising identifications which are not indicated in these regulations are not permitted. In the event that any clothing or other items of equipment contravenes these regulations, the competitor must immediately remove the offending item(s) and replace it/them with clothing that complies with World Aquatics Rules. In the event that the breach is not immediately remedied the competitor may be requested to wear attire provided by the event organizer.
- 8.14** World Aquatics reserves the right to request Federations taking part in World Aquatics Championships and World Aquatics Competitions to present any advertising identification in this rule for examination and approval of World Aquatics prior to the event in question.

9. MEDICAL RULES

World Aquatics adopted the Olympic Movement Medical Code in 2008. All World Aquatics medical regulations, guidelines or protocols, follows the general principles of the Olympic Movement Medical Code.

The latest versions of the Olympic Movement Medical Code can be found on the IOC Medical and Scientific Commission website.

<https://olympics.com/ioc/medical-and-scientific-commission>

The Olympic Movement Medical Code applies to all athletes in the sports activities governed by World Aquatics, in competition as well as out of competition.

World Aquatics is free to grant wider protection to their athletes.

The Olympic Movement Medical Code applies without prejudice to the national and international ethical, legal and regulatory requirements

that are more favourable to the protection of the health, rights and interests of the athletes.

9.2 Medical Requirement for World Aquatics Events

Scope of Medical Coverage

The organising committee shall organise the medical care to cover any emergency issues, acute injury and illnesses of athletes and World Aquatics Family that may occur during the period of the World Aquatics Event and to respond to injuries and illness that arise to any one at the competition and non-competition venues.

Limits

This document describes planning and operational requirements for the LOC (Local Organising Committee) Medical Services, and explains the obligations, responsibilities and planning processes.

However, it does not address how such medical services will be delivered during the period of the Event. This limitation recognizes the variability of regulatory governance and clinician roles existing across the global medical community.

Chronic injury and illness are not covered by the LOC Medical Services and World Aquatics is not responsible for any failure to diagnose or treat any chronic injury or illness.

Date of Operations

Athlete medical services must be provided on all days of official training and competition, beginning one hour before training or competition begins.

References

These requirements contain numerous elements, information, and references from:

- IOC Manual of Emergency Sport Medicine, 2015, McDonagh D. and Zideman. D.
- ASOIF Health Care Guidelines for International Federations, 2020

9.2.1 Background information

World Aquatics is responsible for the aquatic sports of swimming, artistic swimming, diving, high diving, water polo and open water swimming.

While aquatic sports are generally quite safe from a medical perspective, there is obvious potential for drowning in all water-based sport. Each World Aquatics' discipline also carries potential for injury unique to that sport, as summarised in the following section. Knowledge of aquatic sports medicine enables hosts of World Aquatics' events to consider the provision of appropriate clinical support in their planning.

World Aquatics places the physical and mental health of athlete stakeholders as its top priority.

9.2.1.1 A guide to common injuries

| | |
|----------------------------------|--|
| Swimming: | overuse injuries |
| Artistic Swimming: | traumatic (contact) injuries, fainting (hypoxia) from breath-holding |
| Water polo : | contact injuries |
| Diving & High Diving: | high velocity traumatic injuries |
| Open Water Swimming: | cold and heat stress, skin irritation from UVL exposure or bites |

9.2.1.2 Injury Profile

The literature on injuries to aquatic athletes characterise overuse injury as predominant, with the shoulder, knee and lower back as the most common injury sites. This mechanism of trauma is most common in swimming, secondary to repetitive use.

In terms of impact or contact injury, the head and face are the most vulnerable body sites in water polo and artistic swimming, while injuries to the digits (particularly fingers) are also possible.

Although relatively rare, high-velocity impact injuries are most common in diving, particularly high diving.

9.2.1.3 Essential skills required from the Medical Team

Given the above information, the medical team should have an understanding of aquatic sports medicine, with obvious proficiency in water rescue procedures.

9.2.1.4 Overview of Competition Planning

Effective planning for athlete health care must be based on a clear understanding of the size and scope of the World Aquatics Event. From a pure logistical standpoint the medical plan must consider:

- The duration of the event
- The spread of venues (training + competition)
- Environmental conditions (outdoor – indoor)
- Number of participants

9.2.2 The Sports Medicine Committee

The Sports Medicine Committee (SMC) is responsible for advising on various medical aspects across each aquatic disciplines. The SMC comprises physicians with specialist expertise and wide clinical experience in all aspects of aquatic sports medicine.

The specified duties of the SMC are as follows:

- to provide specialist expertise to the Bureau in the form of recommendations on all matters relating to aquatic sport science, medicine and athlete participation following a medical incident
- to ensure World Aquatics rules relating to athlete physical and mental health and well-being reflect current clinical best practice.
- to advise on venue suitability, where applicable, in relation to sanitation and water quality, submitting as necessary, timely updates to the Bureau,
- to ensure safety in all aquatic sport, recognising the unique characteristics of each discipline.
- to advise Local Organising Committees in the provision of appropriate medical care for World Aquatics athletes and Officials at World Aquatics Competitions.

9.2.2.1 Roles and Duties

9.2.2.1.1 Prior to World Aquatics Events

The SMC or its representative will liaise with the LOC Medical Team to ensure adequate planning for the delivery of Medical Coverage.

The World Aquatics Medical Delegate appointed to an event may be briefed on the points to be checked during a World Aquatics Event.

9.2.2.1.2 During the World Aquatics Events

The World Aquatics Medical Delegate is responsible for oversight of all the medical aspects of the event ensuring the health, safety and well-being of athletes and officials. World Aquatics Medical Delegate(s) does not practise medicine during World Aquatics Events. They only have a consultative and expertise role.

The local Chief Medical Officer is responsible for delivering a medical plan as outlined in these World Aquatics Medical Requirements and the relevant regulations for World Aquatics events.

Important note: Checks carried out by the World Aquatics Medical Delegate are limited to the compliance with the World Aquatics regulations and do not shift the responsibility for the medical services from the organizer to World Aquatics.

Findings of non-compliance shall be notified to the LOC who shall take appropriate measures and remain exclusively responsible for the safety at the event under the World Aquatics rules and the terms of the organization agreement.

The World Aquatics Medical Delegate (or its designee) will:

- Liaise with the Chief Medical Officer before the event to ensure that an appropriate medical plan is in place in keeping with the World Aquatics Medical Requirements.
- Provide aquatic-specific knowledge and advice to the host medical teams as needed.
- Ensure, with the Chief Medical Officer, that the venue is free of significant risks or hazards.
- Ensure, with the Chief Medical Officer, that emergency transport, an emergency secondary care facility and After-Hours care are available.
- Ensure, with the Chief Medical Officer, that any public health requirements regarding communicable diseases are followed.
- Confirm that the Medical Treatment Area is suitably staffed and equipped
- Confirm that lifeguards are in place while athletes are in the water
- Liaise with the Chief Medical Officer on a daily basis to

- receive an overview of injuries and illness encountered.
- Confirm availability of water and snacks and, where appropriate, nutritious meals for the athletes
- Support the presentation of the medical plan at the World Aquatics Technical Meeting
- Be a person of contact for medical issues, pertinent to World Aquatics, for attending teams.
- Visit athletes (if authorised) who have been evacuated to medical care centres/hospitals
- Coordinate on-site research projects initiated by the SMC and World Aquatics.

At Open Water Swimming events

If present at Open Water Swimming events, the World Aquatics Medical Delegate will:

- 1) Liaise with the World Aquatics Safety Delegate, World Aquatics TOWSC Delegate and the local Chief Medical Officer regarding all aspects of participant safety at the competition venue.
- 2) Review the water quality results prior to arrival at the competition site, as well as subsequently from the day of competition (if available).
- 3) Ensure, with the local Chief Medical Officer and World Aquatics Safety Officer, that the environmental conditions are acceptable for the competition, water quality and temperature in keeping with current published World Aquatics standards.
- 4) Ensure, with the local Chief Medical Officer and World Aquatics Safety Officer, that there are sufficient Medical Boat with medical staff (place in the water with emergency equipment and supplies, including radio for communications), with a defined evacuation point/s to emergency medical support personnel and ambulance evacuation if necessary.

At High Diving events

If present at High Diving events, the World Aquatics Medical Delegate will:

- 1) Liaise with the World Aquatics High Diving Delegates and the local Chief Medical Officer regarding all aspects of participant safety at the competition venue.
- 2) If applicable, review the water quality results prior to arrival at the competition site, as well as subsequently from the day of competition.

9.2.2.1.3 After the Event

The World Aquatics Medical Delegate will submit a post-event report on all medical aspects of the event, together with recommendations for future improvement.

9.2.3 Specific Medical and Safety Regulations

9.2.3.1 Concussion Protocol for any World Aquatics sport

In the event of concussion or suspicion of concussion, the Sport Concussion Assessment Tool (SCAT5) must be used to evaluate concussions. The SCAT5 is a standardized tool for evaluating concussions designed for use by physicians and licensed healthcare professionals. The SCAT5 cannot be performed correctly in less than 10 minutes. SCAT5 is to be used for evaluating athletes aged 13 years and older.

The latest version of SCAT and Consensus Statement on concussion in sport can be found here.

<https://bjsm.bmj.com/content/bjsports/early/2017/04/26/bjsports-2017-097506SCAT5.full.pdf>

<https://bjsm.bmj.com/content/bjsports/early/2017/04/26/bjsports-2017-097699.full.pdf>

9.2.3.2 Decision-making on return to the competition following injury or other medical reasons

Based on the recommendation of the Sports Medicine Committee and/or the LOC Medical Team/local medical authorities, and in conjunction with the athlete and NF Medical Team, the Bureau, as per Constitution Rule IV.17.1, may remove an Athlete from an aquatics competition and/or take any other appropriate measure if such participation poses a risk for the health and safety of such Athlete or any competitors.

9.2.4 Medical Plan and Health Care

9.2.4.1 Medical Plan

The Local Organising Committee (LOC) shall submit a Medical Plan to World Aquatics for approval before the Event. The deadline to submit the Medical Plan will be defined in the Operational Requirements. The plan shall comply with all requirements of these regulations.

Each Medical Plan shall be reviewed by the Chair of the Sports Medicine Committee, who shall approve, modify, or reject the submitted Medical plan.

Implementation of the Medical Plan at the Event

The MD shall inspect the competition venue with the LOC Chief Medical Officer (CMO) or Venue Medical Officer (VMO) prior to the first day of training to ensure adequacy of the medical/safety plan.

The MD, in cooperation with the Technical Delegate (TD) and the LOC CMO or VMO, may modify, postpone, or cancel the competition whenever the approved safety plan is inadequate to protect the safety of athletes.

9.2.4.2 LOC Chief Medical Officer (CMO) and LOC Medical Team

The Local Organizing Committee (LOC) shall designate an appropriately qualified physician as a Chief Medical Officer (CMO) for the World Aquatics' event as soon as the Event is confirmed by World Aquatics.

For World Aquatics Championships and World Aquatics Swimming Championships, the CMO shall be nominated twelve (12) months before the beginning of the Event.

She/He should have experience with Aquatic Sports preferably.

She/He must speak English.

This individual will be responsible for the following tasks:

- Organization of the complete medical care system
- Coordination of medical care personnel
- Ensuring the quality of the medical services and equipment
- Establishing an emergency care pathway
- Communication between the Chief Medical Officer and World Aquatics (Medical Department or SMC) is essential prior to the event to ensure adequate and appropriate planning for the medical needs of the competitive event.

The CMO is responsible to ensure that an adequate number of appropriately qualified health care personnel are available and hired for the training and competitive sessions of the World Aquatics' event. Depending on the size of the Event, she/he may appoint Deputy Medical Officer(s) and/or Medical Venue Manager(s) who can help the CMO in the duties.

9.2.4.3 Health Care Personnel (HCP)

For all training and competitive sessions, health care personnel should be available on site whenever athletes have access to the venue. They should have some sport medicine skills or experience.

The numbers and type of HCPs will depend on the size of the event but shall include:

- Primary care / Sports Medicine Doctor
- Lifeguards
- Paramedics

In addition to the above, HCPs may also include:

- Nurses
- First aid responders
- Physiotherapists
- Massage therapists
- Athletic trainers

All World Aquatics Events should have trained and qualified lifeguards poolside for all training and competitive sessions.

They will be responsible for any in-water retrieval of an athlete in difficulty.

At the World Aquatics Championships, it is recommended to have at least one English-speaking doctor assigned to each venue.

No training nor competitions could start without the presence of HCPs.

9.2.4.3.1 Summary Table of recommended HCP

The recommended numbers hereafter only represent the staff that must be present on-site. To organise efficient shifts/turn-over, the total pool of recruited HCPs shall be larger, especially for long Events.

9.2.4.3.1.1 Lifeguards

A minimum of two (2) lifeguards per swimming pool (competition pool or training pool) is required. Specific requirements are described in the medical section of each Sport Chapter.

The number of lifeguards should be increased proportionally to the number of athletes to cover multiple casualties at the same time.

Daily practice of water retrieval is recommended.

9.2.4.3.1.2 HCPs - Single Sport Event

Venue

| | |
|--|-----|
| Primary care / Sports Medicine Doctor: | 1-2 |
| Paramedics: | 2 |
| Nurse(s): | 1 |
| Physiotherapists | 1 |
| Massage therapists | 1-2 |

Training Venue (if applicable)

| | |
|-------------|---|
| Paramedics: | 1 |
| Nurse(s): | 1 |

9.2.4.3.1.3 HCPs - Single Sport World Championships

Venue

| | |
|--|-----|
| Primary care / Sports Medicine Doctor: | 2 |
| Emergency physician: | 1 |
| Paramedics: | 6-8 |
| Nurse(s): | 2-3 |
| Physiotherapists | 1 |
| Massage therapists | 1-2 |

Training Venue (if applicable)

| | |
|--|-----|
| Primary care / Sports Medicine Doctor: | 1 |
| Paramedics: | 1 |
| Nurse(s): | 1-2 |

9.2.4.3.1.4 HCPs for Multiple Sports Event

Venues

| | |
|--|------|
| Primary care / Sports Medicine Doctor: | 4-5 |
| Emergency physician: | 2 |
| Paramedics: | 8-10 |
| Nurse(s): | 6-8 |
| Physiotherapists | 3-4 |
| Massage therapists | 3-4 |

Training Venue (if applicable)

| | |
|--|-----|
| Primary care / Sports Medicine Doctor: | 1 |
| Paramedics: | 1 |
| Nurse(s): | 1-2 |

9.2.4.3.1.4 Psychologists

The LOC is strongly recommended to organise the availability of psychologist(s) on call if there is a demand from athletes or any participant.

9.2.4.4 Roles and Duties of the LOC Medical Team

9.2.4.4.1 Prior to the event

- 1) The Medical Team collaborates with World Aquatics in the planning of the medical program and provides the different medical plans.
- 2) They shall undertake a sport & discipline-specific medical risk assessment of all training and competition sites.
- 3) They shall provide a timeline and budget for the organisation of the medical program to the LOC.
- 4) They should organise the medical training of the HCP. In addition, the CMO and/or the Medical Team may pilot the medical plan at local test events and evaluate and revise the plan as required.
- 5) The Medical Team will Liaise with public health authorities to plan event risk mitigation strategies. It shall publish and circulate the public health event risk mitigation strategies. The Medical Team shall ensure that all evacuation and fire procedures for the spectators and the athletes are in place as per local regulations.
- 6) The Medical Team will provide a list of common medications available/not available in the country and will assist the NF Medical Personnel with the drug and equipment importation regulations.
- 7) The Medical Team will assist the NF Team Doctor with their registration and licensing in the host country to provide medical services of their delegation during the World Aquatics Event. This could also be the occasion for the Team Doctor to inform the LOC medical team (in confidence) of any pre-existing medical conditions for their athletes/personnel that may occur during training and/or competition and organise (in confidence) any specific/unique medical treatment that an athlete may require in the event of injury or illness.

8) It shall develop and test an electronic medical encounter system to be used during the Event. Train all members of the LOC medical team to use the system.

9.2.4.4.2 During the event

The Medical Team shall:

- Implement the medical care program in collaboration with World Aquatics for all areas in venues.
 - Field of Play (FoP)
 - Athlete Medical Room
 - Spectator Medical Room
 - Athlete hotels/villages
- Undertake scenario-based practice of the FoP extractions and/or parts of the medical action plan on a daily basis.
- Undertake FoP initial assessment, treatment and evacuation from FoP and appropriate nationally/internationally recognised standards.
- Undertake medical care for athletes who do not have their own medical team healthcare professionals.
- Complete the required documentation for World Aquatics in a daily medical report.
- In collaboration with the World Aquatics Medical Manager, help facilitate the logistics and participate in the venue medical meeting.
- Support the NF medical teams in the provision of medical care for their athletes.
- Implement the World Aquatics safeguarding policies and procedures as applicable.
- Provide the relevant data for World Aquatics injury and illness surveillance/ audit, and/or other research projects.

- Ensure all relevant staff are familiar with the WADA Prohibited List and the requirements for Therapeutic Use Exemptions and Needle Policy (as applicable)
- Maintain medical confidentiality throughout the event.
- Implement the World Aquatics communication policy related to arising athlete health issues (as applicable)

9.2.4.4.3 After the event

The CMO and the Medical Team shall provide a detailed report to World Aquatics reviewing all aspects of the delivery of the medical care program in venues or at hotels/Athletes Village (if applicable).

They shall provide recommendations for improvements for future World Aquatics events and future organisers.

9.2.4.5 Communication and Information

9.2.4.5.1 Between the LOC Medical Team

During the World Aquatics Event, a reliable and confidential communication mechanism is essential to ensure clear and prompt communication between the members of the LOC Medical Team.

The emergency transport vehicles shall be able to communicate directly with FoP Medical Team.

The communication system should have a dedicated, secure channel for the sole use of the medical team. A separated channel shall be dedicated for the medical team in charge of the spectators and the media.

9.2.4.5.2 Between World Aquatics and LOC Medical Team

During the Event, daily meetings shall be organised between the LOC Chief Medical Officer and the World Aquatics Chief Medical Officer/Medical Delegate. It is the occasion to:

- Review reports from NFs, LOC Medical Team and SMC members

- Review medical incidents and advise on appropriate action
- Provide expert advice regarding potential cancellation or rescheduling of an event in case of athlete health risk/safety (e.g., inclement weather)
- Provide expert advice and assistance to the LOC medical team as required/requested

9.2.4.5.3 Team Leaders Meeting for each sport

Before each World Aquatics' Event, a Team Leaders Meeting (TLM) is organised.

The Chief Medical Officer and the World Aquatics Medical Delegate shall be present to present the different aspects of the Medical Plan and Health Care. The safety topics to be included are for instance:

- explanation of the venue layout
- anticipated weather conditions (for outdoor venue)
- water temperature
- description of onsite medical support and availability of hospital care
- outline of evacuation plan

This meeting could be the occasion for World Aquatics Medical Team to present any scientific research or initiatives organised by World Aquatics during the competition such as:

- Injury and illness surveillance/audit research project
- Other athlete health-related research projects
- The academic program (educational seminars) as learners or lecturers
- Safeguarding (harassment and abuse) rules and regulations

Procedure related to the Athlete withdrawals and substitutions for medical reasons shall be reminded during the Team Leaders Meeting.

9.2.4.5.4 Special meetings

Dedicated meeting(s) could be organised to address specific issues (e.g status of an epidemic during the Event).

9.2.4.5.5 Medical Care Guide

Information about the Medical Services should be included in the Event Summons, Information Bulletin and/or Team Leaders Guide.

9.2.4.6 Athletes with no Team Physician

The LOC Chief Medical Officer should provide medical care for those competitors whose teams do not have team physicians.

9.2.4.7 Clear Identification and attire of the Health Care Personnel

It is important that the HCP could be immediately identified on the FoP and at the venue.

It is understood in some countries the HCP may belong to different corporations and shall wear their official attire/uniform. However, when possible and in cooperation with the LOC, a distinctive uniform (e.g a polo shirt, a jacket, a bib) with a “lively” colour shall be provided to the LOC Medical Team and HCPs.

9.2.5. Venue Medical Services

Any individual, if physically present at the venue, should be served by the LOC Medical Programme. There should be separate medical stations and medical response teams for the athletes due to restricted access to athlete preparation and competition areas. The following section only deals with the Medical Services for Athletes, Coaches, visiting Physicians, Team Managers and the Team Aqua. Medical Services for spectators, media, marketing partners, and workforce will be described in the Section I.9.21.

Venue medical care should be implemented at the international standards of ‘*Good Clinical Practice*’. For example, venue medical

personnel should be competent in the latest *Advanced Trauma Life Support (ATLS)* and *Advanced Cardiac Life Support (ACLS)* guidelines. For the assessment and treatment of sport injuries, the *IOC Manual of Emergency Sports Medicine* may be used as a reference tool.

Determination of the requirements for venue medical services for each training and competition venue medical station and Field of Play medical station is contingent upon the sport- and discipline-specific requirements. These requirements are developed following an analysis (Risk Assessment) of the following factors:

- Sport medical risk assessment
- Expected number of athlete participants
- Duration of event

The number and location of the Venue Medical Station may vary as per the size of the event and of the Venue. Sometimes there could be a main Venue Medical Station and a Field of Play Medical Station or Treatment Area.

Athlete medical services must be provided on all days of official training and competition, beginning at minimum one hour before training or competition begins.

9.2.5.1 Venue Medical Station

9.2.5.1.1 Location

The Medical Station is to be designated at each competitive venue (e.g for the six sports venues in the case of the World Aquatics Championships). The area should be clearly identified and be within easy access from the Field of Play (FoP). Access to ambulance transport should also be easily reached from the treatment area.

9.2.5.1.2 Size

The Medical Treatment Area should be adequate in size to accommodate the expected volume of athletes and medical personnel as designated for the specific World Aquatics' event.

For example, at World Aquatics Championships, the facility should be large enough to examine and treat 3 – 4 athletes at any given time.

9.2.5.1.3 Equipment & Staff

The station should be at minimum staffed by a physician and nurse and may include other support staff.

In addition to the provision of medical care, staff duties will include documentation of care; operational and clinical reporting; management of equipment and supplies; communication; and base of operations for the venue's FoP medical teams.

Staffing numbers should support the volume of anticipated medical encounters based on review of previous World Aquatics Events.

The equipment and supply requirements should include at minimum:

- Basic and Advanced Life support equipment. BLS and ALS equipment should include defibrillators, strategically located for quick response
- Evacuation equipment for immobilization of the athlete, transport from the FoP, and transport from the venue
- Orthopaedic soft goods, splinting materials, bandaging, suture kits, etc. that may be required on-site so the athlete can be treated and allowed to return to competition, if clinically appropriate
- First aid supplies
- Ice
- Sealed nutritious beverages, water and snacks.

9.2.5.1.4 Privacy

Provision for adequate privacy to protect that athlete's right to confidential health care is important.

9.2.5.1.5 Security & Access

Access to the Medical Treatment Area should be limited to medical staff, athletes, coaches, visiting physicians, team

managers and the World Aquatics Family. For privacy reasons, access to the media and the public should not be allowed.

9.2.5.1.6 Health Care Personnel

When possible, a secure lounge or lunch/relaxation area for healthcare professional should be organised.

9.2.5.1.7 Pharmacy

The LOC Medical Team shall ensure secure storage for medications, including controlled drugs as per the law of the host country.

9.2.5.2 FoP Treatment Area

9.2.5.2.1 Location

In regard to the location adjacent to the Field of Play (FoP), the following shall be taken into consideration:

- Ease of access to the FoP (i.e on the pool deck, next to the pontoon in Open Water)
- Ease of access to the venue medical station and/or emergency evacuation pathway
- Ability for the FoP healthcare professionals to clearly see the sport activity
- Location protected from media scrutiny as feasible.

9.2.5.2.2 Minimum Equipment

- BLS and ALS equipment
- Evacuation equipment for immobilization of the athlete, transport from the FOP, and transport from the venue

9.2.5.3 Physiotherapy and Massage Services

With the occasion of the World Aquatics Events, the LOC generally provides at free of charge physiotherapy and massages for the athletes.

Physiotherapists and masseurs will be allowed to perform massages on those athletes who do not have a medical team to support them.

The massages that are normally offered are:

- Warm-up
- Recovery
- Unload
- Manual therapy
- Stretches
- Osteopathic adjustments
- Functional bandaging
- Kinesis taping

The necessary physiotherapy equipment (e.g. laser, cryo-laser, ultrasound, etc.) will depend on the space allocated for that purpose in each venue.

Examples of treatment location (figures from Budapest 2022)

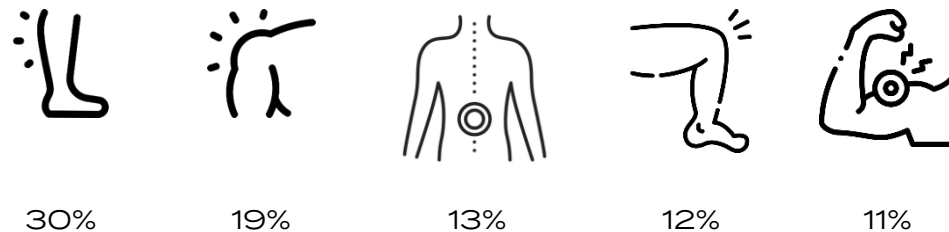

9.2.5.4 Ice-baths

For recovery, it is recommended to offer two (2) Ice baths (minimum width 0.8 m, length 1.2 m, depth 1.0 m) or 14° C water tubs. Alternatively, ice-machines shall be available to teams and athletes for their own tub, or to ice an injury.

9.2.6 Emergency Action Plan and Medical Response Protocol

9.2.6.1 Emergency Action Plan

The Emergency Action Plan should be clearly defined according to the sport-specific risk. It should include:

1. Procedures for how and when to access the Field of Play
2. Emergency treatment and evacuation procedures from the Field of Play:
 - Include educational videos
 - Daily medical scenario training/practice
 - Emergency medical protocol for athlete medical stations
3. Clearly defined protocols for the Field of Play for dealing with:
 - Cardiac arrest
 - Life-threatening injury
 - Death
4. The exit pathway from the Field of Play to either the athlete venue medical station or the ambulance
5. Location of ambulance transportation
6. Location of automatic external defibrillators
7. Completion of medical records, including the maintenance of confidentiality
8. Communication procedures (who, how and when) for communicating with the:
 - Ambulance/emergency medical service
 - Venue medical manager
 - Designated hospital
 - Members of the LOC medical team
 - SMC Chairperson
 - Media

The diagram hereafter is an example of an Emergency Action Plan.

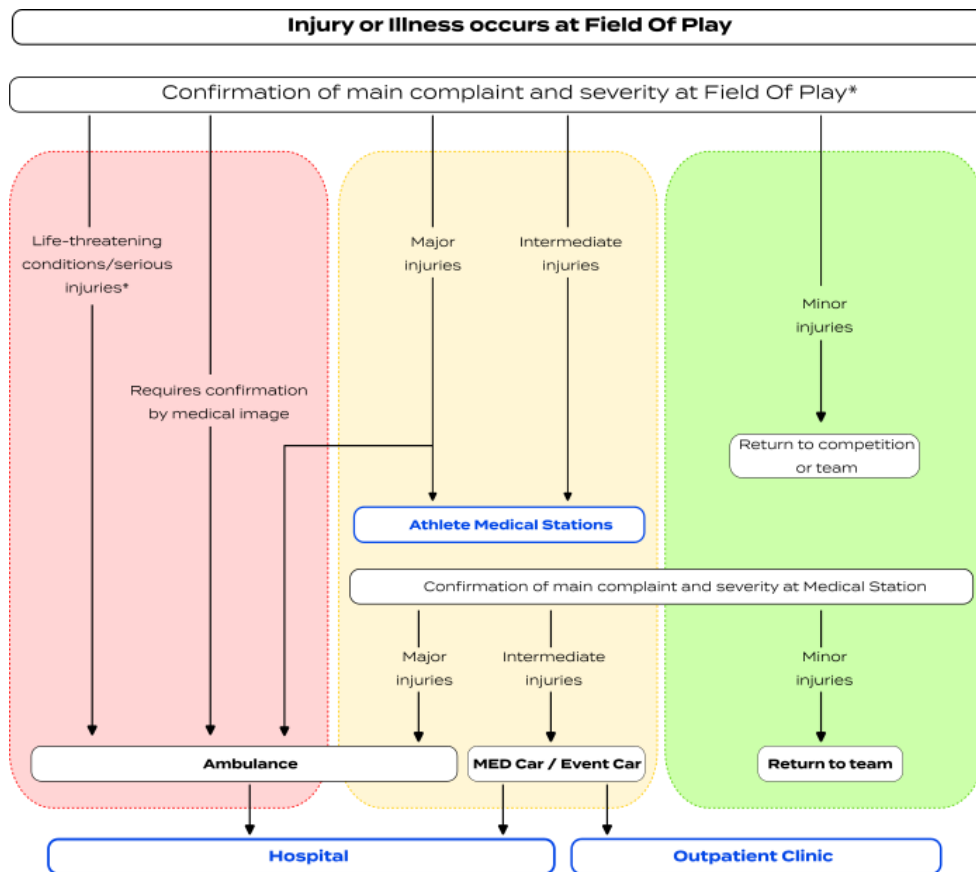

Source: ASOIF Health Care Guidelines for Ifs, 2020

*(*initial life-saving interventions to occur immediately prior to transportation as applicable: e.g., emergency heat stroke should receive immediate intervention at the venue prior to transfer by ambulance)*

9.2.6.2 Medical Response Protocol

Each event is different. When possible, a test event is recommended to evaluate the competition planning, including the medical response and patient evacuation. This must also include safety provisions at training sessions and warm-up.

Past medical experiences from previous events should be shared in advance with the LOC Medical Team to assist preparation.

Team physicians should also contact the CMO in advance with concerns for any athletes requiring special medical attention or specific treatment.

9.2.6.2.1 Contact details

Before competition, the following contact persons must be clearly identified, and their contact details made available:

1. LOC Chief Medical Officer (CMO)
2. LOC Sport Manager
3. AQUA Technical Delegate (TD)
4. AQUA Medical Delegate (MD)
5. AQUA Sport Manager
6. AQUA Medical Manager
7. Each participating Team Leader

9.2.6.2.2 Water Rescue

Clearly identified Lifeguards will be present at all competition and training sessions. They must be experienced in deep water rescue and familiar with water retrieval covering a range of potential medical incidents. Daily practice and rehearsal of athlete extraction is a requirement.

9.2.6.2.3 Competition Medical Response

A direct and permanent supervision of the FoP shall be maintained during the athlete's competition.

If the medical team is reduced due to evacuation of an injured athletes from the FoP to the Medical Treatment Area. A HCP from the warm-up pool could be called to temporary replace the medical staff dealing with the casualty.

A full complement of medical staff should always be maintained at the venue and different swimming pool.

9.2.6.2.4 Preparation

All medical planning should be undertaken well in advance of any scheduled event. During the event, (training and

competition), the LOC CMO or VMO must ensure the following:

- A trained, identifiable, and fully accredited Medical Team.
- A well-equipped, fully-staffed on site medical room.
- A fully-operational communication system linking key personnel.
- A well-rehearsed athlete extraction protocol from pool to medical room.
- Adequate training for all emergency procedures.
- Attention to athlete dignity and confidentiality at all times.
- Availability of emergency transport to identified hospital services.

9.2.6.2.4.5 The Medical Team Response

The initial response depends on the nature of the injury or incident and whether it occurs in the water or on the ground/pool deck.

For any incident in a pool, and the athlete is conscious, he/she can hold onto a flotation device and be towed to the side with lifeguard support.

If unconscious, the athlete must be stabilized on a flotation device. At this point consider need for CPR and cervical stabilisation. A well-rehearsed extraction protocol of the unconscious or injured athlete from the water requires practised teamwork. A primary survey, conducted on the poolside, will identify life-threatening conditions warranting immediate intervention.

When stable, the athlete can be transported to the medical room for a more definitive assessment including potential for closed head injury. Here, the decision for hospital transfer, via ambulance, is made. At all times public and media attention should be managed judiciously and team support personnel must be alerted.

Clearly, the medical team response for a fully conscious, mobile athlete is modified accordingly. The primary assessment on the pool deck will determine the need for urgency and transfer to the medical room. Accompanying NF medical support, where present, may be engaged in this

process. Their knowledge of the athlete may be of inestimable value to local medical staff. However, the NF team support should not interfere with the medical response. In all circumstances, the ultimate management plan for the athlete will derive from consultation between the CMO and NF team support staff as available. Consultation with the appropriate SMC Member is a courtesy and will not influence the management plan or decision to refer the athlete for hospital care.

9.2.7 Emergency Transport Plan

The venue pathways to emergency transport to hospital for medical care that cannot be provided in the venue should be delineated to ensure adequate planning and preparation prior to the event.

° Assurance of appropriate accreditation access is required for all medical personnel to accompany the injured/ill athlete from the FoP or Venue Medical Station to the emergency transport location.

Security and protocol personnel should be aware of the Emergency Transport Venue Pathway and compliant to allow access as required.

The Emergency Transport Plan should include:

- Number of ambulances:
 - Athlete ambulance(s)
 - Spectator ambulance(s)
 - Back-up/support ambulance(s)
- Minimum level of ambulance equipment
- Minimum skill level of ambulance crew (e.g., emergency medical transport/paramedic, ATLS, ACLS etc.)
- Location of ambulances
- Non-emergency medical transport:

In non-emergency situations, the process/means for transportation from the venue to either an outpatient clinic or designated event hospital should be identified (e.g., car, taxi, event transport)

Where the travel time by ambulance between the venue and the nearest hospital with emergency room facilities is longer than one (1) hour, then the safety plan shall require provision for helicopter transport.

9.2.7.1 Sports Requirements

9.2.7.1.1 Swimming / Water Polo / Artistic Swimming

It is recommended that the ambulance be located on site at the competitive venue during training and competitive sessions. If emergency response times can be guaranteed to within a few minutes than use of off-site ambulances is acceptable (option to be approved in advance by World Aquatics Sports Medicine Committee).

9.2.7.1.2 Open Water Swimming

A medical boat capable of medically stabilizing an athlete and providing emergency transport must be on the course throughout the competition with reserve available in the event of the original medical boat having to leave the competition site. In addition, a land-based ambulance must also be on site.

9.2.7.1.3 Diving / High Diving

An ambulance must be on-site throughout all training and competition periods. A reserve unit must be available in the advent of a transport by the first ambulance team. (if necessary for High Diving, a medical boat like for Open Water)

9.2.8 Venue Pharmacy Formulary

9.2.8.1 General

World Aquatics does not have specific requirements related to the medications for the Venue Medical Station and the Field of Play Treatment Area.

Systems for secure storage and medication management must be in place for the event according to the law of the host country.

A pharmacist may be appointed to set up and manage the pharmacy service provision for the event.

Controlled drugs (such as morphine for strong analgesia) may require special storage requirements and records to be kept, according to the laws of the host country.

All medications must be recorded for each individual patient.

9.2.8.2 Anti-Doping Requirements

All LOC Medical Personnel must be familiar with the substances and methods that are prohibited in sport ([WADA Prohibited List and Methods](#)).

The [WADA Therapeutic Use Exemption International Standard](#), along with World Aquatics-specific protocols for Therapeutic Use Exemption applications, should also be referenced:

All medications at the World Aquatics Events that are also on the WADA Prohibited List should be clearly marked (e.g. coloured stickers, etc.) for easy identification as a warning to prescribing clinicians for the need for a Therapeutic Use Exemption.

If a prohibited drug is required to be prescribed, both the prescribing physician and the athlete who is receiving the medication must sign the prescription form to confirm that they are both aware of the status of the substance and that the athlete consents to receiving the drug. The dispensing pharmacist should sign the prescription to verify that they have informed the physician and the athlete that the substance is prohibited. A duplicate copy should be given to the athlete in case of notification for doping control, so the athlete has a record in writing of recent medication intake and to aid in potential results management of an adverse analytical finding.

It is also recommended that all LOC Medical Personnel (including the CMO) complete the *ADEL Medical Professional's Education Program* on [WADA's ADeL](#) (anti-doping e-learning platform).

9.2.9 Hospitals and Isolation Facilities

9.2.9.1 Hospitals

Hospital allocation for the World Aquatics Events should take into consideration:

- Anticipated health concerns

- Available hospital services (e.g., major trauma/ medical preparedness as in major trauma centres)
- Proximity to venues
- Insurance/financial requirements

The designated hospital(s) shall be communicated to World Aquatics in advance.

Few months before the World Aquatics Event, the Chief Medical Officer should develop a plan for the referral and potential transport of injured and/or ill athletes. A link with a nearby medical facility / hospital capable of providing continuing emergency care, access to laboratory investigations, imaging, and specialist opinions, including dental, should be established.

9.2.9.2 Isolation facilities in case of pandemic

Experiences with the COVID-19 pandemic during World Aquatics Events demonstrate the need to anticipate an isolation facility(ies), which could include in-room services.

9.2.10 Public Health Requirements

For major events, adherence to local public health legislation and regulations is important. Contact should be made in advance to ensure appropriate planning. The key considerations for public health at World Aquatics Events are to:

- Reduce and manage the risk of individuals acquiring an infectious illness
- Encourage health-promoting behaviours in athletes, officials and visitors
- Food and water safety

9.2.10.1 Prevention of infectious diseases

The recent years have shown that organising mass gathering events could represent a public health challenge.

The LOC Medical Team shall consider about management policy about infectious/communicable disease. This may include:

- Required immunisations for visiting athletes and World Aquatics Family and guests (e.g COVID-19, Measles, etc.)
- Geographical risks of host location (Dengue, Malaria)
- Protocols for isolation of athletes/teams with communicable diseases (COVID-19 Protocol)
- Criteria for sport participation for ill and recovering athletes
- Essential medications required for treatment of an infectious outbreak

9.2.10.2 Safe and secure food supply

The food supply channels may be at increased risk. The LOC and Public health authorities should work with local law enforcement and security agencies to ensure safety of the food supply at the venues (training/competition/staff catering) and at the accredited participants accommodation (hotels/village).

The safety includes food and water hygiene as well as protection against inadvertent ingestion of substances included on the WADA Prohibited List from contaminated foods or sports products.

9.2.11 Environmental considerations

9.2.11.1 General

The LOC Medical Team should consider the Environmental issues and evaluate them based on historical records. A risk mitigation strategy may need to be developed to address environmental risks.

Environmental risks depend on the following factors at the geographic location of the event:

- Climate: heat/cold, other extreme weather conditions
- Elevation/altitude
- Air quality
- Water quality

The other factors to be considered by LOC Medical Team and World Aquatics are the:

- Duration of the sport event
- Physiological requirements of the sport/discipline
- Time of day of the competition and training sessions
- Time of year of the event

9.2.11.2 Water Quality

Water quality is a fundamental element of our sports.

For water quality, the LOC medical team should share with World Aquatics and NFs, the records and archives from previous years.

Should there be environmental risks, consultation with sport science environmental specialists is recommended and some strategies and corrective actions be implemented.

Specific information about Water Quality may be found in the Sport Sections (II to VII).

9.2.11.2.1 Tap Water Quality

LOC shall indicate whether the tap water is drinkable without risk of infection.

9.2.11.3 Risk Mitigation Strategy

The Aquatic Sports Venues could be indoor or outdoor.

Sports like open water and high diving are outdoor and exposed to weather conditions.

Therefore, before any event, the LOC shall provide information on the actual environmental conditions and their expected evolution. It should help the NF to organise suitable travel and acclimation arrangement to their athletes.

At the competition venue:

- World Aquatics should consider the implementation of specific protocols: early departure, event cancelation, additional break for officials and athlete, appropriate clothing for officials, etc.
- LOC should aim to minimise environmental exposure by adapting scheduling, providing cooled/warmed team tent and waiting areas, etc.

- LOC should provide mitigation measures for spectators and official (educate on behavior to adopt, provide hydration and shade, distribute goodies such as paper fans and caps if necessary).

The LOC Medical Team should:

- Organise appropriate training for the medical staff in recognition and emergency treatment protocols
- Provide of specialist medical equipment such as ice baths for full body immersion
- Give access to essential medication which reflect the environmental risks
- Have clear algorithms displayed in the medical venue (e.g., exertional heat stroke algorithms)
- Planning for any specific medical equipment related to the environmental conditions (e.g. cooling bath, warm baths, rectal thermometer, sodium tester, etc.)

World Aquatics and LOC should also have a communication strategy to deal with the environmental factors that may impact the organisation of a competition (race, match).

9.2.12 Safety and security

It is important for the LOC medical team to have strategised with local safety and security departments for the event, safety and security as well as for disaster planning.

Details to be addressed include:

Liaison with:

- Police services in case of emergency to provide additional security
- Fire department services in case of fire emergency
- Emergency transportation services
- Tertiary care health services
- Supply source of essential medications
- Blood banks
- Emergency mental health services for psychological support as required.
- Public health services

Policies and procedures for major incidences/disasters:

- Terrorist attacks
- Environmental disasters such as earthquakes, tsunamis, fire, weathers, etc.
- Venues malfunction

9.2.13 Nutrition Requirements

World Aquatics and LOC medical teams should ensure adequate and appropriate nutrition at international sporting events. Nutritional requirements should include:

At the training and competition venues, provision of:

- Water and carbohydrate electrolyte replacement ('sports drink') as applicable
- A variety of food options to aid athlete recovery

At athlete lodging, delivery of a catering plan that achieves:

- Sufficient menu variety within and between meals to manage food boredom and to provide ample choices for the needs of the athletes
- Attention to the food culture of the athletic population including special cultural practices (e.g., halal, kosher)
- Food/menu options that meet the health and specific sports nutrition considerations of the athletic population (e.g., carbohydrate loading)
- Support for special dietary needs (e.g., food intolerances and allergies) or choices (e.g., vegan/vegetarian) of the athletes
- Point of choice labelling of menu items to identify nutritional characteristics and other key information (e.g., presence or absence of allergens)
- (Ideally) provision of additional education resources around sports nutrition guidelines
- Sufficient accessibility to support the overall nutritional needs of the athletes and the logistics around training and competition schedules, including flexibility to meet special needs

Ideally, information about the catering plan should be provided ahead of the World Aquatics Event for distribution to the NFs to assist in their preparations and specific plans. Such information should include:

- Specific information on key issues that might arise around the specific competition or location (e.g., food and water hygiene, control of potential contamination of food supplies)

- Specific details of how special nutritional or cultural needs will be met, including key contacts to discuss/arrange additional needs
- Specific information regarding the importing of additional food supplies to the location (e.g., local custom or quarantine regulations) to assist teams or individuals with plans to supplement the catering plan
- Protocols and procedures for the management of any declared outbreak of food-related illness

9.2.13.1 Hotel Requirements and Flexible Serving Times

Meal times must be flexible. For instance, the hotel must be able to serve breakfast before early morning practices and dinner after late evening competitions.

9.2.14 Athlete Safeguarding (Harassment and Abuse) Requirements

9.2.14.1 Policies and Procedures

The World Aquatics Athlete Safeguarding Policy can be found on Aquatics Integrity Unit' website:

<https://aquaticsintegrity.com/>

Any issue shall be reported to the Aquatic Integrity Unit.

9.2.15 Athlete Mental Health Support

Evidence shows that athletes at the elite level have a higher prevalence of mental health symptoms and disorders than non-athletes.

As such, World Aquatics aims to ensure the provision of adequate and effective mental health support for athletes at World Aquatics Events.

Hence, the following considerations to address athlete mental health issues should be assessed by World Aquatics and/or LOC:

- Opportune timing of competition events
- Appropriate timing of training/competitions sessions to allow adequate recovery and sleep
- Provision of time for recovery post training and competition

- Efficient transport system and close distance between venue and accommodation
- Allocation of quiet spaces of low stimulation
- If possible, inclusion of a licensed/registered mental health professional with experience in elite sport on the LOC medical team
- Availability of a referral network of licensed/ registered mental health professionals.

9.2.16 Host Country Government Regulations

Host countries may have specific requirements relevant to the provision of athlete health care delivery that need to be considered in the planning and delivery of the health care program at World Aquatics Events. These regulations fall under three categories:

- Medical licensing of visiting medical physicians
- Drug and medical equipment importation
- Mass event policies and procedures

9.2.16.1 Medical Licensing

The LOC shall outline the legal requirements for medical licensing of foreign physicians in the country of the event as required. Links to regulations on official government websites should be provided.

9.2.16.2 Drug and Medical Equipment Importation

The LOC medical team shall publish the national legal requirements for drug and medical equipment importation in sufficient time in advance of the World Aquatics Events for the visiting NF medical personnel. Such guidance should cover the following scenarios:

- Importation of medication supplies by team physicians for team use
- Importation of personal medication by individual athletes
- Importation of controlled drugs
- Importation of medical equipment

- Provision of medical care offered to an athlete (e.g., use of opiates in a pre-hospital environment).

9.2.17 After-hours Medical Care

After-hours emergency medical care for the athletes, visiting team officials, judges, referees and the World Aquatics Family should be arranged with easy access through the official Event hotels. This includes:

- After hours (out of venue) urgent care
- Medical services at hotels
- Athlete village health services (if applicable)

Processes and contact details should be provided with the Team Leader information packs.

9.2.17.1 Language Services

The LOC should provide adequate and timely language services to facilitate the delivery of medical care at the training and competition venues. This should include:

- Contact information for access to the event language translation services
- Designation of medical translation services (if applicable)
- Languages included
- A statement about medical information confidentiality when using language services

9.2.17.2 Glasses/Lenses Services

This is not a World Aquatics' requirement, but the experience shows that during our Events it may happen that some participants lose or break their glasses or lenses. When you have 5'000 accredited participants, it becomes a significant number of persons.

It would be appreciated if the LOC could find few reliable partners/shops that will be able to respond to any urgent situation and to replace within few hours to few days the glasses or lenses.

Such a service will be at the participant's costs.

9.2.18 Insurance & Liability

9.2.18.1 Insurance

Each accredited participant shall have their own personal medical insurance.

Athletes, Officials and World Aquatics Family members are covered by World Aquatics Insurance which can be utilised to support healthcare provision as required. However, as World Aquatics Insurance does not cover all the situations, a personal insurance is necessary.

The LOC has the responsibility to provide at minimum the first aid medical care during training and competitions. The World Aquatics Insurance may take the relay as soon as a participant is transferred to an hospital.

9.2.18.2 Medical Personnel Malpractice Insurance & Liability

World Aquatics and LOC assume no responsibility for any healthcare provided by NF healthcare personnel to NF team members and delegates.

The LOC should ensure that all members of the Medical Team are covered by professional liability insurance. The amount of coverage must be commensurate with the risks associated in providing the Medical Programme as described herein.

It is recommended that NF healthcare professionals inform their insurance company that they are travelling abroad with a sports team, and check whether their professional liability insurance covers this activity. Each NF should make its own arrangements for professional liability insurance.

9.2.19 Non-smoking Policy

The entire Venue is strictly non-smoking.

Appropriate signage shall be in place around the venues.

9.2.20 Medical Communication Strategy

World Aquatics Communication Policies regarding communication about health-related information should be reviewed in cooperation with the LOC and the LOC Medical Team.

Any question from Media related to medical issues shall be addressed to World Aquatics Communication Department. The Medical Team shall not communicate directly with Media.

9.2.21 Media, Marketing Partners, Workforce & Spectators Medical Services

The LOC shall make provisions for the health care of spectators, media, marketing partners, and workforce that are distinct from athlete health care.

The spectators, media, marketing partners, and workforce should include:

1. Designation of Health Care Personnel that are completely different from the athlete medical personnel
2. Allocation of a venue medical station for spectators, media, marketing partners, and workforce
3. Delineation of a medical action plan outlining:
 - Location of automatic external defibrillators
 - Removal from spectator area
 - Triage procedures
 - Medical protocols for trauma and illness
 - Transfer procedures from spectator venue medical station to ambulance
 - Ambulance designation
 - Hospital designation
 - Spectator medical briefing
 - Scenario training
4. Communication network
5. Medical record system
6. Public health requirements:
 - Environmental planning and protocols
 - Major incident planning and training
7. Provision of medical care for VIPs (if applicable)

9.2.22 Medical Ethical Guidelines

Athletes have the right to high-quality, ethical medical care. In elite sporting events, there may be external pressures or influences on athlete health care and return to sport from media, agents, coaches,

NF presidents etc. who wish to sway an athlete's decision to participate.

As such, it is important to emphasise the principles of ethical, athlete-centred health care delivery to all members of the LOC's medical team at World Aquatics Events.

This includes the athlete's right to:

- Confidentiality of health information
- Informed consent
- A second medical opinion
- The latest evidence-based medical care
- Safe and ethical medical practices

10. FACILITIES

10.1 General

The present Section related to Facilities is intended to provide the best possible environment for competitive use and training. This section does not intend to govern issues related to the general public. It is the responsibility of the owner or controller of a facility to provide supervision for activities undertaken by the general public.

10.2 Pools

10.2.1 World Aquatics Olympic Standard Pools

All World Championships (except the Masters World Championships) and Olympic Games must be held in pools that comply with the Facility Rules of each Sport (see Sections II to VIII).

10.2.2 World Aquatics General Standard Pools

Other World Aquatics events should be held in World Aquatics Olympic Standard Pools, but the Bureau may waive certain standards for existing pools if they do not materially interfere with the competitions.

10.2.3 World Aquatics Minimum Standard Pools

All other events held under World Aquatics Rules should be conducted in pools that comply with all of the minimum standards contained within this section.

10.3 Automatic Officiating Equipment

At Olympic Games and World Aquatics Championships, the approved Automatic Officiating Equipment, including Video Judging Equipment shall be provided and used. The approved Video Judging Equipment shall be used to initiate stroke infraction calls, confirm stroke infraction calls or assist the Referee to overturn calls made on the pool deck.

10.4 Availability of Venues

For the World Aquatics Championships all venues shall be available for use at least five (5) days before the opening ceremony.

For all other World Aquatics events all pools shall be available for use by entered competitors before the competition begins. Swimming, Open Water Swimming, Water Polo, Artistic Swimming - five (5) days prior, Diving, High Diving - eight (8) days prior.

10.4.1 Training

During the competition days, the pools shall be available for training when competitions are not in progress.

10.5 Seating

Seating positions along the side of the pool shall be provided for all competitors, team officials and unassigned technical officials, from which they may properly observe training and competitions.

10.6 New competition equipment (e.g. Starting blocks, lane-ropes, etc.) must be available by 1st January in the year of the Olympic Games and World Aquatics Championships.

10.7 At the Olympic Games, World Aquatics Championships, World Aquatics Swimming Championships (25m) and World Aquatics Junior Swimming Championships, it shall be the responsibility of the Chairperson of the World Aquatics Technical Swimming Committee (or his/her designee) to determine if a Competitor may receive an additional opportunity to compete in the situation when there is a mechanical or technical malfunction that affects the Competitor.

Example: if the lane-line on either side of a competitor snaps during the first 20m of a 100m race, the Technical Swimming Committee Chairperson may grant the allowance to re-swim the race.

At all other competitions, in the event of an equipment malfunction during a swimming race, the Referee may offer all competitors affected by such malfunction the opportunity to compete again.

- 10.8** In order to protect the health and safety of persons using swimming facilities for the purposes of recreation, training and competition, owners of public pools or pools restricted only to training and competition must comply with the requirements established by law and the health authorities in the country where the pool is situated.

11. TECHNICAL OFFICIALS

11.1 General

The Judges nominated must be of the same nationality as the World Aquatics Member proposing them and fully certified by the respective Technical Committee. A naturalised Judge would be eligible to represent the World Aquatics Member that proposed him/her, if he/she will have lived in the territory of that Member for at least one year prior to that competition. A three- year transition period is required between the international representation of two different Members.

The World Aquatics Technical Committees will propose Technical Officials (Judges and Referees) to act at the Olympic Games or World Championships from the current World Aquatics Officials Lists in the respective discipline, for approval by the World Aquatics Bureau or World Aquatics Executive.

For no show of nominated Officials, the respective Federation will be fined 2'000 Swiss Francs.

11.2 Age

The maximum age of Technical Officials (Judges, Starters and Referees) when officiating at World Aquatics Championships or World Aquatics Competitions, except Masters and Water Polo, shall be sixty-five (65) years when application is made for the respective World Aquatics List.

For Water Polo, the age limit shall be sixty (60) years during the year of competition.

11.3 Technical Lists

Technical Officials must be on current World Aquatics Lists approved by the respective Technical Committee for the Aquatics discipline in order to officiate at Olympic Games, World Aquatics Championships or World Aquatics Competitions. Nominated officials must be members of the nominating Federation and certified by the Member Federation in submitting their nomination.

12. SCORES, MEDALS AND TROPHIES

12.1 Scores and awards at the World Aquatics Championships & World Aquatics World Swimming Championships (25m)

In all World Aquatics Championships, points and awards are distributed as follows:

12.1.1 Swimming

12.1.1.1 Medals

Gold, Silver, and Bronze medals shall be awarded to the first three places in individual and relay final competitions. In swimming relays when preliminaries are swum, medals shall be awarded to those swimmers who have participated in the heats and/or the final.

In Swimming, in case of equal times, medals shall be awarded as follows: 1st place: 2 Gold – no Silver, 1 Bronze

2nd place: 1 Gold, 2 Silver – no Bronze 3rd place: 1 Gold, 1 Silver, 2 Bronze

In case of 3 equal times medals shall be awarded as follows:

1st place: 3 Gold – no Silver, no Bronze

2nd place: 1 Gold, 3 Silver – no Bronze

3rd place: 1 Gold, 1 Silver, 3 Bronze

12.1.1.2 Diplomas

Using 8 lanes in Swimming, diplomas shall be awarded to all eight finalists in individual events and to the top eight finalists in relay competitions.

In swimming relays when preliminaries are swum, diplomas shall be awarded to those swimmers who have participated in the heats and/or the final.

12.1.1.3 Trophies**12.1.1.3.1 Team Trophy**

World Aquatics Team Trophy for the top scoring team based on the following points:

10 Individual using 8 lanes:

Places 1 – 16:

18, 16, 15, 14, 13, 12, 11, 10, 8, 7, 6, 5, 4, 3, 2, 1 points

11 Relays using 8 lanes:

Places 1 – 8: 36, 32, 30, 28, 26, 24, 22, 20 points.

12.1.1.3.2 Individual Trophies

World Aquatics Individual Trophies for the top scoring male and female based upon the following points:

First Place 5 points

Second Place 3 points

Third Place 2 points

Fourth Place 1 point

Individual World Record 2 points for each record broken

If there is a tie, the World Aquatics Points Table shall be used, and a decision made by the World Aquatics.

12.1.2 Open Water Swimming**12.1.2.1 Medals**

Gold, Silver, and Bronze medals shall be awarded to the first three places in each individual and team events.

In Open Water Swimming, in case of equal places, medals shall be awarded as follows:

1st place: 2 Gold – no Silver, 1 Bronze

2nd place: 1 Gold, 2 Silver – no Bronze

3rd place: 1 Gold, 1 Silver, 2 Bronze

In case of 3 equal places medals shall be awarded as follows:

1st place: 3 Gold – no Silver, no Bronze

2nd place: 1 Gold, 3 Silver – no Bronze

3rd place: 1 Gold, 1 Silver, 3 Bronze

12.1.2.2 Diplomas

Diplomas shall be awarded to all eight finalists in each individual events and to the first eight finalists in team events.

12.1.2.3 Trophy

A special Team Trophy shall be given based upon the following points added from the two individual events (5 and 10 km) and mixed team events.

18 (1st place), 16, 14, 12, 10, 8, 6, 5, 4, 3, 2, 1 points

12.1.3 Diving

12.1.3.1 Medals

Gold, Silver, and Bronze medals shall be awarded to the first three places in individual, synchronised and team events.

12.1.3.2 Diplomas

Diplomas shall be awarded to all eight finalists in each individual events and to the first six finalists in each synchronised and team events.

12.1.3.3 Trophies

A Team Trophy shall be given to the top scoring team based on the following points:

Individual diving events:

18-16-14-12-10-8-6-5-4-3-2-1 points

Synchronised diving events (12 finalists):

27-24-21-18-15-12-9-7,5-6-4,5-3-1,5 points.

Team Event

27-24-21-18-15-12-9-7,5-6-4,5-3-1,5 points

12.1.4 High Diving**12.1.4.1 Medals**

Gold, Silver, and Bronze medals shall be awarded to the first three ranked Competitors in each event.

12.1.4.2 Diplomas

Diplomas shall be awarded to first eight finalists in each event.

12.1.5 Water Polo**12.1.5.1 Medals**

Gold, Silver, and Bronze medals shall be awarded to all the players of the first three teams.

12.1.5.2 Diplomas

Diplomas shall be awarded to all the players of the first six teams.

12.1.5.3 Trophies

A trophy shall be given to the best scorer (men and women) and goalkeeper (men and women) of the championships.

12.1.6 Artistic Swimming**12.1.6.1 Medals**

Gold, Silver, and Bronze medals shall be awarded to first three Competitors or teams in each individual, solo, duet, mixed duet and team events.

12.1.6.2 Diplomas

Diplomas shall be awarded to the first eight finalists in solo and duet events and to the first six finalists in team and free combination events.

12.1.6.3 Trophy

A Team Trophy shall be given to the best team of the championships based on the following points:

Solo, Technical Routine:

12, 11, 10, 9, 8, 7, 6, 5, 4, 3, 2, 1 points

Solo, Free Routine:

12, 11, 10, 9, 8, 7, 6, 5, 4, 3, 2, 1 points

Duet, Technical Routine:

18, 17, 16, 15, 14, 13, 12, 11, 10, 9, 8, 7 points

Duet, Free Routine:

18, 17, 16, 15, 14, 13, 12, 11, 10, 9, 8, 7 points

Mixed Duet Technical Routine

18, 17, 16, 15, 14, 13, 12, 11, 10, 9, 8, 7 points

Mixed Duet Free Routine

18, 17, 16, 15, 14, 13, 12, 11, 10, 9, 8, 7 points

Team Technical Routine:

24, 22, 20, 18, 16, 14, 12, 10, 8, 6, 4, 2 points

Team Free Routine:

24, 22, 20, 18, 16, 14, 12, 10, 8, 6, 4, 2 points

Free Combination:

24, 22, 20, 18, 16, 14, 12, 10, 8, 6, 4, 2 points

Acrobatic Routine:

24, 22, 20, 18, 16, 14, 12, 10, 8, 6, 4, 2 points

12.1.7 In case of a tie, the highest points shall be awarded to each competitor or relay team.

12.1.8 Commemorative Medals:

Commemorative medals may be given to all those connected officially with the World Aquatics Championships.

12.2 World Aquatics Junior Swimming Championships

Points and awards at the World Aquatics Junior Swimming Championships shall be distributed as per 12.1.1.

12.3 World Aquatics Junior Open Water Swimming Championships

12.3.1 Awards

12.3.1.1 Medals

Gold, Silver, and Bronze medals shall be awarded to the first three places in each individual and team events. Where equal places occur the award of medals shall be as described in 12.1.2.1

12.3.1.2 Trophy

A special Team Trophy shall be given based upon the following points added from the three individual events (5, 7.5 and 10km) and mixed team events.

18 (1st place), 16, 14, 12, 10, 8, 6, 5, 4, 3, 2, 1 points

12.4 World Aquatics Junior Artistic Swimming Championships

The Junior Worlds over all Championship Title will be awarded to the Member Federation with the over- all highest raw score determined by combining results for all events.

13. PROTESTS AND APPEALS

13.1 Protests

13.1.1 Protests are possible

- (a) if the rules and regulations for the conduct of the competition are not observed,
- (b) if other conditions endanger the competitions and/or competitors, or
- (c) against decisions of the referee; however, no protest shall be allowed against decisions of fact.

13.1.2 Protest must be submitted

- (a) to the referee,
- (b) in writing on World Aquatics Forms,
- (c) by the responsible team leader,
- (d) together with a deposit of 500 Swiss Francs or its equivalent, and
- (e) within 30 minutes following the conclusion of the respective event or match.

If conditions causing a potential protest are noted prior to the event a protest must be lodged before the signal to start is given.

13.1.3 All protests shall be considered by the referee. If the referee rejects the protest, the referee must state the reasons for her/his decision. The team leader may appeal the rejection to the Jury of Appeal whose decision shall be final. In Olympic Games and World Aquatics Championships, the Commission in each discipline shall consider the protest and give recommendations to the Jury of Appeal.

13.1.4 If the protest is rejected, the deposit will be forfeited to the management body of the competition. If the protest is upheld, the deposit will be returned.

13.1.5 In Diving, an oral complaint may be made by the competitor or a responsible team official immediately after the execution of a dive, a round of dives, or a section of the contest. If the complaint is not accepted, a formal protest may be made as in the above 1.13.1.2.

13.2 Jury of Appeal

13.2.1 For Olympic Games and World Aquatics Championships, the Jury of Appeal shall be composed of the Bureau Members and Honorary Members present with the President or in his absence a Vice President, as Chairman. For all other World Aquatics competitions, the Jury of Appeal shall be the World Aquatics delegate together with any Bureau Members or members of the appropriate Technical Committee present, with the delegate as chairman. Each member shall have one vote, except as provided hereunder, and in case of equality of voting, the Chairman has a casting vote.

13.2.2 A jury member is allowed to speak, but not to vote, on a case in which the interest of her/his own Federation is involved. A jury member having acted as an official is not allowed to vote on a case if there is a protest against her/his decision or on her/his interpretation of a Rule. In case of urgency, the jury may vote on a matter even if it has not been possible to call all the members. The decision of the jury is final.

PART TWO: SWIMMING RULES

1. MANAGEMENT OF COMPETITIONS

1.1 The Management Committee appointed by the governing body shall have jurisdiction over all matters not assigned by the rules to the referee, judges or other officials and shall have power to postpone events and give directions consistent with rules adopted for conducting any event.

1.2 Organisers of swimming competitions shall appoint sufficient officials to ensure the fairness, integrity and safety of the competition.

1.2.1 At the Olympic Games, the World Aquatics Championships, and the World Aquatics Swimming Championships (25m), the following minimum number of officials for the control of the competition shall be appointed:

- Referee (2)
- Starters (2)
- Judges of Stroke (4)
- Chief Inspector of Turns (2)
- Inspectors of Turns (16/20 + 2 reserves)
- Control Room Supervisor (1)
- Video Review Supervisor (1)
- Video Review judges (4/5)
- Call Room Supervisor (1)
- Call room judges (4/5)
- Resolution Desk judge
- Warm-up supervisor(s)

1.2.2 For all other international competitions, the governing body shall appoint the same or fewer number of officials, subject to the approval of the respective regional or international authority where appropriate.

1.2.3 Where Automatic Officiating Equipment is not available, such equipment must be replaced by a chief timekeeper. Wherever

possible, a minimum of one (1) timekeeper per lane shall be appointed together with one (1) additional timekeeper in case of a watch malfunction. It is advisable that there shall be three (3) timekeepers for each lane.

1.2.4 Finish judges may be used when Automatic Equipment and/or watches are not used.

1.3 The swimming pool and the technical equipment for Olympic Games and World Aquatics Championships shall be inspected and approved prior to the Swimming competitions by the World Aquatics Delegate together with a member of the Technical Swimming Committee.

1.4 Where underwater video equipment is used by television, the equipment must be operated by remote control and shall not obstruct the vision or path of swimmers and must not change the configuration of the pool or obscure the required World Aquatics markings.

1.5 The event management shall specify for heats, semi-finals, and finals the presentation and preparation protocol that the competitors must respect when they leave the final call-room.

1.6. Program of World Aquatics and Olympic Games Swimming Competitions

1.6.1 Program of the Olympic Games

| | <u>Men</u> | <u>Women</u> |
|-------------------|-----------------|-----------------|
| Freestyle | 50m, 100m, 200m | 50m, 100m, 200m |
| | 400m, 800m | 400m, 800m |
| | 1500m | 1500m |
| Backstroke | 100m, 200m | 100m, 200m |
| Breaststroke | 100m, 200m | 100m, 200m |
| Butterfly | 100m, 200m | 100m, 200m |
| Individual Medley | 200m, 400m | 200m, 400m |
| Relays: Freestyle | 4x100m, 4x200m | 4x100m, 4x200m |

| | | |
|----------------|---------------|--------|
| Relays: Medley | 4x100m | 4x100m |
| Mixed Relays | 4x100m Medley | |

Only entry times achieved in 50m pools will be accepted. Heats and semi-finals may be swum using 10 lanes. Finals should be swum using 8 lanes.

1.6.2 Program of the World Aquatics Championships (50m)

| | <u>Men</u> | <u>Women</u> |
|-------------------|------------------------------------|-----------------|
| Freestyle | 50m, 100m, 200m | 50m, 100m, 200m |
| | 400m, 800m | 400m, 800m |
| | 1500m | 1500m |
| Backstroke | 50m, 100m, 200m | 50m, 100m, 200m |
| Breaststroke | 50m, 100m, 200m | 50m, 100m, 200m |
| Butterfly | 50m, 100m, 200m | 50m, 100m, 200m |
| Individual Medley | 200m, 400m | 200m, 400m |
| Relays: Freestyle | 4x100m, 4x200m | 4x100m, 4x200m |
| Relays: Medley | 4x100m | 4x100m |
| Mixed Relays | 4x100m Freestyle and 4x100m Medley | |

Only entry times achieved in 50m pools will be accepted. Heats and semi-finals may be swum using 10 lanes. Finals should be swum using 8 lanes.

1.6.3 Program of World Aquatics Swimming Championships (25m)

| | <u>Men</u> | <u>Women</u> |
|--------------|-------------------|----------------------|
| Freestyle | 50m, 100m, 200m | 50m, 100m, 200m |
| | 400m, 800m, 1500m | 400m, 800m, 1500m |
| Backstroke | 50m, 100m, 200m | 50m, 100m, 200m |
| Breaststroke | 50m, 100m, 200m | 50m, 100m, 200m |

| | | |
|-------------------|----------------------------------|-------------------------|
| Butterfly | 50m, 100m, 200m | 50m, 100m, 200m |
| Individual Medley | 100m, 200m, 400m | 100m, 200m, 400m |
| Relays: Freestyle | 4x50m, 4x100m 4x200m | 4x50m, 4x100m 4x200m |
| Relays: Medley | 4x50m, 4x100m | 4x50m, 4x100m |
| Mixed Relays | 4x50m Freestyle and 4x50m Medley | |

Entry times achieved in 25m and 50m pools will be accepted. Heats and semi-finals may be swum using 10 lanes. Finals should be swum using 8 lanes.

1.6.4 Program of the World Aquatics Junior Swimming Championships

| | <u>Men</u> | <u>Women</u> |
|-------------------|--|--|
| Freestyle | 50m, 100m, 200m 400m, 800m 1500m | 50m, 100m, 200m 400m, 800m 1500m |
| Backstroke | 50m, 100m, 200m | 50m, 100m, 200m |
| Breaststroke | 50m, 100m, 200m | 50m, 100m, 200m |
| Butterfly | 50m, 100m, 200m | 50m, 100m, 200m |
| Individual Medley | 200m, 400m | 200m, 400m |
| Relays: Freestyle | 4x100m, 4x200m | 4x100m, 4x200m |
| Relays: Medley | 4x100m | 4x100m |
| Mixed Relays | 4x100m Freestyle and 4x100m Medley | |

Only entry times achieved in 50m pools will be accepted. Heats and semi-finals may be swum using 10 lanes. Finals should be swum using 8 lanes.

1.6.5 Program of the World Aquatics Swimming World Cup

The program of the World Aquatics Swimming World Cup will be defined by

World Aquatics on an annual basis.

2. OFFICIALS

2.1 Referee

2.1.1 The referee shall have full control and authority over all officials, approve their assignments, and instruct them regarding all special features or regulations related to the competitions. She/He shall enforce all rules and decisions of World Aquatics and shall decide all questions relating to the actual conduct of the meet, and event or the competition, the final settlement of which is not otherwise covered by the rules.

2.1.2 The referee may intervene in the competition at any stage to ensure that the World Aquatics regulations are observed, and shall adjudicate all protests related to the competition in progress.

2.1.3 When using finish judges without three (3) digital watches, the referee shall determine placing where necessary. Automatic Officiating Equipment, if available and operating shall be consulted as stated in II.13.

2.1.4 The referee shall ensure that all necessary officials are in their respective posts for the conduct of the competition. He/She may appoint substitutes for any who are absent, incapable of acting or found to be inefficient. He/She may appoint additional officials if considered necessary.

2.1.5 Once all swimmers have removed their clothing, except for swimwear, the Referee shall signal the commencement of an event by a short series of whistles inviting them to get ready at the starting end, followed by a long whistle indicating that they should take their positions on the starting platform (or for backstroke swimming and medley relays to immediately enter the water). A second long whistle shall bring the backstroke and medley relay swimmer immediately to the starting position. When the swimmers and officials are prepared for the start, the referee shall gesture to the starter with a stretched-out arm, indicating that the swimmers are under the starter's control. The stretched-out arm shall stay in that position until the start is given.

2.1.6 A disqualification for initiating the start before the starting signal must be observed and confirmed by both the Starter and the

Referee. When Automatic Officiating Equipment is available, it may be used to verify the disqualification.

2.1.7 The referee shall disqualify any swimmer for any other violation of the rules that they personally observe. The referee may also disqualify any swimmer for any violation reported to him by other authorised officials. All disqualifications are subject to the decision of the referee.

2.1.8 All potential infractions shall be verbally reported to the Referee. Once confirmed by the Referee, a signed disqualification card shall be completed by the reporting official, detailing the event, lane number and the infraction.

2.1.9 The Referee shall appoint officials who shall determine, in relay events, whether the starting swimmer is in contact with the starting platform when the preceding swimmer touches the starting wall. When Automatic Officiating Equipment which judges relay take-offs is available, it shall be used in accordance with II.13.1.

2.2 Control Room Supervisor

2.2.1 The Control Room Supervisor shall supervise the operation of the Automatic Officiating Equipment.

2.2.2 The Control Room Supervisor is responsible for checking the results from computer printouts.

2.2.3 The Control Room Supervisor is responsible for checking the relay exchange printout and reporting any early take-offs to the referee.

2.2.4 The Control Room Supervisor may review the video timing to confirm early take-off.

2.2.5 The Control Room Supervisor shall

- control withdrawals after the heats and/or semi- finals,
- enter results on official forms,
- list all new records established, and
- maintain scores where appropriate.

2.3 Starter

2.3.1 The starter shall have full control of the swimmers from the time the referee turns the swimmers over to him (II.2.1.5) until the race has commenced. The start shall be given in accordance with II.4.

2.3.2 The starter shall report a swimmer to the referee for delaying the start, for willfully disobeying an order or for any other misconduct taking place at the start, but only the referee may disqualify a swimmer for such delay, willful disobedience or misconduct.

2.3.3 The starter shall have power to decide whether the start is fair, subject only to the decision of the Referee.

2.3.4 When starting an event, the starter shall stand on the side of the pool within approximately five metres of the starting edge of the pool where the timekeepers can see and or hear the starting signal and the swimmers can hear the signal.

2.3.5 The Starter shall report to the Referee any violation observed within their jurisdiction.

2.4 Call Room Supervisor

2.4.1 The Call Room Supervisor shall assemble swimmers prior to each event.

2.4.2 The Call Room Supervisor shall report to the Referee any violation noted with regard to:

- swimwear;
- advertising (I.8 Advertising Identification); and
- if a swimmer is not present when called.

2.5 Chief Inspector of Turns

2.5.1 The Chief Inspector of Turns shall ensure that inspectors of turns fulfil their duties during the competition.

2.6 Inspectors of Turns

2.6.1 One Inspector of Turns shall be assigned to each lane at each end of the pool, to ensure swimmers comply with the relevant rules after the start, for each turn, and at the finish.

2.6.2 Jurisdiction for the Inspector of Turns at the start end commences from the start signal until the completion of the first arm

stroke, except in Breaststroke where it shall be the second arm stroke.

2.6.3 For each turn, jurisdiction for the Inspector of Turns commences from the beginning of the last arm stroke before touching and ending with the completion of the first arm stroke after the turn, except in Breaststroke where it shall be the second arm stroke.

2.6.4 Jurisdiction for the Inspector of Turns at the finish commences from the beginning of the last arm stroke before touching.

2.6.5 When a Backstroke ledge is being used, each inspector at the starting end shall install and remove the ledge. Once installed, the ledge shall be set at zero (0).

2.6.6 In individual events of 800 and 1500 metres, each Inspector of Turns at the start and turning end of the pool shall record the number of laps completed by the swimmer in his/her lane. The swimmers shall be informed of the remaining number of laps to be completed by displaying “lap cards” showing odd numbers at the turning end of the pool. Electronic equipment may be used, including under water display.

2.6.7 Each inspector at the starting end shall give a warning signal when the swimmer in their lane has two lengths plus five (5) metres to swim to finish in individual events of 800 and 1500 metres. The signal may be repeated after the turn until the swimmer has reached the five (5) metres mark on the lane rope. The warning signal may be by whistle or bell.

2.6.8 Each inspector at the starting end shall determine, in relay events, whether the starting swimmer is in contact with the starting platform when the preceding swimmer touches the starting wall. When Automatic Equipment which judges relay take-offs is available, it shall be used in accordance with II.13.1.

2.6.9 Inspectors of Turns shall report to the Referee any violation observed within their jurisdiction.

2.7 Judges of Stroke

2.7.1 Judges of Stroke shall be located on each side of the pool.

2.7.2 Each Judge of Stroke shall ensure that the rules related to the

style of swimming designated for the event are being observed and shall observe the turns and the finishes to assist the Inspectors of Turns.

2.7.3 Judges of Stroke shall report to the Referee any violation observed within their jurisdiction.

2.8 Chief Timekeeper

2.8.1 The Chief Timekeeper shall assign the seating positions for all timekeepers and the lanes for which they are responsible. It is advisable that there shall be three (3) timekeepers for each lane. If Automatic Officiating Equipment is not used there shall be two (2) additional timekeepers designated, either of whom shall be directed to replace a timekeeper whose watch did not start or stopped during an event, or who for any other reason is not able to record the time. When using digital watches, final time and place is determined by time.

2.8.2 When only one (1) timekeeper per lane is available, an extra timekeeper must be assigned in case of a malfunction of a watch. In addition, the chief timekeeper must always record the time of the winner of each race.

2.8.3 The Chief Timekeeper shall collect from the timekeepers in each lane a card showing the times recorded and, if necessary, inspect their watches.

2.8.4 The Chief Timekeeper shall record or examine the official time on the card for each lane.

2.9 Timekeepers

2.9.1 Each timekeeper shall take the time of the swimmers in the lane assigned to him in accordance with II.11.3.

2.9.2 Each timekeeper shall start their watch at the starting signal and shall stop it when the swimmer in their lane has completed the race. Timekeepers may be instructed by the Chief Timekeeper to record times at intermediate distances in races longer than 100 metres.

2.9.3 Promptly after the race, the timekeepers in each lane shall record the times of their watches on the card, give them to the Chief Timekeeper, and if requested present their watches for inspection.

Their watches must be cleared at the short whistle of the Referee announcing the following race.

2.9.4 Unless video timing is used, it may be necessary to use the full complement of timekeepers even when Automatic Officiating Equipment is used.

2.10 Finish Judges – if required

2.10.1 Finish judges shall be positioned in line with the finish where they have at all times a clear view of the course and the finish line.

2.10.2 After each event the finish judges shall decide and report the placing of the swimmers according to the assignments given to them. Finish judges other than push- button operators shall not act as timekeepers in the same event.

2.11 Chief Recorder (other than for Olympic Games and World Aquatics Championships)

2.11.1 The chief recorder is responsible for checking results from computer printouts or from results of times and placing in each event received from the referee. The chief recorder shall witness the referee's signing the results.

2.12 Recorder (other than for Olympic Games and World Aquatics Championships)

2.12.1 The recorders shall control withdrawals after the heats or semi-finals, enter results on official forms, list all new records established, and maintain scores where appropriate.

2.13 Video Review Supervisor

2.13.1 The Video Review Supervisor shall ensure that Video Review Judges are in their respective posts and fulfil their duties during the competition.

2.13.2 The Video Review Supervisor shall review and confirm all rule infractions reported to them by the Video Review Judges.

2.13.3 The Video Review Supervisor shall review and confirm all rule infractions reported to them at the request of the Referee.

2.13.4 The Video Review Supervisor shall report to the Referee any violation confirmed in the video review.

2.14 Video Review Judge

2.14.1 Each Video Review Judge shall ensure that the rules related to the style of swimming designated for the event are being observed and shall observe the turns and the finishes.

2.14.2 Video Review Judge shall report any violation observed to the Video Review Supervisor. If the infraction is confirmed, the video review judge shall complete a disqualification card.

2.15 Officials' Decision Making

2.15.1 Officials shall make their decision autonomously and independently of each other unless otherwise provided in Section II.

3. SEEDING OF HEATS, SEMI-FINALS AND FINALS

The starting stations for all events in Olympic Games, World Aquatics Championships, Regional Games and other World Aquatics competitions shall be by seeding as follows:

3.1 Heats

3.1.1 The best competitive times of all entrants for the announced qualifying period prior to the entry deadline of the competition shall be submitted on entry forms or on-line, as requested, and listed in order of time by the Management Committee. Swimmers who do not submit official recorded times shall be considered the slowest and shall be placed at the end of the list with a no time. Placement of swimmers with identical times or of more than one swimmer without times shall be determined by draw. Swimmers shall be placed in lanes according to the procedures set forth in II.3.1.2 below. Swimmers shall be placed in trial heats according to submitted times in the following manner.

3.1.1.1 If one heat, it shall be seeded as a final and swum only during the final session.

3.1.1.2 If two heats, the fastest swimmer shall be seeded in the second heat, next fastest in the first heat, next fastest in the second heat, next in the first heat, etc.

3.1.1.3 If three heats, except 400m, 800m and 1500m events, the fastest swimmer shall be placed in the third heat, next fastest in the second, next fastest in the first. The fourth fastest

swimmer shall be placed in the third heat, the fifth in the second heat, and the sixth fastest in the first heat, the seventh fastest in the third heat, etc.

3.1.1.4 If four or more heats, except 400m, 800m and 1500m events, the last three heats of the event shall be seeded in accordance with II.3.1.1.3 above. The heat preceding the last three heats shall consist of the next fastest swimmers; the heat preceding the last four heats shall consist of the next fastest swimmers, etc. Lanes shall be assigned in descending order of submitted times within each heat, in accordance with the pattern outlined in II.3.1.2 below.

3.1.1.5 For 400m, 800m and 1500m events, the last two heats of the event shall be seeded in accordance with II.3.1.1.2.

3.1.1.6 Exception: When there are two or more heats in an event, there shall be a minimum of three swimmers seeded into any one preliminary heat, but subsequent scratches may reduce the number of swimmers in such heat to less than three.

3.1.1.7 When a ten (10) lane pool is available and equal times are established for the 8th place in the heats of events in excess of 200m and, including relay events, lane 0 will be used. A random draw will be held to determine which competitor is allocated in lane 8 and lane 0. In case of three (3) equal times for 8th place, lane 9 and 0 will be used with a random draw for lane 8, 9 and 0. In the event that there are more than three (3) competitors or teams having equal times for 8th place in the heats or semi-finals, a swim-off may be held.

3.1.1.8 Where a 10 lane pool is not available II.3.2.3 will apply.

3.1.2 Except for 50 metre events in 50 metre pools, assignment of lanes shall be (number 1 lane being on the right side of the pool (0 when using pools with 10 lanes) when facing the course from the starting end) by placing the fastest swimmer or team in the centre lane in pool with an odd number of lanes, or in lane 3 or 4 respectively in pools having 6 or 8 lanes. In pools using 10 lanes, the fastest swimmer shall be placed in lane 4. The swimmer having the next fastest time is to be placed on their left, then alternating the others to right

and left in accordance with the submitted times. Swimmers with identical times shall be assigned their lane positions by draw within the aforesaid pattern.

3.1.3 When 50 metre events are contested in 50 metre pools, the races may be swum, at the discretion of the Management Committee, either from the regular starting end to the turning end or from the turning end to the starting end, depending upon such factors as existence of adequate Automatic Equipment, starter's position, etc. The Management Committee should advise swimmers of their determination well before the start of the competition. Regardless of which way the race is swum, the swimmers shall be seeded in the same lanes in which they would be seeded if they were both starting and finishing at the starting end.

3.2 Semi-Finals and Finals

3.2.1 In the semi-finals heats shall be assigned as in II.3.1.1.2.

3.2.2 Where no preliminary heats are necessary, lanes shall be assigned in accordance with II.3.1.2 above. Where preliminary heats or semi-finals have been held, lanes shall be assigned as in II.3.1.2 based, however, on times established in such heats.

3.2.3 In the event that swimmers from the same or different heats have equal times registered to 1/100 second for either the eighth/tenth place or sixteenth/twentieth place depending on the use of 8 or 10 lanes, there may be a swim-off to determine which swimmer shall advance to the appropriate finals. Such swim-off shall take place after all involved swimmers have completed their heats at a time agreed between the event management and the parties involved. Another swim-off may take place if equal times are registered again. If required, a swim off will take place to determine 1st and 2nd reserve if equal times are recorded.

3.2.4 Where one or more swimmers scratch from a semi-final or final reserves will be called in order of classifications in heats or semi-finals. Whenever possible, the event or events must be re-seeded and supplementary sheets must be issued detailing the changes or substitutions, as prescribed in II.3.1.2.

3.2.5 For heats, semi-finals and finals, swimmers shall report to the First Call Room at a time determined by the event management. After

inspection, swimmers proceed to the final call-room.

3.3 In other competitions, the draw system may be used for assigning lane positions.

3.4 In the World Aquatics Swimming Championships (25m) and World Aquatics Junior Swimming Championships, the 800m Freestyle and the 1500m Freestyle may at the discretion of the Bureau be conducted on a timed final basis with the fastest heat only conducted during the finals session.

In distances of 50m, 100m and 200m, heats, semi-finals and finals will be held. At the World Aquatics Swimming Championships (25m) and World Aquatics Junior Swimming Championships events of 200m and above only heats and finals will take place.

4. THE START

4.1 The start in Freestyle, Breaststroke, Butterfly and Individual Medley races shall be with a dive. On the long whistle (II.2.1.5) from the referee the swimmers shall step onto the starting platform and remain there. On the starter's command "take your marks", they shall immediately take up a starting position with at least one foot at the front of the starting platforms. The position of the hands is not relevant. When all swimmers are stationary, the Starter shall give the starting signal.

4.2 The start in Backstroke and Medley Relay races shall be from the water. At the referee's first long whistle (II.2.1.5), the swimmers shall immediately enter the water. At the referee's second long whistle the swimmers shall return without undue delay to the starting position (II.6.1). When all swimmers have assumed their starting positions, the starter shall give the command "take your marks". When all swimmers are stationary, the starter shall give the starting signal.

4.3 In Olympic Games, World Aquatics Championships and other World Aquatics events the command "Take your marks" shall be in English and the start shall be by multiple loudspeakers, mounted one at each starting platform.

4.4 Any swimmer initiating a start before the signal may be disqualified. If the starting signal sounds before the disqualification is declared, the race shall continue and the swimmer or swimmers shall be disqualified upon completion of the race. If the disqualification is declared before the starting signal, the signal shall not be given, but the remaining swimmers shall be called back and start again. The referee repeats the starting procedure beginning with the long whistle (the second one for Backstroke) as per II. 2.1.5.

5. FREESTYLE

5.1 Freestyle means that in an event so designated the swimmer may swim any style, except that in individual medley or medley relay events, freestyle means any style other than backstroke, breaststroke or butterfly.

5.2 Some part of the swimmer must touch the wall upon completion of each length and at the finish.

5.3 Some part of the swimmer must break the surface of the water throughout the race, except it shall be permissible for the swimmer to be completely submerged during the turn and for a distance of not more than 15 metres after the start and each turn. By that point, the head must have broken the surface.

6. BACKSTROKE

6.1 Prior to the starting signal, the swimmers shall line up in the water facing the starting end, with both hands holding the starting grips. Standing in or on the gutter or bending the toes over the lip of the gutter is prohibited. When using a backstroke ledge at the start, at least one toe of each foot must be in contact with the end wall or face of the touchpad. Bending the toes over the top of the touchpad is prohibited.

6.2 At the signal for starting and after turning the swimmer shall push off and swim upon their back throughout the race except when

executing a turn as set forth in II.6.4. The normal position on the back can include a roll movement of the body up to, but not including 90 degrees from horizontal. The position of the head is not relevant.

6.3 Some part of the swimmer must break the surface of the water throughout the race, except that once some part of the head of the swimmer has passed the 5 metres mark immediately prior to reaching for the finish, the swimmer may be completely submerged. It is also permissible for the swimmer to be completely submerged during the turn, and for a distance of not more than 15 metres after the start and each turn. By that point the head must have broken the surface.

6.4 When executing the turn there must be a touch of the wall with some part of the swimmer's body. During the turn the shoulders may be turned over the vertical to the breast after which an immediate continuous single arm pull or immediate continuous simultaneous double arm pull may be used to initiate the turn. The swimmer must have returned to the position on the back upon leaving the wall.

6.5 Upon the finish of the race the swimmer must touch the wall while on the back.

7. BREASTSTROKE

7.1 After the start and after each turn, the swimmer may take one arm stroke completely back to the legs during which the swimmer may be submerged. At any time prior to the first Breaststroke kick after the start and after each turn a single butterfly kick is permitted. The head must break the surface of the water before the hands turn inward at the widest part of the second stroke.

7.2 From the beginning of the first arm stroke after the start and after each turn, the body shall be on the breast. It is not permitted to roll onto the back at any time except at the turn after the touch of the wall where it is permissible to turn in any manner as long as the body is on the breast when leaving the wall. From the start and throughout the race the stroke cycle must be one arm stroke and one leg kick in that order. All movements of the arms shall be simultaneous without

alternating movement.

7.3 The hands shall be pushed forward together from the breast on, under, or over the water. The elbows shall be under water except for the final stroke before the turn, during the turn and for the final stroke at the finish. The hands shall be brought back on or under the surface of the water. The hands shall not be brought back beyond the hip line, except during the first stroke after the start and each turn.

7.4 During each complete cycle, some part of the swimmer's head must break the surface of the water. All movements of the legs shall be simultaneous without alternating movement.

7.5 The feet must be turned outwards during the propulsive part of the kick. Alternating movements or downward butterfly kicks are not permitted except as in II.7.1. Breaking the surface of the water with the feet is allowed unless followed by a downward butterfly kick.

7.6 At each turn and at the finish of the race, the touch shall be made with both hands separated and simultaneously at, above, or below the water level. At the last stroke before the turn and at the finish an arm stroke not followed by a leg kick is permitted. The head may be submerged after the last arm pull prior to the touch, provided it breaks the surface of the water at some point during the last complete or incomplete cycle preceding the touch.

8. BUTTERFLY

8.1 From the beginning of the first arm stroke after the start and each turn, the body shall be kept on the breast. It is not permitted to roll onto the back at any time, except at the turn after the touch of the wall where it is permissible to turn in any manner as long as the body is on the breast when leaving the wall.

8.2 Both arms shall be brought forward simultaneously over the water and brought backward simultaneously under the water through-out the race, subject to II. 8.5.

8.3 All up and down movements of the legs must be simultaneous. The legs or the feet need not be on the same level, but they shall not

alternate in relation to each other. A breaststroke kicking movement is not permitted.

8.4 At each turn and at the finish of the race, the touch shall be made with both hands separated and simultaneously, at, above or below the water surface.

8.5 At the start and at turns, a swimmer is permitted one or more leg kicks and one arm pull under the water, which must bring him to the surface. It shall be permissible for a swimmer to be completely submerged for a distance of not more than 15 metres after the start and after each turn. By that point, the head must have broken the surface. The swimmer must remain on the surface until the next turn or finish.

9. MEDLEY SWIMMING

9.1 In individual medley events, the swimmer covers the four swimming strokes in the following order: Butterfly, Backstroke, Breaststroke and Freestyle. Each of the strokes must cover one quarter (1/4) of the distance.

9.2 In Freestyle the swimmer must be on the breast except when executing a turn. The swimmer must return to the breast before any kick or stroke. Leaving the wall on the back during the freestyle portion is permissible but no kicking action is permitted until the swimmer has returned past the vertical to the breast at which point kicking, including a butterfly kick(s), may commence.

9.3 In Medley relay events, swimmers will cover the four swimming strokes in the following order: Backstroke, Breaststroke, Butterfly and Freestyle. Each of the strokes must cover one quarter (1/4) of the distance.

9.4 Each section must be finished in accordance with the rule which applies to the stroke concerned.

10. THE RACE

- 10.1** All individual races must be held as separate gender events.
- 10.2** A swimmer swimming over the course alone shall cover the whole distance to qualify. A swimmer who does not complete the whole distance in accordance with the relevant World Aquatics rules shall be disqualified.
- 10.3** On the pool deck, after respecting the presentation protocol outlined in II.1.5, the competitors must immediately remove all clothing except for swimwear.
- 10.4** The swimmer must remain and finish the race in the same lane in which he/she started.
- 10.5** In all events, a swimmer when turning shall make physical contact with the end of the pool or course. The turn must be made from the wall, and it is not permitted to take a stride or step from the bottom of the pool.
- 10.6** Standing on the bottom during freestyle events or during the freestyle portion of medley events shall not disqualify a swimmer, but shall not walk.
- 10.7** Pulling on the lane rope is not allowed.
- 10.8** Obstructing another swimmer by swimming across another lane or otherwise interfering shall disqualify the offender. Should the foul be intentional, the referee shall report the matter to the Member promoting the race, and to the Member of the swimmer so offending.
- 10.9** Any swimmer not entered in a race, who enters the water in which an event is being conducted before all swimmers therein have completed the race, shall be disqualified from their next scheduled race in the meet.
- 10.10** There shall be four swimmers on each relay team. Mixed relays may be swum. Mixed Relays must consist of two (2) Men and two (2) Women. Split times achieved in these events cannot be used for records and/or entry purposes.
- 10.11** Relay exchanges must commence from the starting platform. Running starts from the pool deck are not permitted.

10.12 In relay events, the team of a swimmer whose feet lose touch with the starting platform before the preceding team-mate touches the wall shall be disqualified.

10.13 Any relay team shall be disqualified from a race if a team member, other than the swimmer designated to swim that length, enters the water when the race is being conducted, before all swimmers of all teams have finished the race.

10.14 The members of a relay team and their order of competing must be nominated before the race. Any relay team member may compete in a race only once. The composition of a relay team may be changed between the heats and finals of an event, provided that it is made up from the list of swimmers properly entered by a member for that event. Failure to swim in the order listed will result in disqualification. Substitutions may be made only in the case of a documented medical emergency.

10.15 Any swimmer having finished their race, or their distance in a relay event, must leave the pool as soon as possible without obstructing any other swimmer who has not yet finished their race. Otherwise, the swimmer committing the fault, or their relay team, shall be disqualified.

10.16 Should a foul endanger the chance of success of a swimmer, the referee shall have the power to allow him to compete in the next heat or, should the foul occur in a final event or in the last heat, he/she may order it to be re-swum.

10.17 No pace-making shall be permitted, nor may any device be used or plan adopted which has that effect.

11. TIMING

11.1 The operation of Automatic Officiating Equipment shall be under the supervision of appointed officials. Times recorded by Automatic Equipment shall be used to determine the winner, all placing and the time applicable to each lane. The placing and times so determined shall have precedence over the decisions of timekeepers. In the event that a break-down of the Automatic Equipment occurs or that it is

clearly indicated that there has been a failure of the Equipment, or that a swimmer has failed to activate the Equipment, the recordings of the timekeepers shall be official (See II.13.3). In the event that there is failure of all timing devices in a lane then the swimmer may be offered a reswim.

11.2 When Automatic Officiating Equipment is used, the results shall be recorded only to 1/100 of a second. In the event of equal times, all swimmers who have recorded the same time at 1/100 of a second shall be accorded the same placing. Times displayed on the electronic scoreboard should show 1/100 of a second.

11.3 Any timing device that is terminated by an official shall be considered a watch. Such manual times must be taken by three timekeepers appointed or approved by the Member in the country concerned. All watches shall be certified as accurate to the satisfaction of the governing body concerned. Manual timing shall be registered to 1/100 of a second. Where no Automatic Equipment is used, official manual times shall be determined as follows:

11.3.1 If two (2) of the three (3) watches record the same time and the third disagrees, the two identical times shall be the official time.

11.3.2 If all three (3) watches disagree, the watch recording the intermediate time shall be the official time.

11.3.3 With only two (2) out of three (3) watches working the average time shall be the official time. When this calculation results in a value that is expressed in thousandths of a second, the final digit shall be dropped without rounding.

11.4 Should a swimmer be disqualified during or following an event, such disqualification should be recorded in the official results, but no time or place shall be recorded or announced.

11.5 In the case of a relay disqualification, legal splits up to the time of the disqualification shall be recorded in the official results.

11.6 All 50 metre and 100 metre splits shall be recorded for lead-off swimmers during relays and published in the official results.

12. WORLD RECORDS

12.1 For World Records and World Junior Records in 50 metre courses, the following distances and styles for both sexes shall be recognised:

| | |
|--------------------------------|---|
| Freestyle | 50, 100, 200, 400, 800 and 1500 metres |
| Backstroke | 50, 100 and 200 metres |
| Breaststroke | 50, 100 and 200 metres |
| Butterfly | 50, 100 and 200 metres |
| Individual Medley | 200 and 400 metres |
| Freestyle Relays | 4x100 and 4x200 metres |
| Medley Relay | 4x100 metres |
| Mixed Relays Medley | 4x100 metres Freestyle and 4 x 100 metres |

12.2 For World Records and World Junior Records in 25 metre courses, the following distances and styles for both sexes shall be recognised:

| | |
|--------------------------------|--|
| Freestyle | 50, 100, 200, 400, 800 and 1500 metres |
| Backstroke | 50, 100 and 200 metres |
| Breaststroke | 50, 100 and 200 metres |
| Butterfly | 50, 100 and 200 metres |
| Individual Medley | 100, 200 and 400 metres |
| Freestyle Relays | 4x50, 4x100 and 4x200 metres |
| Medley Relay | 4x50 and 4x100 metres |
| Mixed Relays Medley | 4x50 metres Freestyle and 4x50 metres |

12.3 The age groups for World Junior Records are the same as for the World Aquatics Junior Swimming Championships.

- 12.4** Members of relay teams must be of the same nationality.
- 12.5** All records must be made in scratch competition or an individual race against time, held in public and announced publicly by advertisement at least three days before the attempt is to be made. In the event of an individual race against time being sanctioned by a Member Federation, as a time trial during a competition, then an advertisement at least three (3) days before the attempt is to be made shall not be necessary.
- 12.6** The length of each lane of the course must be certified by a surveyor or other qualified official appointed or approved by the Member Federation in the country in which it is situated.
- 12.7** Where a moveable bulkhead is used, course measurement of the lane must be confirmed at the conclusion of the session during which the time was achieved.
- 12.8** World Records and World Junior Records will be accepted only when times are recorded by Automatic Officiating Equipment, or Semi-Automatic Officiating Equipment in the case of Automatic Officiating Equipment system malfunction.
- 12.9** World Records and World Junior Records can be established only by swimmers wearing World Aquatics approved swimwear (see II.15).
- 12.10** Times which are equal to 1/100 of a second will be recognised as equal records and swimmers achieving these equal times will be called «Joint Holders». Only the time of the winner of a race may be submitted for a World Record – except for World Juniors Records. In the event of a tie in a record-setting race, each swimmer who tied shall be considered a winner.
- 12.11** Worlds Records and World Junior Records can be established only in water with less than 3 gr/litre of salt. No World Records will be recognized in any kind of sea or ocean water.
- 12.12** The first swimmer in a relay, except in mixed relays, may apply for a World Record or a World Junior Record. Should the first swimmer in a relay team complete his/her distance in record time in accordance with the provisions of this subsection, his/her performance shall not be nullified by any subsequent disqualification of his/her relay team for violations occurring after his/her distance

has been completed.

12.13 A swimmer in an individual event may apply for a World Record or a World Junior Records at an intermediate distance if he/she or his/her coach or manager specifically requests the referee that their performance be especially timed or if the time at the intermediate distance is recorded by Automatic Officiating Equipment. Such swimmer must complete the scheduled distance of the event to apply for a record at the intermediate distance.

12.14 Applications for World Records and World Junior Records must be made on the World Aquatics official form by the responsible authority of the organizing or management committee of the competition and signed by an authorized representative of the Member Federation in the country of the swimmer, certifying that all regulations have been observed including certification of the pool measurement and that the athlete was subject to an anti-doping test immediately after the race, or at the latest, within 24 hours of the conclusion of the Event, and such test returned a negative finding. When a relay team breaks or equals a World Record / World Junior Record, only the four Athletes who swam this specific race must return a negative finding. The application form shall be forwarded to the Executive Director of World Aquatics within fourteen (14) days after the performance.

12.15 A claim of a World Record or a World Junior Record performance shall be provisionally reported by e-mail to the Executive Director of World Aquatics within seven (7) days of the performance.

12.16 The Member Federation in the country of the swimmer should report this performance by letter to the Executive Director of World Aquatics for information and action, if necessary, to assure that the official application has been properly submitted by the appropriate authority.

12.17 On receipt of the official application, and upon satisfaction that the information contained in the application, including a certification of the pool measurement and a negative doping control test certificate, is accurate, the Executive Director of World Aquatics shall declare the new World Record or World Junior Record, see that such information is published, and see that certificates are provided to those persons whose applications have been accepted.

12.18 All records made during the Olympic Games, World Aquatics Championships, World Aquatics Junior Swimming Championships and Swimming World Cups shall be automatically approved.

12.19 If the procedure of II.12.14 has not been followed, the Member Federation in the country of a swimmer can apply for a World Record or a World Junior Record in default thereof. After due investigation, the Executive Director of World Aquatics is authorised to accept such record if the claim is found to be correct.

12.20 If the application for a World Record or a World Junior Record is accepted by World Aquatics, a diploma, signed by the President of World Aquatics shall be forwarded by the Executive Director to the Member Federation in the country of the swimmer for presentation to the swimmer in recognition of the performance. A fifth World Record diploma will be issued to all Member Federations whose relay teams establish a World Record or a World Junior Record. This diploma is to be retained by the Member Federation.

12.21 From time to time, World Aquatics may add new events for which swimmers may establish World Records or World Junior Records. For each such event, World Aquatics will establish Target Times; if a swimmer achieves a time that is better than the Target Time, it shall be considered a World Record or World Junior Record, as long as all requirements in II.12 are met.

13. AUTOMATIC OFFICIATING PROCEDURE

13.1 When Automatic Officiating Equipment (See II.16.3 Automatic Officiating Equipment for Swimming) is used in any competition, the placing and times so determined and relay take-offs judged by such equipment shall have precedence over the timekeepers and Inspectors of Turns.

13.2 When the Automatic Officiating Equipment fails to record the place and/or time of one or more swimmers in a given race:

13.2.1 Record all available Automatic Officiating Equipment times and places,

13.2.2 Record all human times and places.

13.2.3 The official place will be determined as follows:

13.2.3.1 A swimmer with an Automatic Officiating Equipment time and place must retain their relative order when compared with the other swimmers having an Automatic Officiating Equipment time and place within that race.

13.2.3.2 A swimmer not having an Automatic Officiating Equipment place but having an Automatic Officiating Equipment time will establish their relative order by comparing their Automatic Officiating Equipment time with the Automatic Officiating Equipment times of the other swimmers.

13.2.3.3 A swimmer having neither an Automatic Officiating Equipment place nor an Automatic Officiating Equipment time shall establish their relative order by the time recorded by the Semi-Automatic Officiating Equipment or by watches.

13.3 The official time will be determined as follows:

13.3.1 The official time for all swimmers having an Automatic Officiating Equipment time will be that time.

13.3.2 The official time for all swimmers not having an Automatic Officiating Equipment time will be the times recorded by Semi-Automatic Officiating Equipment or watches.

13.4 To determine the relative order of finish for the combined heats of an event, proceed as follows:

13.4.1 The relative order of all swimmers will be established by comparing their official times.

13.4.2 If a swimmer has an official time which is tied with the official time(s) of one or more swimmers, all swimmers having that time shall be tied in their relative order of finish in that event.

14. AGE GROUP RULES – SWIMMING

14.1 World Aquatics Junior Swimming Championships

Age groups shall be between 14-18 years, as of 31st December in the year of competition, for both Boys and Girls.

14.2 Minimum age for Olympic Games, World Aquatics Championships and World Aquatics Swimming Championships (25m).

The minimum age for swimmers competing in the Olympic Games, World Aquatics Championships and World Aquatics Swimming Championships (25m) shall be the same as the minimum age for the World Aquatics Junior Swimming Championships: Girls and Boys, at least 14 years of age, on 31st December in the year of competition. Younger competitors may participate in these competitions if they have achieved at least the “B” Standard Entry Time in the respective event.

14.3 Federations may adopt their own Age Group rules, using World Aquatics technical rules.

15. SWIMWEAR AND WEARABLES

15.1 Competitors must wear only one swimsuit in one or two pieces. No additional items, like arm bands or leg bands shall be regarded as parts of a swimsuit. All swimsuits shall comply with the requirements set forth in these Competition Regulations.

15.2 For swimming competitions, Swimsuits for men shall not extend above the navel nor below the knee. For women, the swimsuit shall not cover the neck, nor extend past the shoulder, nor below knee. The Swimsuits shall be made from textile materials.

15.3 No swimmer shall be permitted to use or wear any device or swimsuit that may aid his/her speed, buoyancy or endurance during a competition (such as webbed gloves, flippers, fins, power bands, or adhesive substances, etc.). The use of technology and automated data collection devices is permissible for the sole purpose of collecting data. Automated devices shall not be utilised to transmit data, sounds, or signals to the swimmer and may not be used to aid their speed. Goggles may be worn. As a consequence of injury, it is permissible to tape not more than one or two fingers or toes. Any other

kind of tape on the body is not permitted unless approved by the Referee or other designated person.

15.4 A World Record (including Junior World Record and Masters World Record) will only be recognised by World Aquatics if approved Swimwear has been used.

World Aquatics may request the Athlete to submit her/his swimsuit worn during the World Record for conducting further analysis in its laboratory.

16. SWIMMING FACILITIES AND EQUIPMENT

16.1 Swimming Facilities

16.1.1 Length

16.1.1.1 50.000 metres

When touch panels of Automatic Officiating Equipment are used on the starting end, or additionally on the turning end, the pool must be of such length that ensures the required distance of 50.000 metres between the two panels.

16.1.1.2 25.000 metres.

When touch panels of Automatic Officiating Equipment are used on the starting end, or additionally on the turning end, the pool must be of such length that ensures the required distance of 25.000 metres between the two panels.

16.1.2 Dimensional Tolerances

16.1.2.1 50m swimming pools

The admissible tolerance in 50.000 m swimming pools will be: +0.010, and - 0.000 metre when touch panels are installed.

Tolerances will be measured as follows:

For swimming pools with touch panels of Automatic Officiating Equipment on both ends the Wall to Wall distance shall be: Minimum 50.020 metre / Maximum 50.030 metre.

Tolerances have to be consistent 0.300 metre above to 0.800 metre below

the water surface.

These measurements should be certified by a surveyor or other qualified official, appointed or approved by the Member in the country in which the pool is situated.

16.1.2.2 25m swimming pools

The admissible tolerance in 25.000 m swimming pools will be +0.010, and - 0.000 metre when touch panels are installed.

Tolerances will be measured as follows:

For swimming pools with touch panels of Automatic Officiating Equipment on both ends the Wall to Wall distance shall be: Minimum

25.020 metre / Maximum 25.030 metre.

For swimming pools with a touch panel of Automatic Officiating Equipment on one end the Wall to Wall distance shall be: Minimum

25.010 metre / Maximum 25.020 metre.

Tolerances have to be consistent 0.300 metre above to 0.800 metre below the water surface.

These measurements should be certified by a surveyor or other qualified official, appointed or approved by the Member in the country in which the pool is situated.

16.1.3 Width

There is no minimum width requirement. However, the width of the pool has to comply with the provision II.16.1.6 Lanes.

16.1.4 Depth

A minimum depth of 1.35 metres, extending from 1.0 metre to at least 6.0 metres from the end wall is required for pools with starting blocks. A minimum depth of 1.0 metre is required elsewhere.

16.1.5 Walls

16.1.5.1 End walls shall be vertical, parallel and form 90-degree right angles to the swimming course and to the surface of the water. They shall be constructed of solid material, with a slip-resistant surface extending 0.8 metre below the water surface, so as to enable the competitor to touch and push off in turning

without hazard. The admissible tolerance in walls verticality will be ± 0.3 degrees.

16.1.5.2 Rest ledges along the pool walls are permitted; they must be not less than 1.2 metres below the water surface, and may be 0.1 metre to 0.15 metre wide. Both internal and external ledges are acceptable, however internal ledges are preferred.

16.1.5.3 Gutters may be placed on all four walls of the pool. If end wall gutters are installed, they must allow for attachment of touch panels to the required 0.3 metre above the water surface. They must be covered with a suitable grill or screen.

16.1.6 Lanes

There is no minimum number of lanes. Lanes shall be at least 2.5 metres wide, first and last lane may be 2.4 metres wide with 2 spaces of at least 0.1 metres wide outside of the first and the last lanes.

16.1.7 Lane Ropes

16.1.7.1 The main function of a lane rope is not only to separate swimming lanes, but to reduce the pool waves. A lane rope should have the properties to reduce the waves going through to the other side of rope or bouncing back into the swimming lane.

Lane ropes shall extend the full length of the course and components not contributing to its wave reduction function, such as tension spring and take-up reel, shall measure less than 200mm each end of rope.

Lane rope should be secured at each end wall to anchor brackets recessed into the end walls. If anchor placement is on pool deck, an extender, firm and non-elastic, should be in place. The installed lane rope should stay in the pool water. The anchor, including extender, shall not extend more than 10mm into the pool. The anchor shall not influence the length of the lane rope by more than ± 10 mm each end of rope.

The anchor shall be positioned so that the wave reducing components at each end wall of the pool shall be 50% below the surface of the water. Anchors should be installed to withstand 20kN. Each lane rope will consist of wave reducing components placed end-to-end having a minimum diameter of 0,10 metre. The design of discs and floats should be so that the floats, by

themselves, do not influence the length of the lane rope. A float should be an integral part in between two discs. The lane rope length of the course shall have a negative buoyancy in such a way that at least one half to maximum two thirds of the height of the wave reducing components should be beneath the water surface.

The take-up reel of the lane rope should require a tool to lock tensioning into position and to prevent non- authorized tampering. The lane rope shall be equipped with a tension spring, absorbing sudden high point loads and a wire withstanding a tensile force of 12kN.

In an eight (8) lane pool, lane ropes shall extend the full length of the course, secured at each end wall to anchor brackets recessed into the end walls. The anchor shall be positioned so that the floats at each end wall of the pool shall be on the surface of the water. Each lane rope will consist of floats placed end-to-end having a minimum diameter of 0.10 metre to a maximum of 0.15 metre.

In a swimming pool the colour of the lane ropes should be as follows, although variations in the colour scheme can be used:

- Two (2) GREEN ropes for lanes 1 and 8
- Four (4) BLUE ropes for lanes 2, 3, 6 and 7
- Three (3) YELLOW ropes for lanes 4 and 5

The floats extending for a distance of 5.0 metres from each end of the pool shall be of RED colour.

There shall not be more than one lane rope between each lane. The lane ropes shall be firmly stretched and the tensions should be 1-1,2kN.

16 See Swimming Diagrams, Annex 1, 6, and 7

16.1.7.2 At the 15-metre mark from each end wall of the pool the components shall be distinct in colour from the surrounding components.

16.1.7.3 In 50 metre pools the components shall be distinct to mark 25 metres.

16.1.7.4 Lane numbers of soft material may be placed on the lane ropes at the start and turning end of the pool.

16.1.8 Starting Platforms

Starting Platforms shall be firm and give no springing effect. The height of the platform above the water surface shall be from 0.5 metre to 0.75 metre. The surface area shall be at least 0.5 metre x 0.5 metre and covered with a slip-resistant material.

Maximum slope shall not be more than 10 degrees. The starting platform may have an adjustable setting back plate. The platform shall be constructed so as to permit the gripping of the platform by the swimmer in the forward start at the front and the sides; it is recommended that, if the thickness of the starting platform exceeds 0.04 metre, grips of at least 0.1 metre width on each side and 0.4 metre width in the front be cut out to 0.03 metre from the surface of the platform.

Handgrips for the forward start may be installed on the sides of the starting platforms. Handgrips for backstroke starts shall be placed within 0.3 metre to 0.6 metre above the water surface both horizontally and vertically. They shall be parallel to the surface of the end wall and must not protrude beyond the end wall.

A minimum depth of 1.35 metres, extending from 1.0 metre to at least 6.0 metres from the end wall is required for pools with starting blocks. Electronic read-out boards may be installed under the blocks. Flashing is not allowed. Figures must not move during a backstroke start.

16.1.9 Numbering

Each starting block must be distinctly numbered on all four sides, clearly visible. It is recommended that lane number 0 shall be on the right-hand side when facing the course from the starting end with exception of 50m events, which may start from the opposite end. Touch panels may be numbered on the top part.

16.1.10 Backstroke Turn Indicators

Flagged ropes shall be suspended across the pool, 1.8 metres above the water surface, from fixed standards placed 5.0 metres from each end wall. Distinctive marks must be placed on both sides of the pool, and where possible on each lane rope, 15.0 metres from each end wall.

Flags must be fixed to the ropes having the following dimensions: 0.20 metres on the rope forming a triangle measuring 0.40 metres on the sides. The distance between each flag must be 0.25 metres. If the flags are printed with or support / carry any signage this must be approved in advance by

World Aquatics.

16.1.11 Backstroke Ledge

Backstroke ledges conforming to the specification set out below shall be used in all World Aquatics Championships and Competitions.

The ledge:

- shall be adjustable to 4 cm above or 4 cm below the water level and may not be used outside of this range;
- is a minimum of 65 cm in length;
- must be 8 cm in height, 2 cm at the width with 10 degrees of slope.

16 See Diagram

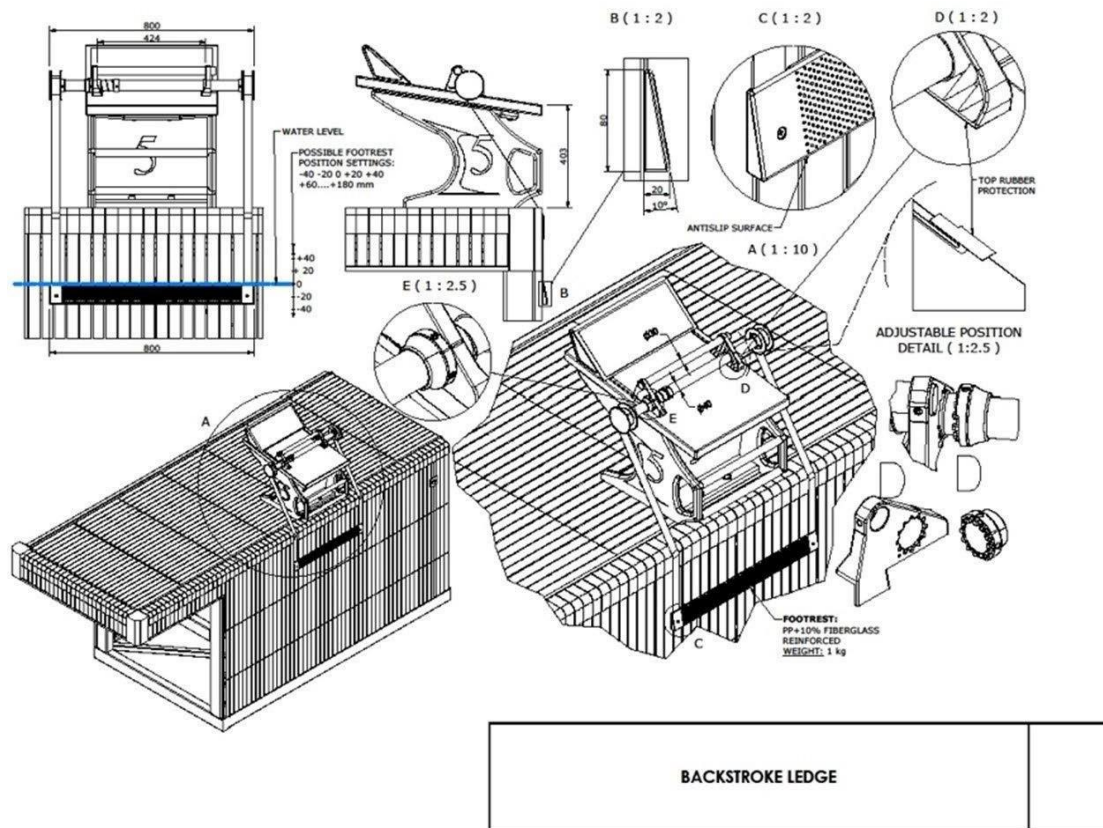

16.1.12 False Start Rope

False Start Rope may be suspended across the pool not less than 1.2 metres above the water level from fixed standards placed 15.0 metres in front of the starting end. It shall be attached to the standards by a quick release mechanism. The rope must effectively cover all lanes when activated.

16.1.13 Water conditions

16.1.13.1 Water Temperature

Water temperature shall be 25° to 28°C.

16.1.13.2 Water Movement

During competition, the water in the pool must be at a constant level, with no appreciable movement.

In order to keep the water level, preserve the transparency of water and take into consideration the health regulations in force in most countries, inflow and outflow has to be regulated as follows:

- 220 to 250 m³/h for 50.00 m pools
- 150 to 180 m³/h for 33.33 m pools
- 120 to 150 m³/h for 25.00 m pools

In daily use, inflow and outflow has to follow the health regulation of each country.

At these turnover rates, the water distribution has to be such that no appreciable current or turbulence is created.

“Appreciable current” is defined as water movement that can move a floating basketball (filled with 6 litres of water to obtain the right buoyancy) in one direction for more than 1,25m in 60 seconds.

The practical way to test this is to install two floating lines crosswise in a swim lane (to obtain a square with 2,5m size, ref. Image 1) and then to leave the basketball in the central point of the square. If the ball does not touch any of the four lane ropes within 60 seconds, the turbulence test is successful.

Test should be repeated in lanes 1,3,6,8 on two sides, at 5m from each end of the pool (end wall or bulkhead).



16.1.13.3 Salinity of the water

World Records and World Junior Records can be established only in water with less than 3 gr/litre of salt.

No World Records will be recognized in any kind of sea or ocean water.

16.1.14 Lighting

Light intensity over starting platforms and turning ends shall not be less than 600 lux.

16.1.15 Lane Markings

Lane Markings shall be of a dark contrasting colour, placed on the floor of the pool in the centre of each lane.

Width: minimum 0.2 metre, maximum 0.3 metre.

Length: 46.0 metres for 50 metre long pools;

21.0 metres for 25 metre long pools.

Each lane line shall end 2.0* metres from the end wall of the pool with a distinctive cross line 1.0 metre long and of the same width as the lane line. The distance between the centre points of each lane shall be 2.5 metres.

*17 *Pool length tolerances must be considered.*

Target lines shall be placed on the end walls or on the touch panels, in the centre of each lane, of the same width as the lane lines.

They shall extend without interruption from the deck edge (curb), to the floor of the pool to a maximum of 3 metres. A cross line 0.5 metre long shall be placed 0.3 metre below the water surface, measured to the centre point of the cross line.

For 50m and 25m pools constructed after 1st January 2006, cross lines 0.5 metre long shall be placed at the 15 metre mark from each end of the pool. After October 2013 this shall be measured from the end wall to the centre point of the cross line.

16.1.16 Bulkheads

When a bulkhead serves as an end wall, it must extend the full width of the course and present a solid smooth, non-slippery stable vertical surface on which touch pads may be mounted extending not less than 0.8m below and 0.3m

above the surface of the water, and must be free of hazardous openings above or below the waterline which may be penetrated by a swimmer's hands, feet, toes or fingers. A bulkhead must be of a design that provides for the free movement of officials along its length without such movement creating any appreciable current or water turbulence.

16.2 Swimming Facilities for Olympic Games and World Aquatics Championships

16.2.1 Length

50.0 metres between the Automatic Officiating Equipment touch panels, except for the World Aquatics Swimming Championships (25m), which shall be 25.0 metres between the Automatic Officiating Equipment touch panels at the starting end and the wall or touch panels at the turning end.

16.2.2 Dimensional Tolerances

16.2.2.1 50m swimming pools

The admissible tolerance in 50.00 m swimming pools will be +0.010, and - 0.000 metre when touch panels are installed.

Tolerances will be measured as follows:

For swimming pools with touch panels of Automatic Officiating Equipment on both ends the Wall-to-Wall distance shall be: Minimum 50.020 metre / Maximum 50.030 metre.

Tolerances have to be consistent 0.300 metre above to 0.800 metre below the water surface.

These measurements should be certified by a surveyor or other qualified official, appointed or approved by the Member in the country in which the pool is situated.

See Swimming Diagrams: Annex 1, 2, 3, and 4

16.2.2.2 25m swimming pools

The admissible tolerance in 25.00 m swimming pools will be +0.010, and - 0.000 metre when touch panels are installed. Tolerances will be measured as follows:

For swimming pools with touch panels of Automatic Officiating Equipment on both ends the Wall to Wall distance shall be: Minimum 25.020 metre /

Maximum 25.030 metre.

For swimming pools with a touch panel of Automatic Officiating Equipment on one end the Wall to Wall distance shall be: Minimum 25.010 metre / Maximum 25.020 metre.

Tolerances have to be consistent 0.300 metre above to 0.800 metre below the water surface.

These measurements should be certified by a surveyor or other qualified official, appointed or approved by the Member in the country in which the pool is situated.

16.2.3 Width

16.2.3.1 Olympic Games

Permanent Swimming Pools: A minimum of 25.00 metres Temporary Swimming Pools: 26.00 metres.

16.2.3.2 World Aquatics Championships

Permanent Swimming Pools: A minimum of 25.00 metres Temporary Swimming Pools: 26.00 metres.

16.2.4 Depth

16.2.4.1 Olympic Games and World Aquatics Championships (50m)

A minimum of 2.5 metres.

16.2.4.2 World Aquatics Swimming Championships (25m)

A minimum of 2.0 metres, 2.5 metres preferred.

16.2.4.3 When the pool is used for multi-sports (i.e., Artistic Swimming and Swimming) at either the Olympic Games or World Aquatics Championships

A minimum of 3 metres required.

16.2.5 Walls

16.2.5.1 End walls shall be vertical, parallel and form 90-degree right angles to the swimming course and to the surface of the

water. They shall be constructed of solid material, with a slip-resistant surface extending 0.8 metre below the water surface, so as to enable the competitor to touch and push off in turning without hazard.

The admissible tolerance in walls verticality will be ± 0.3 degrees.

16.2.5.2 Rest ledges along the pool walls are permitted; they must be not less than 1.2 metres below the water surface, and may be 0.1 metre to 0.15 metre wide. Both internal and external ledges are acceptable, however internal ledges are preferred.

16.2.5.3 Gutters may be placed on all four walls of the pool. If end wall gutters are installed, they must allow for attachment of touch panels to the required 0.3 metre above the water surface. They must be covered with a suitable grill or screen.

16.2.6 Lanes

16.2.6.1 Number of lanes:

Eight (8) lanes for Olympic Games, although 9 or 10 lanes may be used with approval from the Chair of the Technical Swimming Committee when faced with unusual circumstances. *[Example: a tie from preliminaries for 8th place in the 1500-metre freestyle]*

Ten (10) lanes for World Aquatics Championships.

16.2.6.2 Olympic Games

Lanes shall be 2.5 metres wide with 2 spaces 2.5 metres wide outside of lanes 1 and 8. There must be a lane rope separating these spaces from lanes 1 and 8. *See Swimming Diagram: Annex 1*

16.2.6.3 World Aquatics Championships

For permanent swimming pools, lanes from 1 to 8 shall be 2.5 metres wide and lanes 0 and 9 shall be 2.4 metres wide with 2 spaces 0.1 metres wide outside of lanes 0 and 9. There must be a lane rope separating these spaces from lanes 0 and 9 for World Championships. *See Diagrams: Annex 2 and 8*

For temporary swimming pools, lanes shall be 2.5 metres wide with 2 spaces 0.5 metres wide outside of lanes 0 and 9. There must be a lane rope a separating these spaces from lanes 0 and 9. *See Diagrams: Annex 3 and 9*

16.2.7 Lane Ropes

16.2.7.1 The main function of a lane rope is not only to separate swimming lanes, but to reduce the pool waves. A lane rope should have the properties to reduce the waves going through to the other side of rope or bouncing back into the swimming lane.

Lane ropes shall extend the full length of the course, secured at each end wall to anchor brackets recessed into the end walls. The anchor shall be positioned so that the floats at each end wall of the pool shall be on the surface of the water. Each lane rope will consist of floats placed end-to-end having a minimum diameter of 0.15 metre.

Lane rope should be secured at each end wall to anchor brackets recessed into the end walls. If anchor placement is on pool deck, an extender, firm and non-elastic, should be in place.

The installed lane rope should stay in the pool water. The anchor, including extender, shall not extend more than 10mm into the pool. The anchor shall not influence the length of the lane rope by more than $\pm 10\text{mm}$ each end of rope.

The anchor shall be positioned so that the wave reducing components at each end wall of the pool shall be 50% below the surface of the water. Anchors should be installed to withstand 20kN. Each lane rope will consist of wave reducing components placed end-to-end having a diameter of 0, 15 metre. The design of discs and floats should be so that the floats, by themselves, do not influence the length of the lane rope. A float should be an integral part in between two discs. The lane rope length of the course shall have a negative buoyancy in such a way that at least one half to maximum two thirds of the height of the wave reducing components should be beneath the water surface.

The take-up reel of the lane rope should require a tool to lock tensioning into position and to prevent non-authorized tampering. The lane rope shall be equipped with a tension spring, absorbing sudden high point loads and a wire withstanding a tensile force of 12kN.

The components extending for a distance of 5.0 metres from each end of the pool shall be of RED colour.

There shall not be more than one lane rope between each lane. The lane

ropes shall be firmly stretched and the tensions should be 1-1,2kN.

In a swimming pool the colour of the lane ropes should be as follows:

16.2.7.1.1 Olympic Games

In an eight (8) lane swimming pool the colour of the lane ropes should be as follows, although variations in the colour scheme can be used:

- Two (2) GREEN ropes for lanes 1 and 8
- Four (4) BLUE ropes for lanes 2, 3, 6 and 7
- Three (3) YELLOW ropes for lanes 4 and 5

| | | | |
|----------|--|---------------|--|
| | | | |
| 1 | | GREEN | |
| 2 | | BLUE | |
| 3 | | BLUE | |
| 4 | | YELLOW | |
| 5 | | YELLOW | |
| 6 | | YELLOW | |
| 7 | | BLUE | |
| 8 | | BLUE | |
| | | GREEN | |
| | | | |

16.2.7.1.2 World Aquatic Championships

In a ten (10) lane swimming pool the colour of the lane ropes should be as follows, although variations in the colour scheme can be used:

- Two (2) GREEN ropes for lanes 0 and 9
- Six (6) BLUE ropes for lanes 1, 2, 3, 6, 7 and 8
- Three (3) YELLOW ropes for lanes 4, 5

18 See Swimming Diagrams, Annex 2, 3, 8, and 9

The floats extending for a distance of 5.0 metres from each end of the pool shall be of RED colour.

| | | | |
|----------|--|---------------|--|
| | | GREEN | |
| 0 | | BLUE | |
| 1 | | BLUE | |
| 2 | | BLUE | |
| 3 | | BLUE | |
| 4 | | YELLOW | |
| 5 | | YELLOW | |
| 6 | | YELLOW | |
| 7 | | BLUE | |
| 8 | | BLUE | |
| 9 | | BLUE | |
| | | GREEN | |

16.2.7.2 At the 15-metre mark from each end wall of the pool the components shall be distinct in colour from the surrounding components.

16.2.7.3 In 50 metre pools the components shall be distinct to mark 25 metres.

16.2.7.4 Lane numbers of soft material may be placed on the lane ropes at the start and turning end of the pool.

16.2.7.5 Lane marking measurements, please read in conjunction with pool diagrams.

16.2.8 Starting Platforms

Starting Platforms shall be firm and give no springing effect. The height of the platform above the water surface shall be from 0.5 metre to 0.75 metre. The surface area shall be at least 0.5 metre x 0.6 metre and covered with a slip- resistant material.

Maximum slope shall not be more than 10 degrees. The starting platform may have an adjustable setting back plate. The platform shall be constructed so as to permit the gripping of the platform by the swimmer in the forward start at the front and the sides; it is recommended that, if the thickness of the starting platform exceeds 0.04 metre, grips of at least 0.1 metre width on each side and 0.4 metre width in the front be cut out to 0.03 metre from the surface of the platform.

Handgrips for the forward start may be installed on the sides of the starting platforms. Handgrips for backstroke starts shall be placed within 0.3 metre to 0.6 metre above the water surface both horizontally and vertically. They

shall be parallel to the surface of the end wall and must not protrude beyond the end wall.

A minimum depth of 1.35 metres, extending from 1.0 metre to at least 6.0 metres from the end wall is required for pools with starting blocks. Electronic read-out boards may be installed under the blocks. Flashing is not allowed. Figures must not move during a backstroke start.

16.2.9 Numbering

Each starting block must be distinctly numbered on all four sides, clearly visible. It is recommended that lane number 0 shall be on the right-hand side when facing the course from the starting end with exception of 50m events, which may start from the opposite end. Touch panels may be numbered on the top part.

16.2.10 Backstroke turn indicators

Flagged ropes shall be suspended across the pool, 1.8 metres above the water surface, from fixed standards placed 5.0 metres from each end wall. Distinctive marks must be placed on both sides of the pool, and where possible on each lane rope, 15.0 metres from each end wall.

Flags must be fixed to the ropes having the following dimensions: 0.20 metres on the rope forming a triangle measuring 0.40 metres on the sides. The distance between each flag must be 0.25 metres. If the flags are printed with or support / carry any signage this must be approved in advance by World Aquatics.

16.2.11 Backstroke Ledge

A backstroke ledge may be used:

- The ledge may be adjustable to 4 cm above or 4 cm below the water level.
- The ledge is a minimum of 65 cm in length.
- The ledge must be 8 cm in height, 2 cm at the width with 10 degrees of slope.

19 *See Diagram*

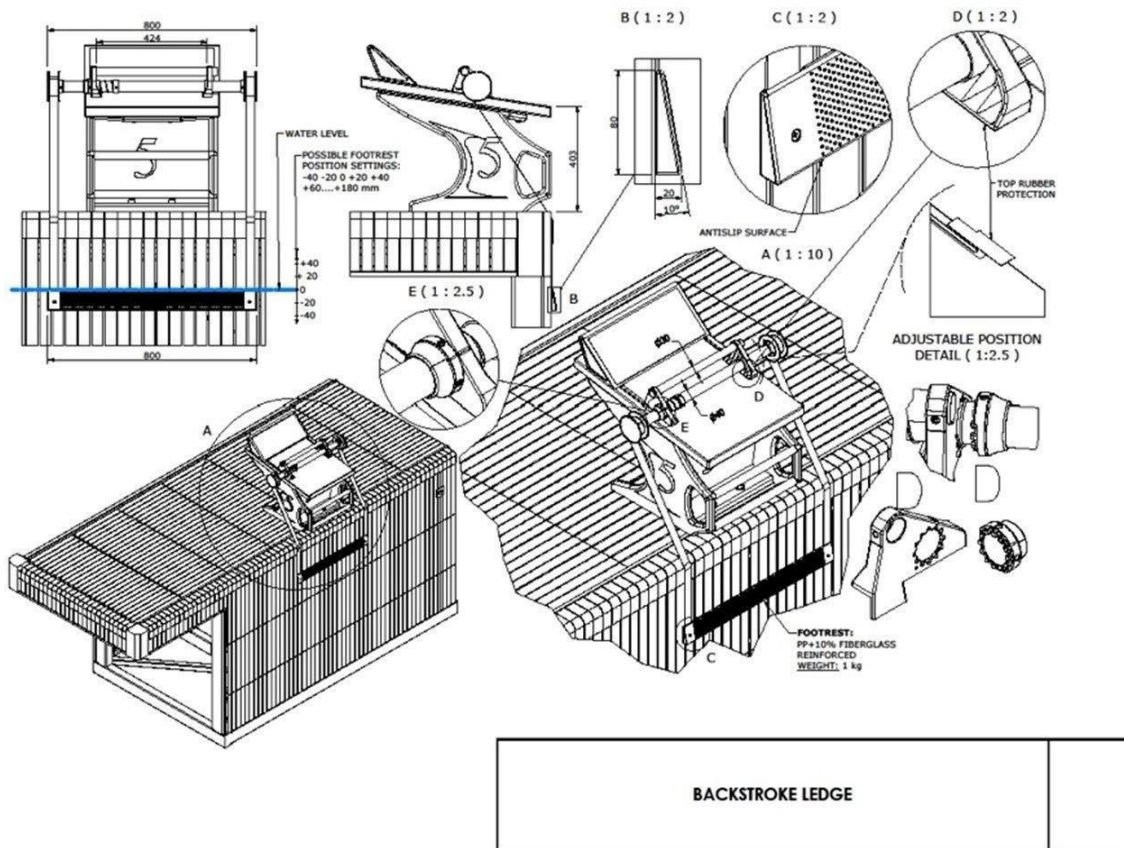

16.2.12 False Start Rope

False Start Rope may be suspended across the pool not less than 1.2 metres above the water level from fixed standards placed 15.0 metres in front of the starting end. It shall be attached to the standards by a quick release mechanism. The rope must effectively cover all lanes when activated.

16.2.13 Water conditions

16.2.13.1 Water Temperature

Water temperature shall be 25°C to 28°C.

16.2.13.2 Water Movement

During competition, the water in the pool must be at a constant level, with no appreciable movement.

In order to keep the water level, preserve the transparency of water and take into consideration the health regulations in force in most countries, inflow and outflow has to be regulated as follows:

- 220 to 250 m³/h for 50.00 m pools

- 150 to 180 m³/h for 33.33 m pools
- 120 to 150 m³/h for 25.00 m pools

In daily use, inflow and outflow has to follow the health regulation of each country.

At these turnover rates, the water distribution has to be such that no appreciable current or turbulence is created.

“Appreciable current” is defined as water movement that can move a floating basketball (filled with 6 litres of water to obtain the right buoyancy) in one direction for more than 1,25m in 60 seconds.

The practical way to test this is to install two floating lines crosswise in a swim lane (to obtain a square with 2,5m size, ref. Image 1) and then to leave the basketball in the central point of the square. If the ball does not touch any of the four lane ropes within 60 seconds, the turbulence test is successful.

Test should be repeated in lanes 1,3,6,8 on two sides, at 5m from each end of the pool (end wall or bulkhead).



16.2.13.3 Salinity of the water

World Records and World Junior Records can be established only in water with less than 3 gr/litre of salt.

No World Records will be recognized in any kind of sea or ocean water.

16.2.14 Lighting

Light intensity over the whole pool shall not be less than 1500 lux.

16.2.15 Lane Markings

Lane Markings shall be of a dark contrasting colour, placed on the floor of the pool in the centre of each lane.

Width: minimum 0.2 metre, maximum 0.3 metre.

Length: 46.0 metres for 50 metre long pools; 21.0 metres for 25 metre long pools.

Each lane line shall end 2.0* metres from the end wall of the pool with a distinctive cross line 1.0 metre long and of the same width as the lane line. The distance between the centre points of each lane shall be 2.5 metres.

16 *Pool length tolerances must be considered.

Target lines shall be placed on the end walls or on the touch panels, in the centre of each lane, of the same width as the lane lines. They shall extend without interruption from the deck edge (curb), to the floor of the pool to a maximum of 3 metres. A cross line 0.5 metre long shall be placed 0.3 metre below the water surface, measured to the centre point of the cross line.

For 50m and 25m pools constructed after 1st January 2006, cross lines 0.5 metre long shall be placed at the 15 metre mark from each end of the pool. After October 2013 this shall be measured from the end wall to the centre point of the cross line.

16.2.16 Bulkheads

When a bulkhead serves as an end wall, it must extend the full width of the course and present a solid smooth, non-slippery stable vertical surface on which touch pads may be mounted extending not less than 0.8m below and 0.3m above the surface of the water, and must be free of hazardous openings above or below the waterline which may be penetrated by a swimmer's hands, feet, toes or fingers. A bulkhead must be of a design that provides for the free movement of officials along its length without such movement creating any appreciable current or water turbulence.

16.2.17 Minimum distance separating the pools

If the swimming pool and the diving well are in the same area the minimum distance separating the pools shall be 5.0 metres. For pools constructed from 1st January 2014 the minimum distance separating the pool shall be a minimum of 8 metres however 10 metres is preferred.

16.3 Automatic officiating Equipment for Swimming

16.3.1 General description

Automatic and Semi-Automatic Officiating Equipment records the elapsed time of each swimmer and determines the relative place in a race. Judging and timing shall be to 2 decimal places (1/100 of a second). Equipment that is installed shall not interfere with the swimmers' starts, turns, or the function of the overflow system.

16.3.2 Equipment requirements

The Equipment must:

16.3.2.1 Be activated by the starter.

16.3.2.2 Have no exposed wires on the pool deck, if possible.

16.3.2.3 Be able to display all recorded information for each lane by place and by lane.

16.3.2.4 Provide easy digital reading of a swimmer's time.

16.3.3 Starting devices

16.3.3.1 The starter shall have a microphone for oral commands.

16.3.3.2 If a pistol is used, it shall be used with a transducer.

16.3.3.3 Both the microphone and the transducer shall be connected to loudspeakers at each starting block where both the starter's commands and the starting signal can be heard equally and simultaneously by each swimmer.

16.3.3.4 False start detection equipment must be installed.

16.3.4 Touch panels for Automatic Equipment

16.3.4.1 The minimum measurement of the touch panels shall be 2.4 metres wide and 0.9 metre high, and the thickness shall be 0.01m when the contact is closed (and the time is stopped).

They shall extend 0.3 metre above and 0.6 metre below the surface of the water. The equipment in each lane shall be electronically connected

independently, so it may be controlled and maintained individually. The surface of the panels shall be of a bright colour and shall bear the line markings approved for the end walls.

16.3.4.2 Installation - The touch panels shall be installed in a fixed position in the centre of the lanes. The panels may be portable, allowing the pool operator to remove them when there are no competitors.

16.3.4.3 Sensitivity - The sensitivity of the panels shall be such that they cannot be activated by water turbulence, but will be activated by a light hand touch. The panels shall be sensitive on the top edge.

16.3.4.4 Markings - The markings on the panels shall conform with and superimpose on the existing markings of the pool. The perimeter and edges of the panels shall be defined by a 0.025 metre black border.

16.3.4.5 Safety - The panels shall be safe from the possibility of electrical shock and shall not have sharp edges.

16.3.5 Semi-Automatic Equipment

With Semi-Automatic Equipment, the finish shall be recorded by buttons pushed by timekeepers at the finish touch of the swimmer.

16.3.5.1 Semi-Automatic Equipment may be used as a backup to the Automatic Officiating Equipment at World Aquatics or other major events if there are three buttons per lane, each operated by a separate official (in which case other finish judges shall not be required). An inspector of turns may operate one of the buttons.

16.3.6 Automatic Equipment – Essential Accessories

The following accessories are essential for a minimum installation of Automatic Equipment:

16.3.6.1 Printout of all information, which can be regenerated during a succeeding race.

16.3.6.2 Spectator readout board.

16.3.6.3 Relay take-off judging to 1/100 of a second. Where overhead video cameras are installed they may be reviewed as a supplement to the automatic system's judgement of relay take-off. For the differential in the relays take-off the manufacturer of the device shall be consulted.

16.3.6.4 Automatic lap counter.

16.3.6.5 Readout of splits.

16.3.6.6 Computer summaries.

16.3.6.7 Correction of erroneous touch.

16.3.6.8 Automatic rechargeable battery operation possibility.

16.3.7 Automatic Equipment – Accessories for Olympic Games and World Aquatics Championships

For Olympic Games and World Aquatics Championships the following accessories are also essential:

16.3.7.1 The spectator electronic read-out board shall contain at least twelve (12) lines of thirty-two (32) characters, each capable of displaying both letters and numbers. Each character shall have a minimum height of 360 mm. Each line – matrix scoreboard shall be able to scroll up or down, with blink function, and each full matrix scoreboard shall be programmable, and capable of showing animation. The board must have a minimum size of 7.5 m width by 4.5m height.

16.3.7.2 There shall be an air-conditioned control room, with dimensions of a least 6.0 metres x 3.0 metres, located between 3.0 metres and 5.0 metres from the finish wall, with an unobstructed view of the finish wall at all times during the race. The referee must have easy access to the control centre during the competition. At all other times the control room shall be able to be secured.

16.3.7.3 Video judging and timing

16.3.8 Timing room

Timekeepers shall have a clear view on the finish pool side from the Timing

room. Sponsor panels or LED wall shall be installed at a minimum of 2m distance from the finish wall Timing room side. The panels or LED wall shall not exceed the length of 46m.

17 See Diagram

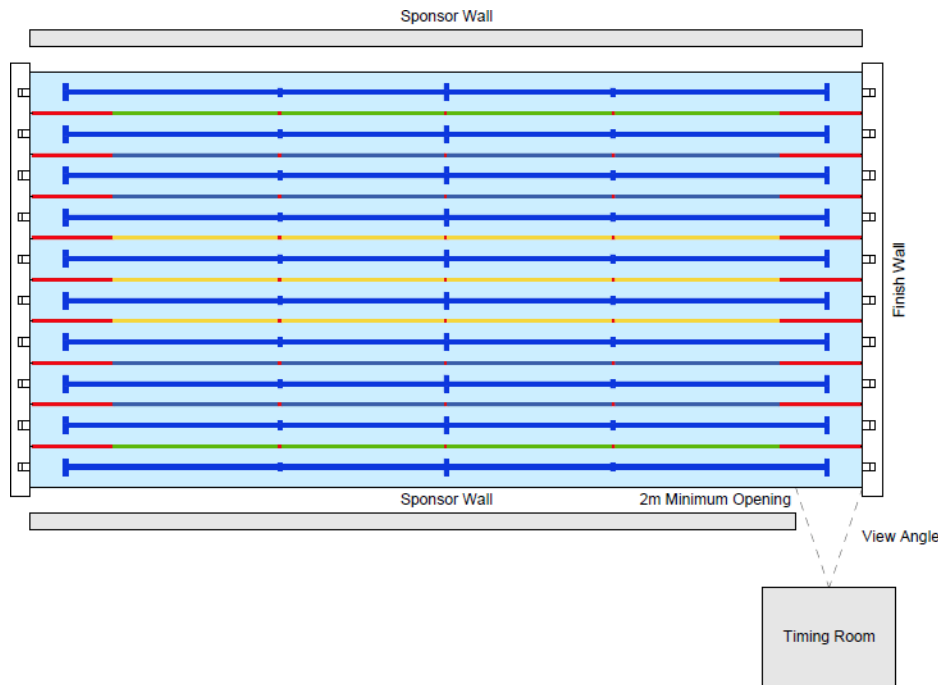

16.3.9 Video Judging Equipment

At Olympic Games and World Championships approved Automatic Officiating Equipment, including Video Judging Equipment shall be provided and used. The approved Video Judging Equipment shall be used to initiate stroke infraction calls, confirm stroke infraction calls or assist the Referee to overturn calls made on the pool deck.

17. Medical and Safety specific requirement for Swimming

The Medical Requirements are described in the section I.9.2. However, each sport has unique components.

17.1 Pre-competition trainings

Swimming competitions are generally composed of two competition sessions: one in the morning and one in the afternoon/evening. Prior to the races, the swimmers will be present at the venue to train. They generally arrive 2.5 - 3 hours before the beginning of the competition. It implies that an important number of athletes are swimming but also walking around the pool, and exercising/stretching. This proximity can lead to collisions in and out of the water.

Pre-competition training is a critical period as numerous swimmers in the pool are training at the same time and are practising various elements of their race (e.g the start) or are swimming different strokes. While lanes are dedicated to each practice, accident/collision can occur.

In addition, at major events, the numbers of swimmers in the warm-up pool area could be particularly high. The numbers of lifeguards shall therefore be adjusted to appropriately cover the different swimming pools.

17.2 Location of the FoP First Aid Treatment Area

Ideally, for the competition pool, the Field of Play (FoP) First Aid Treatment Area should be positioned where the athletes exit the water without obstructing the mixed zone on the pool deck.

17.3 Water Rescue and Lifeguards

Lifeguards should practice water retrieval on a daily basis during the event. In Swimming, it is important to remember that the swimming pools are separated by the lane ropes that could block the access to the swimmer during the water rescue. This point must be taken into consideration while practising and the extraction point should be adjusted.

It is recommended to have 3 lifeguards by swimming-pool. Two lifeguards next to the FoP Treatment area and a third lifeguard positioned on the opposite side.

ANNEX 1 – Diagram Swimming Pool 50x25m – 8 Lane

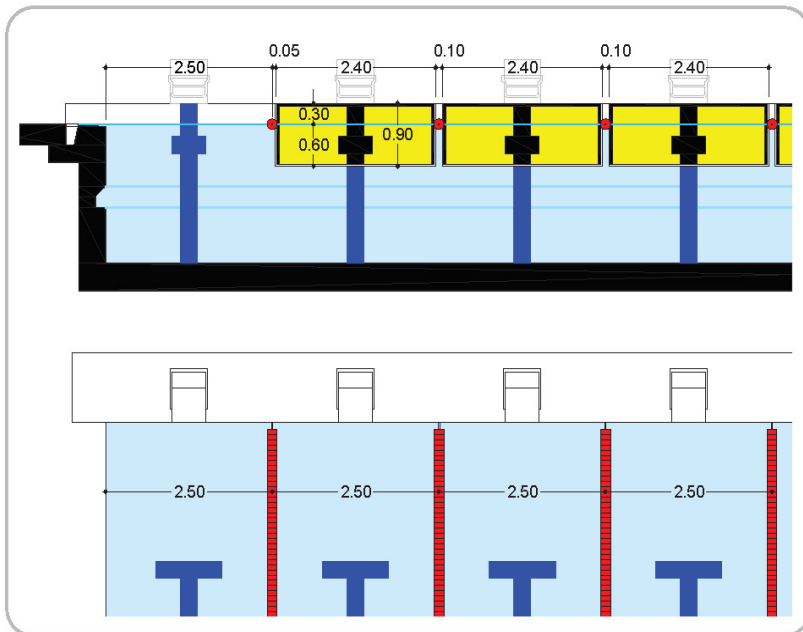
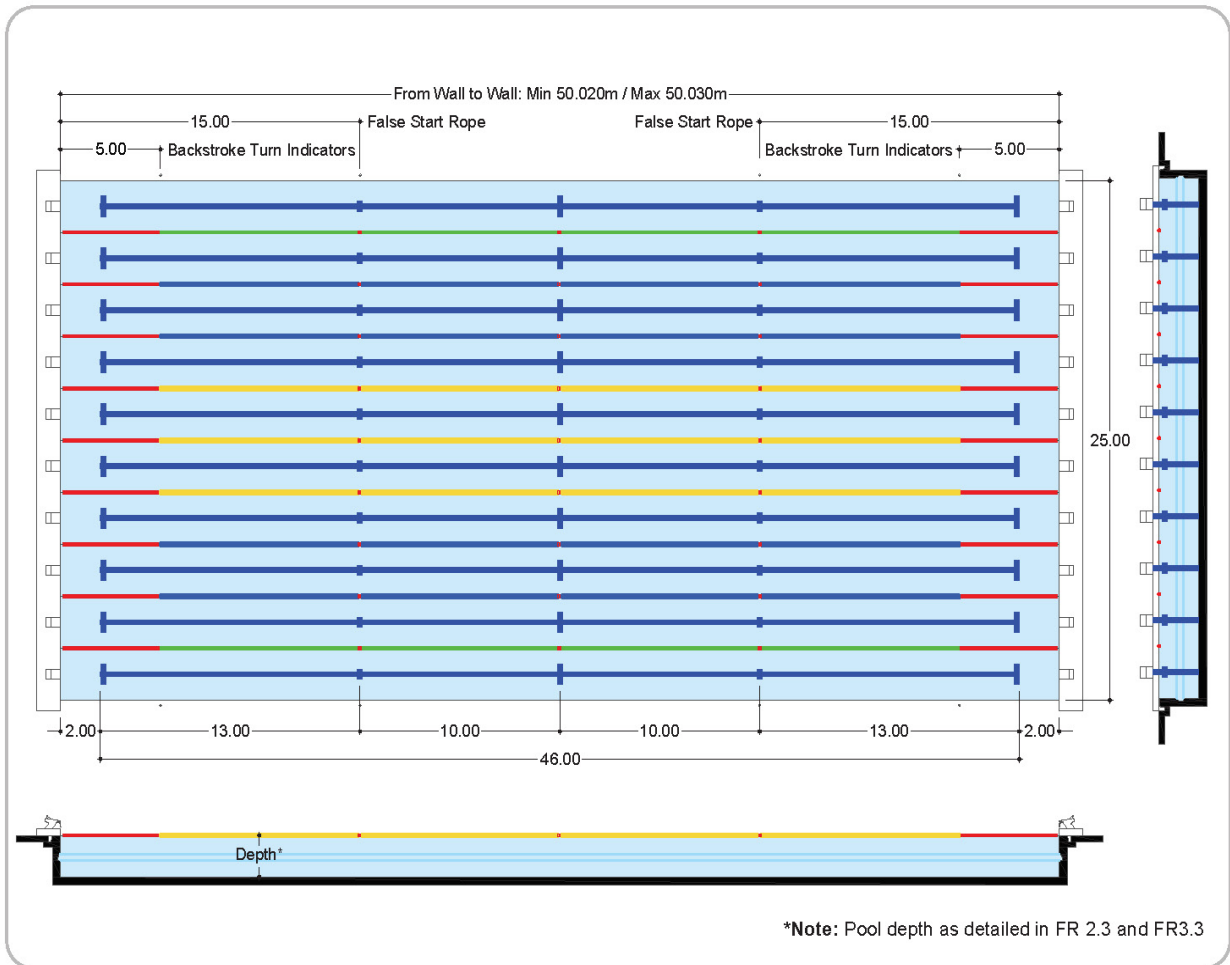

| | |
|---|--------|
| 0 | |
| 1 | Green |
| 2 | Blue |
| 3 | Blue |
| 4 | Yellow |
| 5 | Yellow |
| 6 | Blue |
| 7 | Blue |
| 8 | Green |
| 9 | |

Lane Ropes

In a 8 (eight) lanes swimming pool the colour of the lane ropes should be as follows:

- Two (2) GREEN ropes for lanes 1 and 8.
- Four (4) BLUE ropes for lanes 2, 3, 6 and 7.
- Three (3) YELLOW ropes for lanes 4, 5.

ANNEX 2 – DIAGRAM SWIMMING POOL 50X25m – 10 Lanes

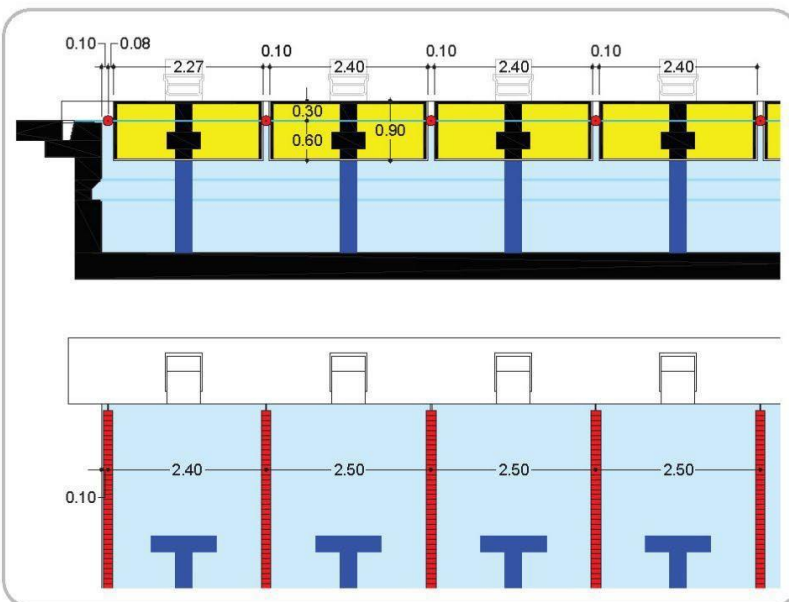
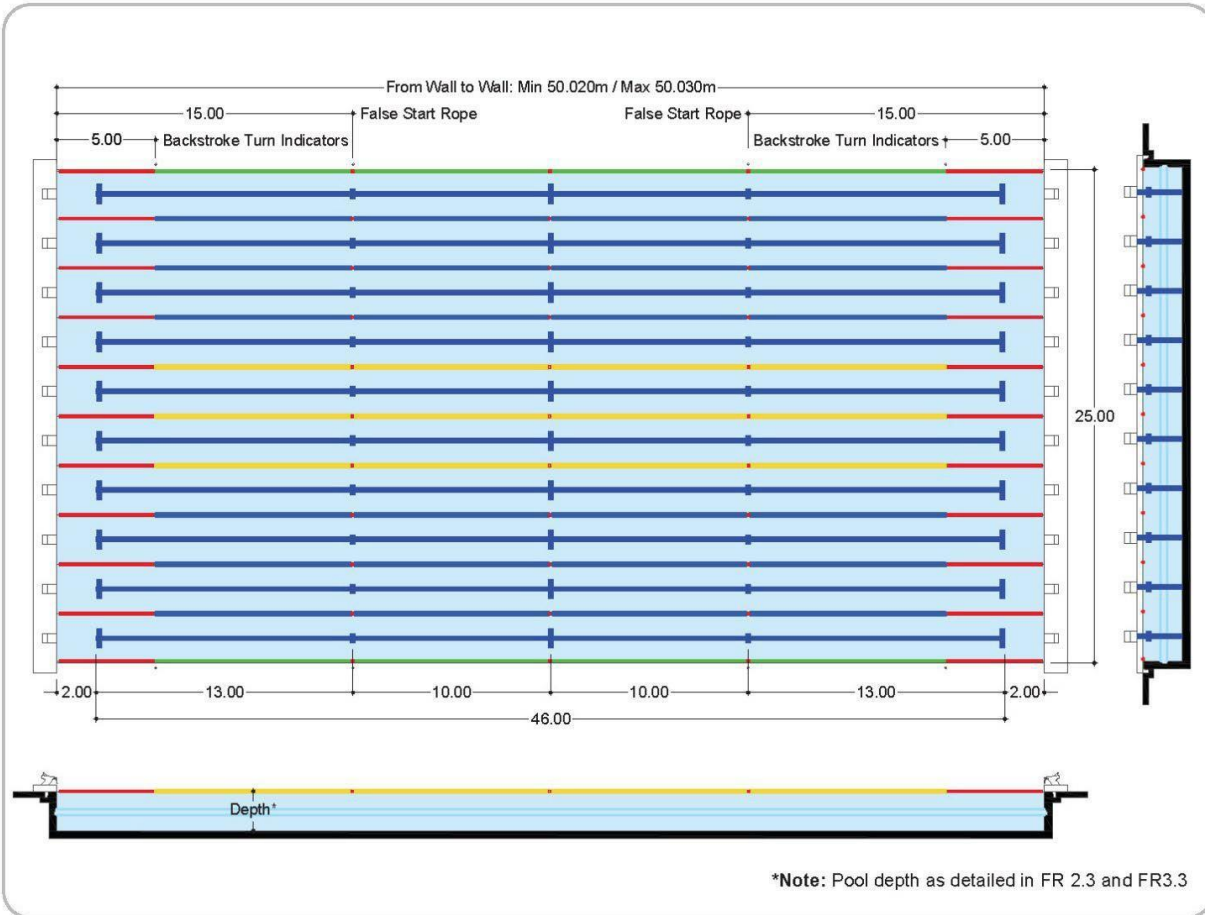

Lane Ropes

In a 10 (ten) lanes swimming pool the colour of the lane ropes should be as follows:

- Two (2) GREEN ropes for lanes 0 and 9.
- Six (6) BLUE ropes for lanes 1, 2, 3, 6, 7 and 8.
- Three (3) YELLOW ropes for lanes 4, 5.

ANNEX 3 – DIAGRAM SWIMMING POOL 50X25m – 10 Lanes

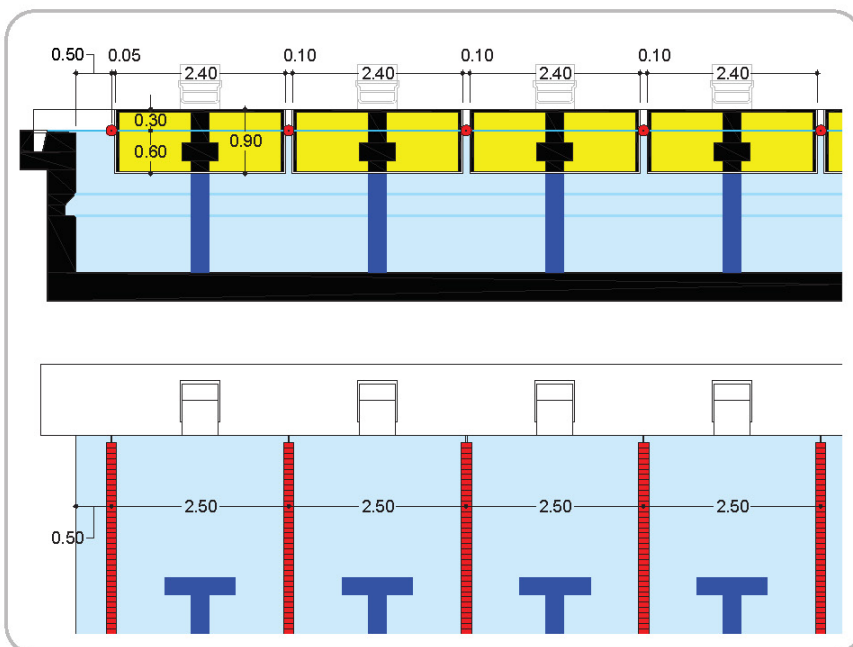
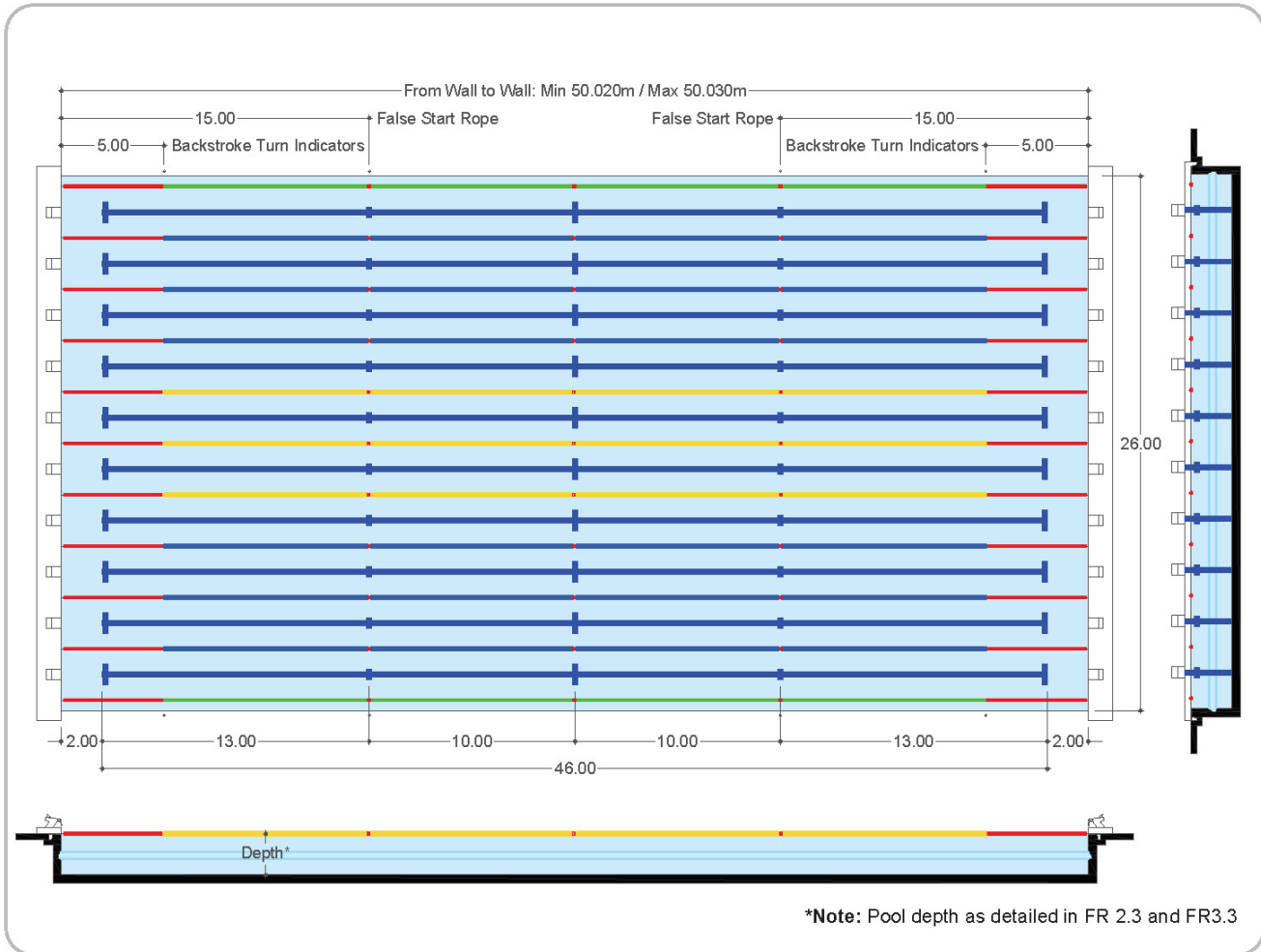

Lane Ropes

In a 10 (ten) lanes swimming pool the colour of the lane ropes should be as follows:

- Two (2) GREEN ropes for lanes 0 and 9.
- Six (6) BLUE ropes for lanes 1, 2, 3, 6, 7 and 8.
- Three (3) YELLOW ropes for lanes 4, 5.

ANNEX 4 – DIAGRAM SWIMMING POOL 50X25 WITH ONE BULKHEAD IN LATERAL POSITION

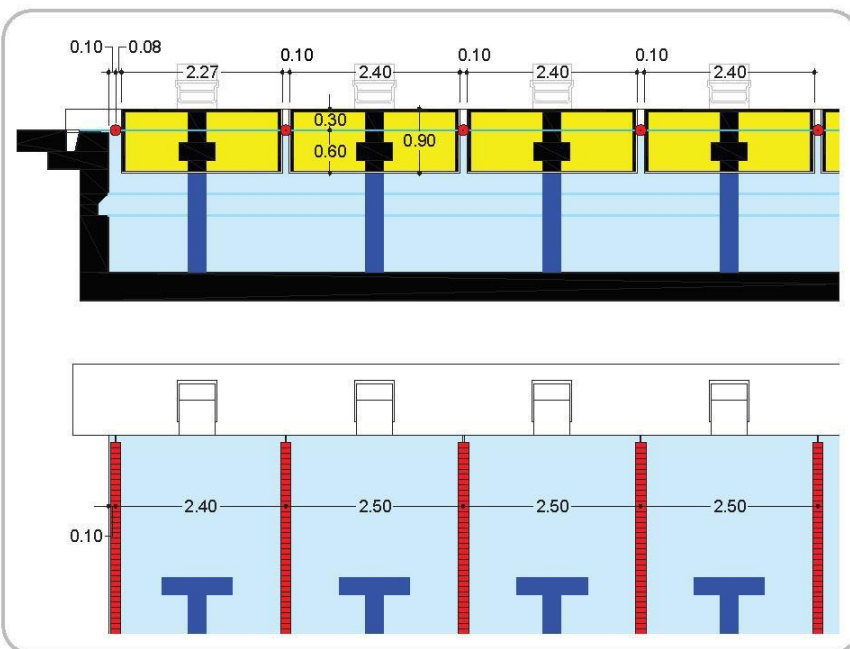
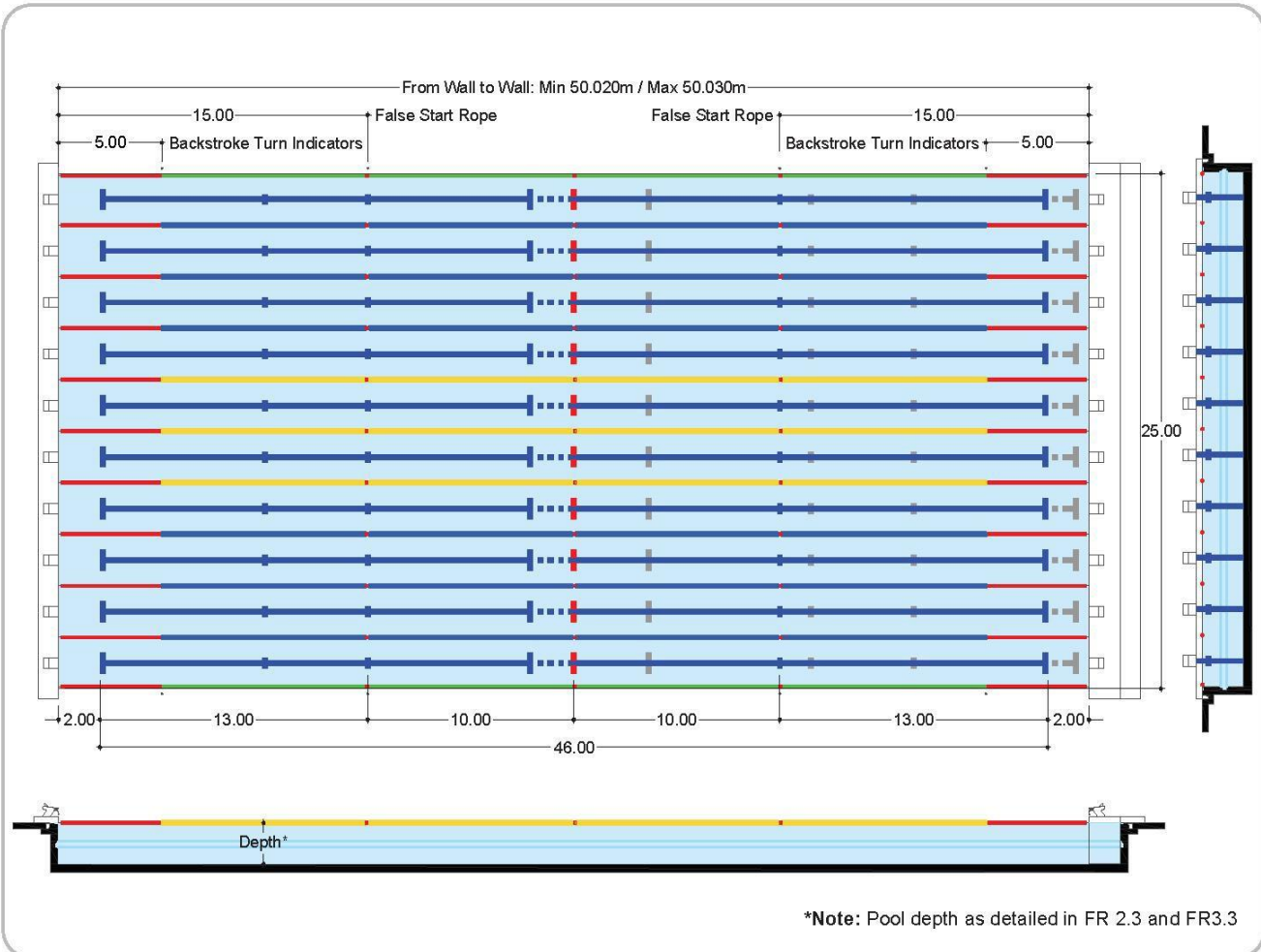

Lane Ropes

In a 10 (ten) lanes swimming pool the colour of the lane ropes should be as follows:

- Two (2) GREEN ropes for lanes 0 and 9.
- Six (6) BLUE ropes for lanes 1, 2, 3, 6, 7 and 8.
- Three (3) YELLOW ropes for lanes 4, 5.

**ANNEX 5 – DIAGRAM SWIMMING POOL 50X25M WITH ONE BULKHEAD –
BULKHEAD IN CENTRAL POSITION**

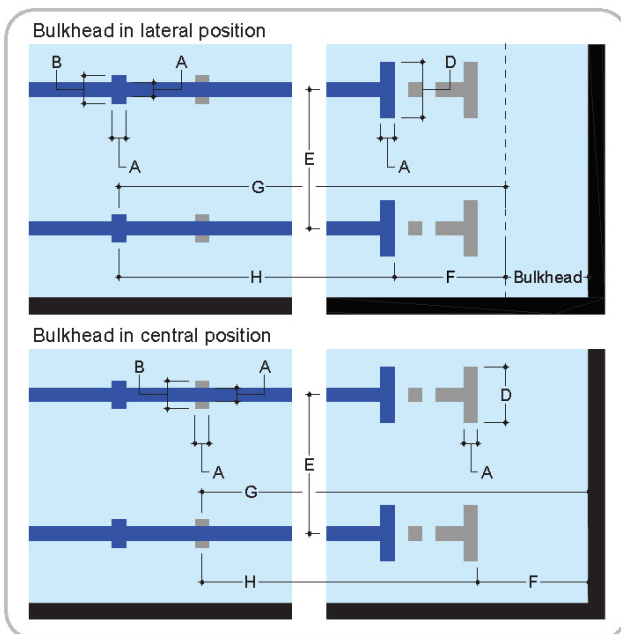
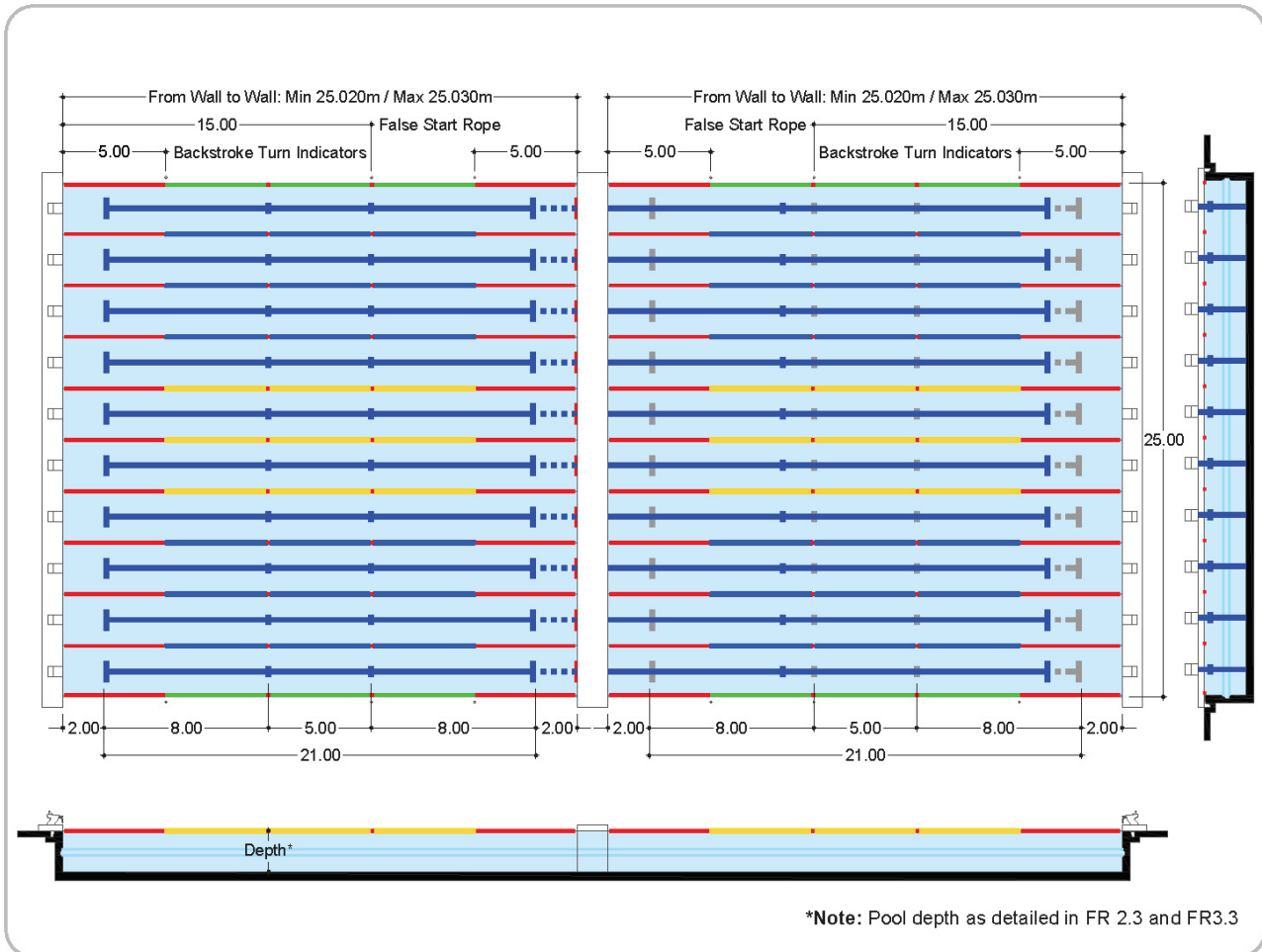

Lane Markings

| | | |
|--|---|---------------|
| Width of lane markings, end, lines targets | A | 0.25m ± 0.05m |
| Length of end wall targets | B | 0.50m |
| Depth to centre of end wall targets | C | 0.30m |
| Length of lane marker cross line | D | 1.00m |
| Width of racing lanes | E | 2.50m |
| Distance from end of lane line to end wall | F | 2.00m* |
| Distance from centre of cross line to end wall | G | 15.00m* |
| Distance from end of lane line to centre of cross line | H | 13.00m |
| Distance from centre of cross line to end wall | I | 25.00m* |

** Pool tolerance has to be considered*

ANNEX 6 – DIAGRAM SWIMMING POOL 25X21M – 8 Lanes

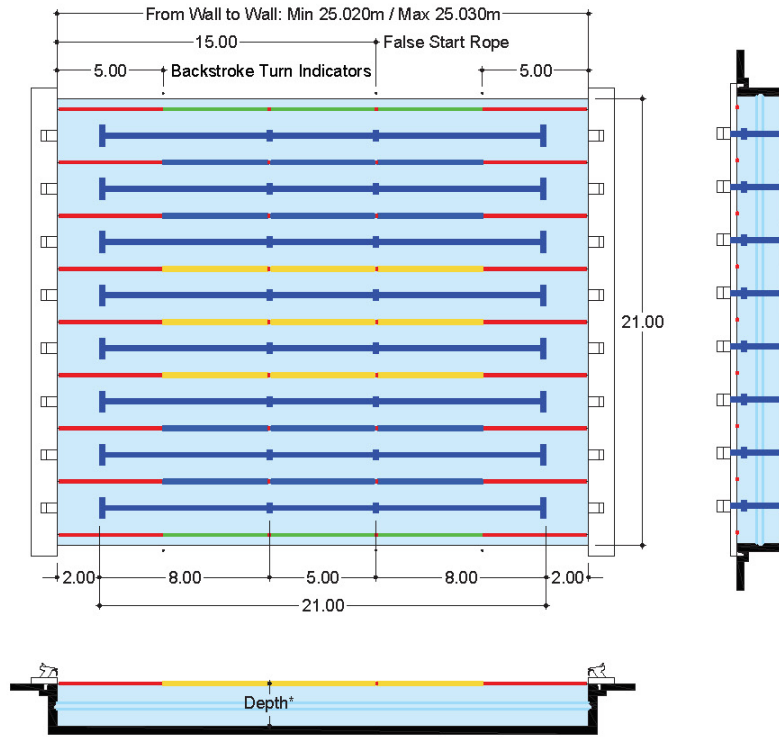

*Note: Pool depth as detailed in FR 2.3 and FR3.3

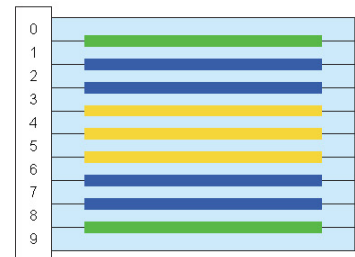
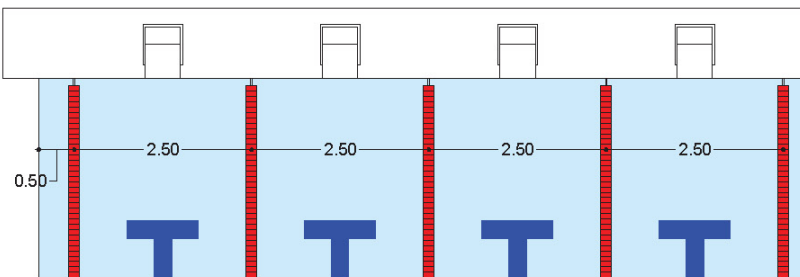
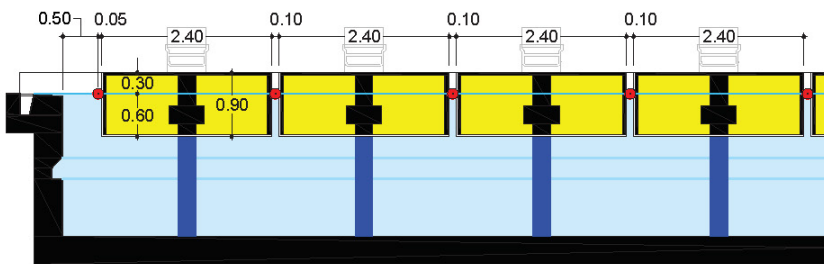

Lane Ropes

In a 8 (eight) lanes swimming pool the colour of the lane ropes should be as follows:

- Two (2) GREEN ropes for lanes 1 and 8.
- Four (4) BLUE ropes for lanes 2, 3, 6 and 7.
- Three (3) YELLOW ropes for lanes 4, 5.

ANNEX 7 – DIAGRAM SWIMMING POOL 25X21M – 8 Lanes

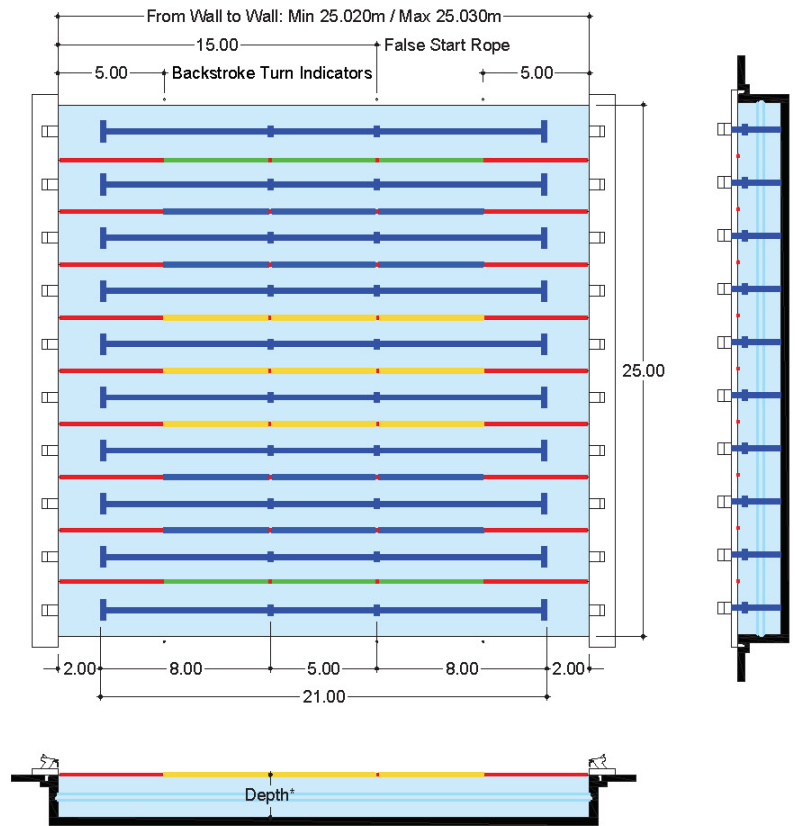

*Note: Pool depth as detailed in FR 2.3 and FR3.3

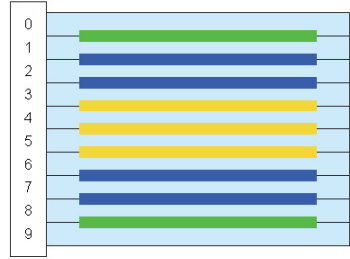
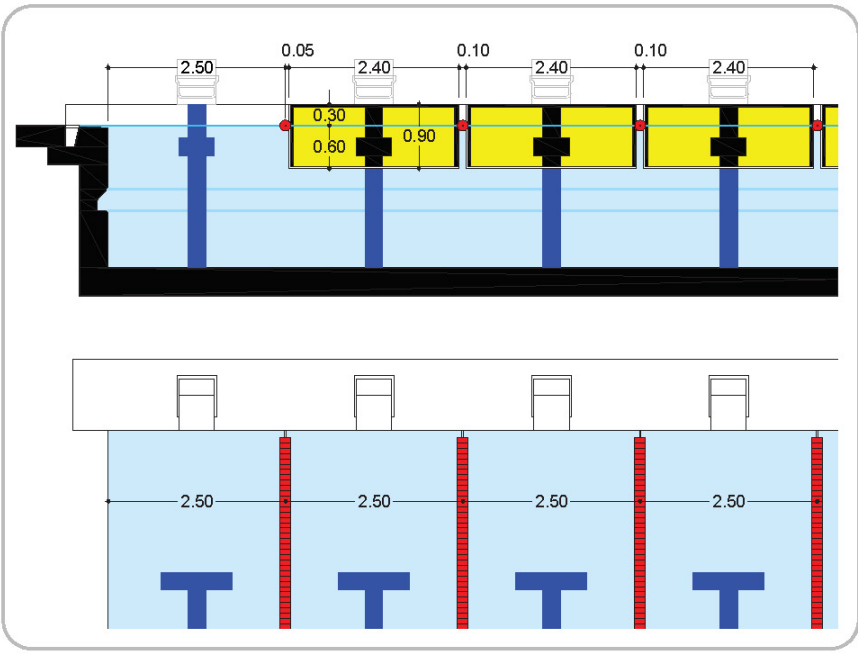

Lane Ropes

In a 8 (eight) lanes swimming pool the colour of the lane ropes should be as follows:

- Two (2) GREEN ropes for lanes 1 and 8.
- Four (4) BLUE ropes for lanes 2, 3, 6 and 7.
- Three (3) YELLOW ropes for lanes 4, 5.

ANNEX 8 - DIAGRAM SWIMMING POOL 25X25M – 10 Lanes

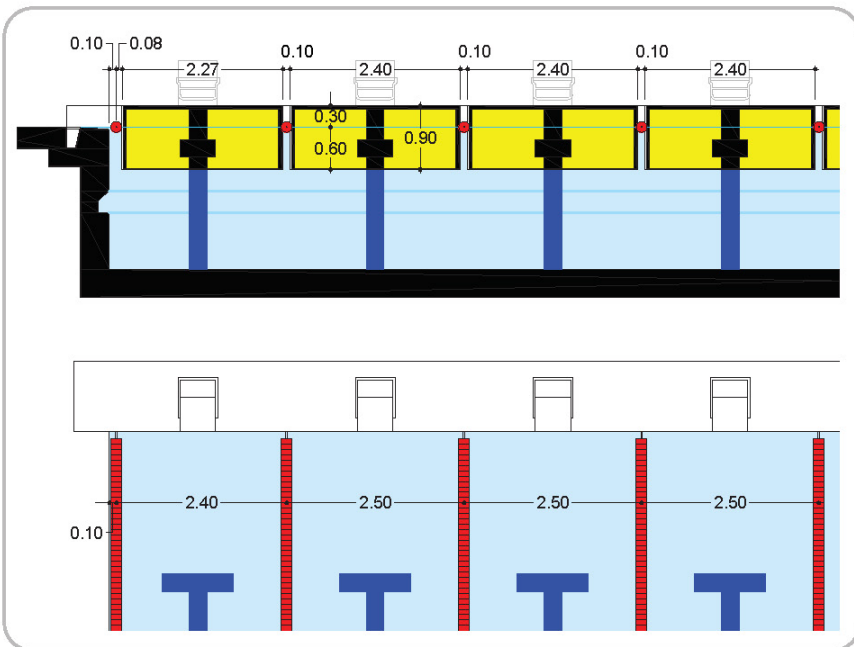
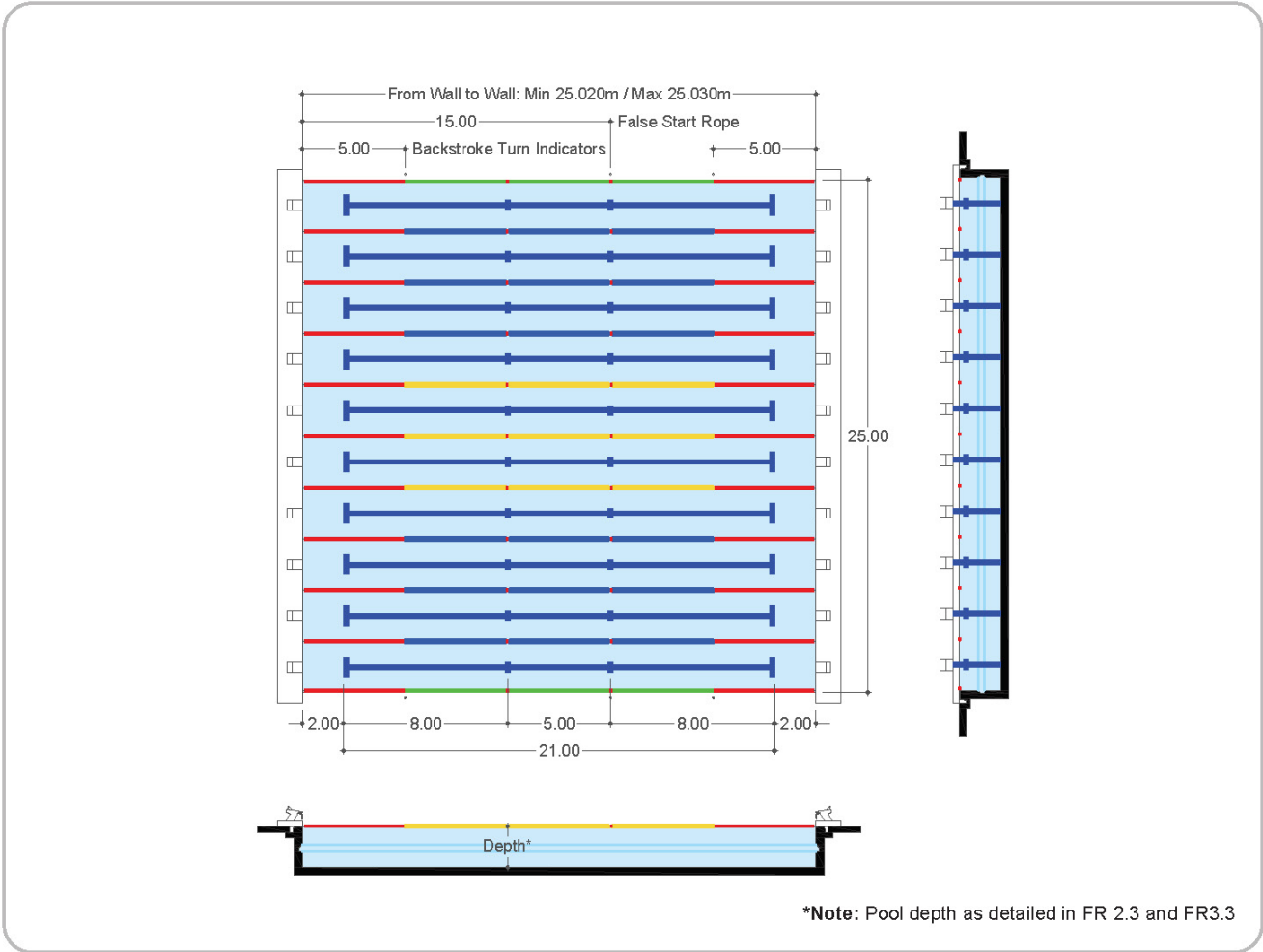

| | |
|---|--------|
| 0 | Green |
| 1 | Blue |
| 2 | Blue |
| 3 | Blue |
| 4 | Yellow |
| 5 | Yellow |
| 6 | Blue |
| 7 | Blue |
| 8 | Blue |
| 9 | Green |

Lane Ropes

In a 10 (ten) lanes swimming pool the colour of the lane ropes should be as follows:

- Two (2) GREEN ropes for lanes 0 and 9.
- Six (6) BLUE ropes for lanes 1, 2, 3, 6, 7 and 8.
- Three (3) YELLOW ropes for lanes 4, 5.

ANNEX 9 - DIAGRAM SWIMMING POOL 25X26M – 10 Lanes

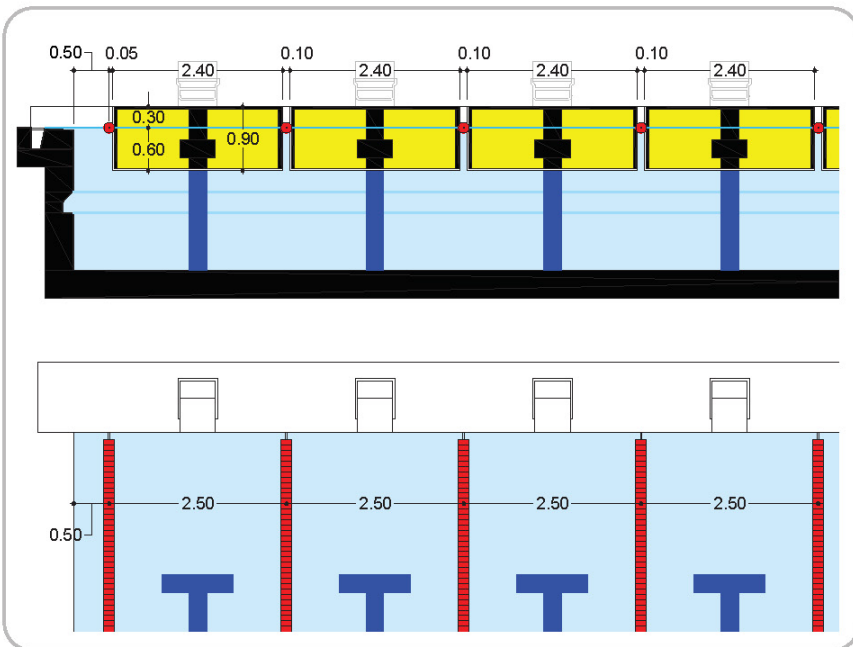
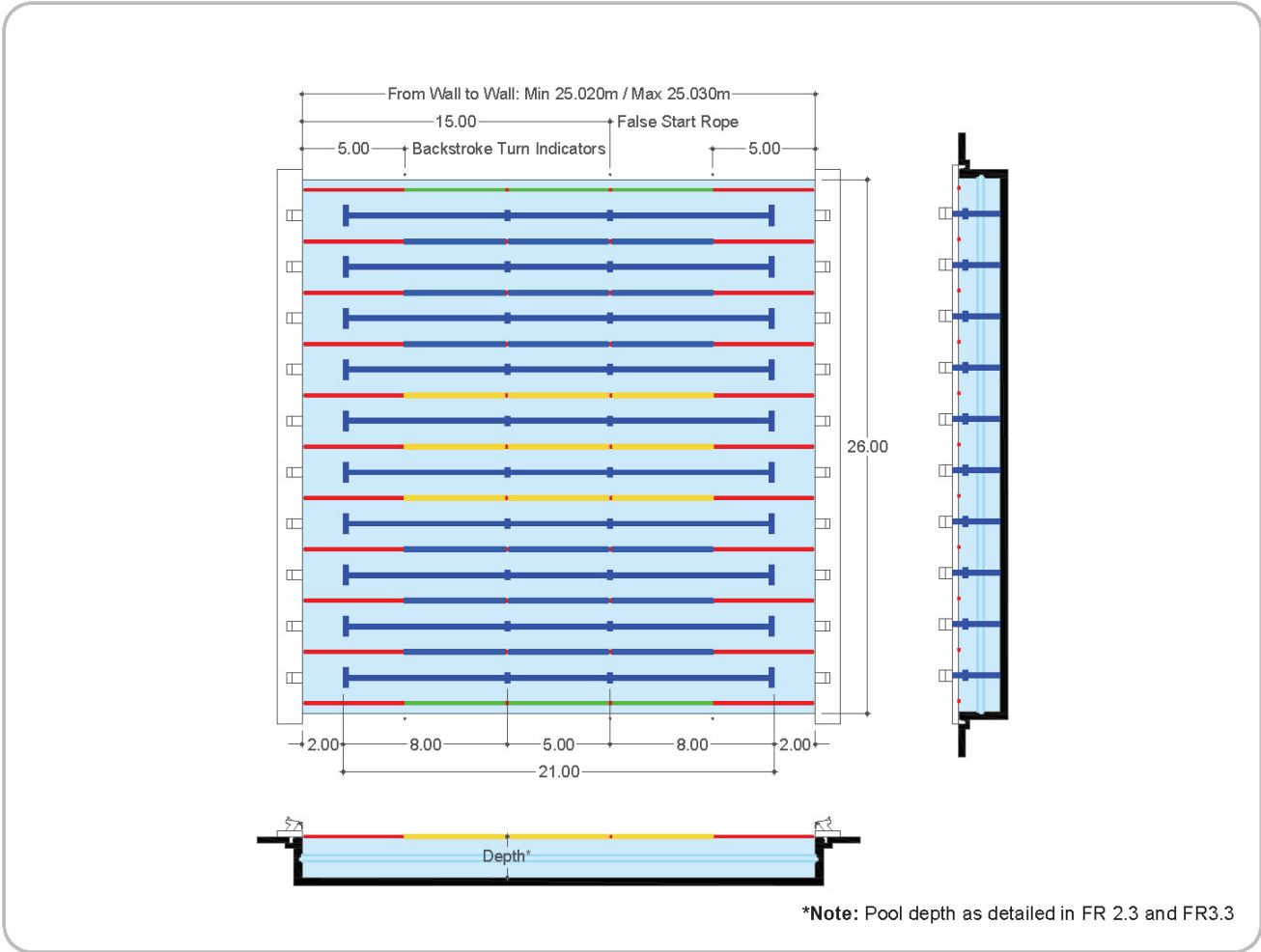

| | |
|---|--------|
| 0 | Green |
| 1 | Blue |
| 2 | Blue |
| 3 | Blue |
| 4 | Yellow |
| 5 | Yellow |
| 6 | Blue |
| 7 | Blue |
| 8 | Blue |
| 9 | Green |

Lane Ropes

In a 10 (ten) lanes swimming pool the colour of the lane ropes should be as follows:

- Two (2) GREEN ropes for lanes 0 and 9.
- Six (6) BLUE ropes for lanes 1, 2, 3, 6, 7 and 8.
- Three (3) YELLOW ropes for lanes 4, 5.

ANNEX 10 - DIAGRAM 50m SWIMMING POOL – Lane markings

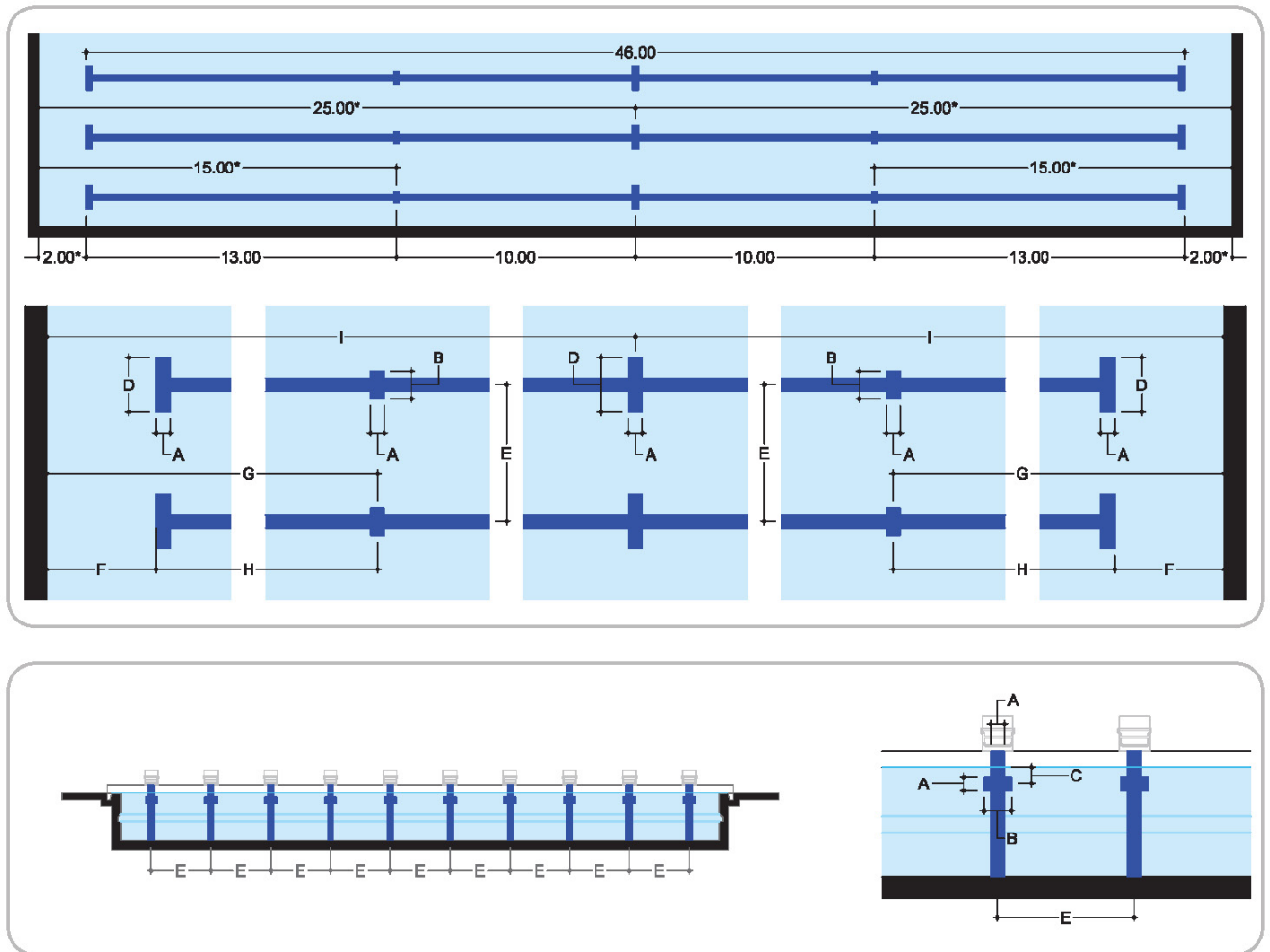

Lane Markings

| | | |
|--|----|---------------|
| Width of lane markings, end, lines targets | A | 0.25m ± 0.05m |
| Length of end wall targets | B | 0.50m |
| Depth to centre of end wall targets | C | 0.30m |
| Length of lane marker cross line | D | 1.00m |
| Width of racing lanes | E | 2.50m |
| Distance from end of lane line to end wall | F* | 2.00m* |
| Distance from centre of cross line to end wall | G | 15.00m* |
| Distance from end of lane line to centre of cross line | H | 13.00m |
| Distance from centre of cross line to end wall | I | 25.00m* |

** Pool tolerance has to be considered*

PART THREE: OPEN WATER SWIMMING

1. WORLD AQUATICS CHAMPIONSHIPS AND OLYMPIC GAMES

1.1 Program of the Olympic Games

| <u>Men</u> | <u>Women</u> |
|---------------|---------------|
| 10 kilometres | 10 kilometres |

1.2 Open Water Swimming - World Aquatics Championships

| <u>Men</u> | <u>Women</u> | <u>Mixed</u> | <u>Team</u> |
|---------------|---------------|--------------|--------------|
| | | <u>Event</u> | |
| 10 kilometres | 10 kilometres | -- | |
| 5 kilometres | 5 kilometres | -- | |
| | | | 4x1500 Relay |

1.2.1 Description of the Mixed Team Race

- Two (2) females and two (2) male competitors from the same country
- Each competitor shall complete a lap of 1.5 km.
- competitors may swim in any sequence, but may only swim once.
- All teams will start together.
- Starting order on the platform will be by random draw.
- There shall be a change-over zone of a minimum of 5 m in length of sufficient size for the teams competing.
- Changeovers shall be made with the following competitor in the water in their starting position holding the platform, except where a relay change platform is used.
- Contact on the relay changeover must be visible. The touch, between the competitors making the changeover, should be made above the water anywhere between the elbow and the hand when the changeover is in the water. Where a relay

change platform is used, the following competitor may start with a dive from the opposite side of the platform immediately after the arriving competitor touches the platform.

- Competitors may enter the change-over zone when the previous competitor is approaching the zone and leave the water immediately at the conclusion of their lap.
- Departing competitors must dive from the start position allocated to their team.
- Competitors shall all wear team caps of the same colour and style.

1.3 The **minimum age** for swimmers competing in the Olympic Games and World Aquatics Championships shall be the same as the minimum age for the World Aquatics Junior Open Water Swimming Championships: Girls and Boys, at least 14 years of age, on 31st December in the year of competition.

1.4 World Aquatics Junior Open Water Swimming Championships

1.4.1 Age Groups

The Age Groups as of 31st December of the year of the competition are:

- 14-15 years Boys and Girls
- 16-17 years Boys and Girls
- 18-19 years Boys and Girls

1.4.2 Individual Events

- 14-15 years 5 km Boys and Girls
- 16-17 years 7.5 km Boys and Girls
- 18-19 years 10 km Boys and Girls

1.4.3 Mixed Team Relays

1.4.3.1 The distance

Mixed 4 x 1500m

1.4.3.2 Description of the Race

As per Rule 1.2.1

1.4.3.3 Competition Program

Day 1

Morning 14-15 years 5 km

Afternoon 16-17 years 7.5 km

Day 2

Morning 18-19 years 10 km

Day 3

Morning 14-16 years Relay Event
Afternoon Open Relay Event

2. OFFICIALS

The following officials shall be appointed at Open Water Swimming competitions:

- A Chief Referee (one per race)
- Referees (2 minimum, additional Referees proportional to race entries)
- Chief Timekeeper plus 2 Timekeepers
- Chief Finish Judge plus 2 Finish Judges
- Safety Officer
- Medical Officer
- Course Officer
- Clerk of the Course
- Race Judges (one per competitor) except for events with a course of 10 km or less
- Turn Judges (one per alteration of Course)
- Feeding Platform Judge (when feeding platforms are used)

- Relay Judge
- Starter
- Announcer
- Recorder

NOTE: No official can act in more than one role simultaneously. They may only undertake a new role after all of the obligations of their previous role have been fulfilled.

3. DUTIES OF OFFICIALS

3.1 Chief Referee

The Chief Referee shall:

3.1.1 have full control and authority over all officials and shall approve their assignments and instruct them regarding all special features or regulations related to the competition. The Chief Referee shall enforce all the Rules and decisions of World Aquatics and shall decide all questions relating to the actual conduct of the competition, the final settlement of which is not otherwise covered by these Rules.

3.1.2 have authority to intervene in the competition at any stage to ensure that World Aquatics Rules are observed.

3.1.2.1 In case of hazardous conditions that jeopardize the safety of the competitors and the officials, in conjunction with the Safety Officer she/he can stop the race.

3.1.3 adjudicate on all protests related to the competition in progress.

3.1.4 give a decision in cases where the Finish Judges' decisions and times recorded do not agree.

3.1.5 signal to competitors, by raised flag and short blasts on a whistle, that the start is imminent and when satisfied indicate by pointing the flag at the Starter that the competition may commence.

3.1.6 disqualify any competitor for any violation of the Rules that she/he personally observes, or which is reported to her/him by other authorised officials. Notwithstanding the provisions of III.5.3 hereof, the Chief Referee may decide to enforce the disqualification at the

end of the race.

3.1.7 ensure that all necessary officials for the conduct of the competition are at their respective posts. She/He may appoint substitutes for any who are absent, incapable of acting or found to be inefficient. She/He may appoint additional officials if considered necessary.

3.1.8 receive all reports prior to the start of the race and at the conclusion of the race from the Clerk of the Course, Recorder, Course Officer and Safety Officer to ensure all competitors are accounted for.

3.2 Referees

The Referees shall:

3.2.1 have authority to intervene in competition at any stage to ensure that World Aquatics Rules are observed.

3.2.2 disqualify any competitor for any violation of the Rules that they personally observe.

3.3 Starter

3.3.1 The Starter shall start the race in accordance with III.4 following the signal by the Chief Referee.

3.4 Chief Timekeeper

The Chief Timekeeper shall:

3.4.1 assign at least two (2) Timekeepers to their positions for the start and finish.

3.4.2 ensure that a time check is made to allow all persons to synchronise their watches with the official running clocks 15 minutes before start time.

3.4.3 collect from each Timekeeper the time recorded for each competitor, and, if necessary, inspect their watches.

3.4.4 record or examine the official time for each competitor.

3.5 Timekeepers

Timekeepers shall:

3.5.1 take the time of each competitor/s assigned. The watches

must have memory and printout capability and shall be certified correct to the satisfaction of the Management Committee.

3.5.2 start their watches at the starting signal, and only stop their watches when instructed by the Chief Timekeeper.

3.5.3 promptly after each finish record the time of each competitor and turn it over to the Chief Timekeeper.

8 NOTE: When Automatic Officiating Equipment is used, the same complement of hand timers is to be used.

3.6 Chief Finish Judge

The Chief Finish Judge shall:

3.6.1 assign each Judge to a position.

3.6.2 record and communicate any decision received from the Referees during the competition.

3.6.3 collect after the race, signed results sheets from each Finish Judge and establish the result and placing which shall be sent directly to the Chief Referee.

3.6.4 confirm to each race judge their escort boat and instruct them in their duties.

3.6.5 collect after the race, signed sheets from each Judge of their observations during the race which shall be sent directly to the Chief Referee.

3.7 Finish Judges

Finish Judges (two) shall:

3.7.1 be positioned in line with the finish where they shall have at all times a clear view of the finish.

3.7.2 record after each finish the placing of the competitors according to the assignment given.

9 NOTE: Finish Judges shall not act as Timekeepers in the same event

3.8 Race Judge

Each Race Judge shall

3.8.1 be positioned in an escort safety craft (where applicable), assigned by random draw prior to the start, so as to be able to observe, at all times, their appointed competitor.

3.8.2 ensure at all times that the Rules of competition are complied with, violations being recorded in writing and reported to a Referee at the earliest opportunity.

3.8.3 have the power to order a competitor from the water upon expiry of any time limit so ordered by the Chief Referee.

3.8.4 ensure that their appointed competitor does not take unfair advantage or commit unsporting impediment on another competitor and if the situation requires instruct a competitor to maintain clearance from any other competitor.

3.9 Turn Judges

Turn Judges shall:

3.9.1 be positioned so as to ensure all competitors execute the alterations in course as indicated in the competition information documents and as given at the pre-race briefing.

3.9.2 record any infringement of the turn procedures on the record sheets provided, then immediately communicate the infringement to the Chief Referee.

3.9.3 promptly upon completion of the event deliver the signed record sheet to the Chief Referee

3.10 Feeding Platform Judge

3.10.1 Each Feeding Platform Judge shall be responsible for the management of the activity and the competitors authorised representatives present on the platform, in accordance with World Aquatics rules.

3.11 Relay Judge

3.11.1 The Relay Judge/s shall manage the activity on the Relay platform and change-over zone to ensure all changeovers occur in accordance with the rules whereby the arriving competitor completes their lap before the departure of the next competitor.

3.12 Safety Officer

The Safety Officer shall:

3.12.1 be responsible to the Chief Referee for all aspects of safety related to the conduct of the competition.

3.12.2 check that the entire course, with special regard to the start and finish areas, is safe, suitable, and free of any obstruction.

3.12.3 be responsible for ensuring that sufficient powered safety craft are available during the competition so as to provide full safety backup to the escort safety craft.

3.12.4 provide prior to the competitions to all competitors a tide/current chart clearly indicating the time of tide changes on the course and showing the effect of tides or current on a competitor's progress along the course.

3.12.5 in conjunction with the Medical Officer advise the Chief Referee if, in their opinion, conditions are unsuitable for staging the competition and make recommendations for the modification of the course or the manner in which the competition is conducted.

3.12.6 monitor temperature conditions periodically during the race.

3.13 Medical Officer

The Medical Officer shall:

3.13.1 be responsible to the Chief Referee for all medical aspects related to the competition and competitors.

3.13.2 inform the local medical facilities of the nature of the competition and ensure that any casualties can be evacuated to medical facilities at the earliest opportunity.

3.13.3 in conjunction with the Safety Officer, advise the Chief Referee if, in their opinion, conditions are unsuitable for staging the competition and make recommendations for the modification of the course or the manner in which the competition is conducted.

3.14 Course Officer

The Course Officer shall:

3.14.1 be responsible to the Management Committee for the correct survey of the course.

3.14.2 ensure the start and finish areas are correctly marked and all equipment has been correctly installed and, where applicable, is in working order.

3.14.3 ensure all course alteration points are correctly marked and manned prior to the commencement of the competition.

3.14.4 with the Referee and Safety Officer inspect the course and markings prior to the commencement of competition.

3.14.5 ensure that Turn Judges are in position prior to the start of the competition and report this to the Chief Referee.

3.15 Clerk of the Course

The Clerk of the Course shall:

3.15.1 assemble and prepare competitors prior to each event and ensure proper reception facilities at the finish are available for all competitors.

3.15.2 ensure each competitor is identified correctly with their race number and that all competitors have trimmed fingernails and toenails and are not wearing any jewellery, including watches.

3.15.3 be certain all competitors are present, in the assembly area, at the required time prior to the start.

3.15.4 keep competitors and officials informed of the time remaining before the start at suitable intervals until the last five minutes, during which one- minute warnings shall be given.

3.15.5 be responsible for ensuring that all clothing and equipment left in the start area is transported to the finish area and kept in safekeeping.

3.15.6 ensure that all competitors leaving the water at the finish have the basic equipment required for their well-being should their own attendants not be present at that time.

3.16 Recorder

3.16.1 The recorder shall record withdrawals from the competition, enter results on official forms, and maintain records for team awards as appropriate.

4. THE START

4.1 All Open Water competitions shall start with all competitors wearing an approved swim cap and standing on a fixed platform or in water depth sufficient for them to commence swimming on the start signal.

4.1.1 When starting from a fixed platform competitors shall be assigned a position on the platform, as determined by random draw.

4.1.2 For Olympic Games, World Aquatics Championships, and other World Aquatics competitions, the start shall be from a fixed platform.

4.2 The Clerk of the Course shall keep competitors and officials informed of the time before start at suitable intervals and at one-minute intervals for the last five minutes.

4.3 When the numbers of entries dictate the start shall be segregated into Men's and Women's competitions.

4.4 The start line shall be clearly defined by either overhead apparatus or by removable equipment at water level.

4.5 The Chief Referee shall indicate by a flag held upright and short blasts on a whistle when the start is imminent and indicate that the competition is under Starter's orders by pointing the flag at the starter.

4.6 The Starter shall be positioned so as to be clearly visible to all competitors.

4.6.1 On the Starter's command "take your marks" all competitors shall take up a starting position immediately in line with the start line where a platform is not used, or with at least one foot at the front of the platform.

4.6.2 The Starter will give the starting signal when he/she considers all competitors are ready.

4.7 The start signal shall be both audible and visual.

4.8 If in the opinion of the Chief Referee an unfair advantage has been gained at the start the offending competitor will be given a yellow or red flag in accordance with III.5.3.

4.9 All escort safety craft shall be stationed prior to the start so as not to interfere with any competitor, and if picking up their competitor

from behind shall navigate in such a way as not to manoeuvre through the field of competitors.

4.10 Although they may start together, in all other respects the men's and women's competitions shall be treated as separate events.

5. THE RACE

5.1 All Open Water competitions shall be Freestyle events and competitors are required to complete the whole course, respecting all designated turning buoys and course boundaries.

5.2 Race Judges shall instruct any competitor who is, in their opinion, taking unfair advantage by pacing or slip streaming with the escort craft to move clear.

5.3 Disqualification Procedure

5.3.1 If in the opinion of the Chief Referee or Referees, any competitor, or competitor's approved representative, or escort safety craft, takes advantage by committing any violation of the rules or by making intentional contact with any competitor, the following procedure shall apply:

5.3.1.1 1st Infringement:

A yellow flag and a card bearing the competitor's number shall be raised to indicate and to inform the competitor that she/he is in violation of the Rules.

5.3.1.2 2nd Infringement:

A red flag and a card bearing the competitor's number shall be raised by the Referee (III.3.1.6) to indicate and to inform the competitor that she/he is for the second time in violation of the Rules. The competitor shall be disqualified.

5.3.2 If in the opinion of a Referee, an action of a competitor or an escort safety craft, or a competitor's approved representative is deemed to be 'unsporting' the Referee shall disqualify the competitor concerned immediately. She/He must leave the water immediately and be placed in an escort craft and take no further part in the race.

5.4 Escort safety craft shall manoeuvre so as not to obstruct or place them directly ahead of any competitor and not take unfair advantage by pacing or slip streaming.

5.5 Escort safety craft shall attempt to maintain a constant position so as to station the competitor at, or forward of, the mid-point of the escort safety craft.

5.6 Standing on the bottom during a race shall not disqualify a competitor, but they may not walk or jump.

5.7 With the exception of Rule III.5.6 above competitor shall not receive support from any fixed or floating object and shall not intentionally touch or be touched by their escort safety craft or crew therein.

5.7.1 Rendering assistance by an official medical officer to a competitor in apparent distress should always supersede official rules of disqualification through “intentional contact” with a competitor (Rule III.5.3.1).

5.8 For races where escort boats are used, each escort safety craft shall contain: a Race Judge, a person of the competitor’s choice, and the minimum crew required to operate the escort safety craft.

5.8.1 Each escort safety craft shall display the competitor’s competition number so as to be easily seen from either side of the escort safety craft and the national flag of the competitor’s Federation.

5.9 Each safety craft shall contain appropriately qualified safety personnel and the minimum crew required to operate the safety craft.

5.10 No competitor shall be permitted to use or wear any device which may be an aid to their speed, endurance, or buoyancy. Approved swimsuit, goggles, a maximum of two (2) caps, nose clip and earplugs may be used.

5.11 Competitors shall be allowed to use grease or other such substances providing these are not, in the opinion of the Chief Referee, excessive.

5.12 The pacing of a competitor by another person entering the water is not permitted.

5.13 Coaching and the giving of instructions by the approved competitor’s representative on the feeding platform or in the escort safety craft is permitted. No whistle shall be allowed.

5.14 When taking sustenance, competitors may use Rule III.5.6 provided Rule III.5.7 is not infringed.

5.15 No objects can be thrown from the feeding platform to the competitors, including sustenance. The competitors shall receive their feeding directly from their representative by a feeding pole or by hand.

5.16 Feeding poles are not to exceed 5m in length when extended. No objects, rope or wire may hang off the end of feeding poles except national flags. National flags are allowed to be attached to the feeding pole but may not exceed the size of 30cm x 20 cm.

5.17 In all events, time limits shall apply as follows from the finish time of the first competitors:

- 15 minutes per 5km (or part thereof) up to a maximum time limit of 120 minutes.

5.17.1 Competitors who do not finish the course within the time limit shall be removed from the water except that the Chief Referee may allow a competitor outside the time limit to complete the course but not be eligible for any points or prizes.

5.18 Emergency Abandonment

5.18.1 In cases of emergency abandonment of races of 10 km or less, the race will be restarted from the beginning at the earliest possible moment.

5.18.2 In cases of emergency abandonment for any race longer than 10km, the final ranking will be as reported by the Chief Referee. If 2 hours of the race have not been completed, it will be restarted from the beginning at the earliest moment possible.

6. THE FINISH OF THE RACE

6.1 Escort safety craft should be stationed at the approach to and entrance of the finish lane to ensure that only the escort safety craft authorised to do so enter or cross this entrance.

The final places will be determined by the Chief Referee based upon the finish judges' report and the finish video tape.

6.2 It is mandatory for all competitors to wear a microchip transponder on each wrist throughout the race. If a competitor loses

a transponder the Race Judge or other authorised Official, will immediately inform the Chief Referee who will instruct the responsible Official on the water to issue a replacement transponder. Any competitor who finishes the race without at least one transponder will be disqualified.

6.3 When, at the finish of an Open Water Swimming competition, a vertical wall is available, competitors must touch the vertical wall to finish the race. Any competitor who does not touch the vertical wall will be disqualified.

6.4 The Finish Judges and Timekeepers shall be placed so as to be able to observe the finish at all times. The area in which they are stationed should be for their exclusive use.

6.5 Every effort should be made to ensure that the competitor's representative can get from the escort safety craft to meet the competitor as they leave the water.

6.6 Upon leaving the water some competitors may require assistance. Competitors should only be touched or handled if they clearly display a need, or ask for assistance.

6.7 A member of the medical team should inspect the competitors as they leave the water. A chair, in which the competitor can sit while an assessment is made, should be provided.

6.8 Once cleared by the medical member, competitors should be given access to refreshment.

7. SWIMWEAR & TECHNOLOGY

7.1 For open water swimming competitions with water temperature from 18°C and above, Swimsuits (men and women) shall not cover the neck, nor extend past the shoulder, nor extend below the ankle. Subject to these specific shape specifications, swimsuits for open water swimming competitions shall further comply with all other requirements applicable to swimsuits for swimming-pool competition.

7.2 From January 1, 2023, for open water swimming competitions in water with temperature below 18°C, the use of wetsuits is compulsory. Wetsuits are not permitted in open water swimming competitions in water with temperature 18°C and above.

7.3 Wetsuits

Wetsuits (for both men and women) shall completely cover torso, back, shoulders and knees. They shall not extend beyond the neck, wrists and ankles.

7.4 Team Event

All competitors from the same team must wear the same colour caps which shall also comply with the Competitions Rules I.8.

7.5 Technology

Technology such as drones, GPS tracking, bio-medical sensors or devices that record blood pressure, body temperature, stroke rate, breathing rate etc. via the transponder are permitted when approved by World Aquatics.

The technology may transmit such information but not act as a receiver giving information and advantage to the competitor such as "smart goggles", hearing devices, and the like.

8. OPEN WATER SWIMMING FACILITIES AND EQUIPMENT

8.1 Open Water Swimming Facilities

8.1.1 Start Platforms

Start Platforms shall be of sufficient size to allow 60cm space per competitor plus an additional 5m. Each competitor space should be identified and numbered with number 1 farthest from the entry to the platform. They shall be of sufficient width to allow for the necessary activities prior to the start and to support the weight of the competitors and officials at the start.

8.1.2 Finish

8.1.2.1 The final approach to the finish shall be clearly defined with markers of a distinctive colour and shall comprise the boundary of the course.

8.1.2.2 The area leading to the finish apparatus should be clearly marked by rows of buoys which narrow as they get closer to the finish wall.

8.1.2.3 The finish shall be clearly defined and marked by a vertical face.

8.1.2.4 The finish apparatus should, where possible, be a vertical wall at least 5 metres wide fixed if necessary to floatation devices, securely fastened in place so as not to be moved by wind, tide or the force of a competitor striking the wall. The finish should be filmed and recorded from each side and above by a video system with slow motion and recall facilities including timing equipment.

8.1.3 Turns / Alterations

8.1.3.1 All turns/alterations of the course shall be clearly indicated. Directional Buoys which are alterations of the course shall be of a different colour to guidance buoys. Wherever possible there shall be a long distance (to be approved by World Aquatics) from the start to the first turning buoy to ease congestion at the turn.

8.1.3.2 A clearly marked craft or platform, containing a Turn Judge, shall be positioned at all alterations of course in such a manner as not to obstruct a competitor's visibility of the turn.

8.1.4 Feeding Platforms

Feeding platforms shall be of sufficient size and buoyancy for the safe operation of the platform and the feeders and officials operating thereon. A minimum of 60cm of linear space per feeder plus 5m shall be required and of sufficient width to allow storage a preparation for competitor feeding. There needs to be sufficient space on one or more platforms to accommodate all feeders. Access to the platform shall be outside of the racecourse wherever possible.

8.1.5 All Platforms

All Starting Platforms, Feeding Platforms, Relay Platforms, turning apparatus and Turn Judges craft/platforms shall be securely fixed in position and not be subject to tidal, wind or other movements.

8.1.6 Water Conditions

8.1.6.1 A certificate of suitability for use of the venue shall be issued by the appropriate local health and safety authorities. In general terms the certification must relate to water purity and to physical safety from other considerations.

8.1.6.2 The minimum depth of water at any point on the course shall be 1.40 metre.

8.1.6.3 The water temperature should be a minimum of 16°C and a maximum of 31°C. It should be checked the day of the race, 2 hours before the start, in the middle of the course at a depth of 40 cm. This control should be done in the presence of a Commission made up of the following persons present: a Referee, a member of the Organising Committee and one coach from the teams present designated during the Technical Meeting.

8.2 Automatic officiating equipment for open water swimming

The operation of Automatic Officiating Equipment shall be under the supervision of appointed officials. Results recorded by Automatic Equipment shall be used to determine the winner, all placing and the time applicable to each competitor, The placing and times so determined shall have precedence over the decisions of judges & timekeepers. In the event that a break-down of the Automatic Equipment occurs or that it is clearly indicated that there has been a failure of the Equipment, or that a competitor has failed to activate the Equipment, the recordings of the judges & timekeepers shall be official.

8.2.1 Microchip Transponders

When Automatic Officiating Equipment is used for timing of competitions in accordance with Rule III.1.2, microchip transponder technology capable of providing split times is mandatory and should be added to the Equipment. Use of microchip transponder technology is mandatory for World Aquatics competitions, at the World Aquatics Championships and Olympic Games. Microchip transponder timing technology will be recorded officially in tenths of seconds.

8.2.2 Intermediate Timing Gate

Where an intermediate timing gate is used it shall be placed such that it becomes part of the overall course within the swimming line of the course without deviation for the competitors. It shall be a minimum width of 6m wide at the swimming waterline.

8.3 Automatic Officiating procedure for Open Water Swimming

8.3.1 Any timing device that is terminated by an official shall be considered a watch. Such manual times must be taken by three timekeepers appointed or approved by the Member in the country concerned. All watches shall be certified as accurate to the satisfaction of the governing body concerned. Manual timing shall be registered to 1/10 of a second. Where no Automatic Equipment is used, official manual times shall be determined as follows:

8.3.1.1 If two (2) of the three (3) watches record the same time and the third disagrees, the two identical times shall be the official time.

8.3.1.2 If all three (3) watches disagree, the watch recording the intermediate time shall be the official time.

8.3.1.3 With only two (2) out of three (3) watches working the average time shall be the official time. When this calculation results in a value that is expressed in hundredths of a second, the final digit shall be dropped without rounding.

8.3.2 When the Automatic Officiating Equipment fails to record the place and/or time of one or more competitors in a given race:

8.3.2.1 Record all available Automatic Officiating Equipment times and places,

8.3.2.2 Record all human times and places.

8.3.2.3 The official place will be determined as follows:

- A competitor with an Automatic Officiating Equipment time and/or place must retain his relative order when compared with the other competitors having an Automatic Officiating Equipment time and/or place within that race.
- A competitor not having an Automatic Officiating Equipment place shall have their place established by the Chief Referee from the video

recording of the finish of the race.

- A swimmer having neither an Automatic Officiating Equipment place nor an Automatic Officiating Equipment time shall establish their relative order by the place recorded by the judges.

8.4 Water Quality Guidelines for Open Water

8.4.1 Aims

The intention of this document is to provide guidance to the Local Organising Committee (LOC) of any World Aquatics open water swimming (OWS) event on matters relating to water quality at a proposed competition or training venue.

In adherence with WHO Guidelines on Recreational Water Quality (2021), these World Aquatics Guidelines provide the following details:

- Identification of significant water contaminants
- Levels of specified microorganisms
- A model for sanitary inspection
- A combined classification matrix to determine suitability of a competition venue

8.4.2 Background Narrative

World Aquatics (AQUA) hosts OWS events in the open sea, lakes, rivers and other inland waterways, commonly over distances of 5km, 10km and 25km. The Technical Open Water Swimming Committee (TOWSC) in collaboration with the Sports Medicine Committee (SMC) works to ensure athlete safety as their priority.

While OWS Rules address a number of health and safety factors including water temperature, water quality and other forms of contamination or water hazard, these Guidelines specifically address water quality, with particular focus on the bacterial indicator organisms, intestinal Enterococci and Escherichia Coli (E.coli). These are reliable indicators of faecal contamination from animals, human sewage, or effluent and present the likeliest risk to athlete welfare.

Open-water swimmers may be exposed to contamination from waterborne agents through inhalation, ingestion (swallowing) and by

direct skin contact. Sensitive mucosal linings of the eyes, ears, nose, mouth and upper respiratory tract are potential infection entry points during prolonged immersion.

Swallowing a significant volume of contaminated water will challenge the gastrointestinal system and may cause diarrhoea and vomiting. However, these effects are determined primarily by the strain and concentration of a specific microorganism, the period of exposure and the immune status or susceptibility of the host (the swimmer).

Consequences may range from mild to moderate gastrointestinal symptoms, ear, nose and eye infections, and in some susceptible individuals, respiratory illness. In most cases however, symptoms are transient and respond to conservative medical management. However, more serious medical consequences may arise and therefore a competition venue meeting accepted safety standards will clearly minimise risks to the athlete.

The suitability of a potential venue for training or competition is determined by a combined microbial water quality assessment and survey of sanitation. The former quantifies identified bacteria while the latter involves visual inspection, identifying other pollution sources such as runoff from stormwater drains or industrial outflows. The sanitary survey also considers the influence of weather patterns, particularly rainfall, and potential effect on a venue.

8.4.3 Assessment of Bacterial Contaminants

Universal agreement has determined intestinal Enterococci and *E. coli* as the most reliable indicators of faecal contamination in water. Acceptable levels of these organisms for safe swimming are in accordance with limits proposed by the WHO (2021), the United States Environmental Protection Agency (2017), the European Environmental Agency (2020), the New Zealand Ministry of Health (2021) and the Australian National Health and Research Council (2017).

Therefore, World Aquatics proposes the following standards at OWS venues with a distinction between tidal waters and inland waterways that account for variabilities such as salinity, tidal influence, and distribution of organisms:

cfu = colony forming unit

| | Excellent water quality | Good water quality | Unacceptable water quality |
|------------------------------------|------------------------------------|-------------------------------|---------------------------------------|
| Enterococci (cfu/100mL) | <100 | <200 | >200 |
| E coli (cfu/100mL) | <250 | <500 | >500 |

Table 1. Bacterial levels for sea and transitional (tidal) waters

| | Excellent water quality | Good water quality | Unacceptable water quality |
|------------------------------------|------------------------------------|-------------------------------|---------------------------------------|
| Enterococci (cfu/100mL) | <200 | <400 | >400 |
| E coli (cfu/100mL) | <500 | <1000 | >1000 |

Table 2. Bacterial levels for inland waterways

8.4.4 Frequency of water analysis

To be awarded an OWS event, the Local Organising Committee (LOC) is obligated to provide the World Aquatics Office with an authorised water quality analysis report from venue samples collected at the site and then again at the following intervals:

- Two (2) months from competition
- Seven (7) days prior to start of competition
- No more than 48hrs prior to competition
- Day of competition*

Water samples must be collected from three (3) different locations

on the course and analysed at an authorised laboratory. The poorest result should determine the overall water quality with the following tolerance levels for respective venues.

**NOTE: Day of competition sampling, notwithstanding delayed reporting, will only be used when a change in water quality, caused by storms or other unpredictable factors, needs to be considered in the advent of illness amongst participants. Data from water analysis will guide appropriate treatment.*

8.4.4.1 For ocean and transitional (tidal) waters

- pH between 6 - 9
- Enterococci not more than 100cfu/100mL
- E.coli not more than 250cfu/100mL
- Absence of algal bloom

8.4.4.2 For inland waterways

- pH between 6 - 9
- Enterococci not more than 200cfu/100mL
- E.coli not more than 500cfu/100mL
- Presence of algal bloom and scum formation in inland waterways will necessitate a test for cyanobacteria with results to be confirmed by the appropriate local health authority. A tolerance of less than 100,000 cells/mL is required by World Aquatics.

(Reference: World Triathlon Water Quality Statement 2019)

8.4.5 Sanitary Inspections

A venue sanitary inspection is primarily a “subjective” visual survey, best undertaken by qualified personnel.

This inspection indicates whether the competition venue is potentially susceptible to faecal contamination from other sources. These include inflow identified by local health authorities, from nearby factories, farms, or hotels, as well as the influence of stormwater overflow after periods of heavy rainfall.

In addition, a visual inspection should record areas of stagnation, water clarity, odour, evidence of algal bloom, surface “scum” or visible pollutants such as oil film or “slick.” These constitute a “checklist” of sanitary factors to be included by the potential host organisation in their bid document to World Aquatics.

Where there is demonstrable impact from weather events such as heavy rainfall, the bid document should provide clear, documented evidence of water “clearance time” to return the venue to acceptable levels of indicator organisms.

In addition, a visual survey of every venue must also identify potential hazards such tides, currents, general debris, floating logs or rocky outcrops that could affect the laying of a course or impede or injure a swimmer. These matters overlap the brief of the AQUA Safety Officer, whose inspection takes place at the time of competition.

| Sanitary Inspection Factors | Excellent Sanitation | Good Sanitation | Poor Sanitation |
|------------------------------------|-----------------------------|------------------------|------------------------|
| Algal bloom | absent | absent | present |
| Surface contaminants (eg oil) | absent | absent | present |
| Water clarity | Visibility to 50 cm | cloudy | cloudy |
| Odour | absent | moderate | present |
| Weather effects | nil | present but reducing | present |
| Active aquatic life | present | present | absent |

Table 3. Sanitary Inspection Checklist

8.4.6 Classification Matrix for Venue Suitability

In meeting obligations to athlete health and safety, the suitability of every World Aquatics OWS venue must be determined by considering three data sets, namely:

1. Results of water quality analysis
2. Report from sanitary inspection
3. Knowledge of local weather impact

Consequently, a matrix of classification, modelled on the World Triathlon Water Quality Statement (2019), is proposed by World Aquatics to assist in determining the suitability of all OWS competition venues.

8.4.6.1 Water Quality Decision Matrix for Sea/Ocean and Transitional (tidal) Waters

| | | 2 past results E. coli <250 enterococci <100 | Last result E. coli 250- 500 enterococci 100-200 | 2 past results E. coli 250 - 500 enterococci 100-200 | last result E. coli >500 enterococci >200 |
|--------------------------|------------------|---|--|--|--|
| Sanitary Category | excellent | 1 | 2 | 2 | 4 |
| | good | 1 | 2 | 3 | 4 |
| | poor | 2 | 3 | 3 | 4 |

Table 4 Water Quality Decision Matrix for Sea/Ocean and Transitional (tidal) Waters

8.4.6.2 Key for Venue Suitability in Transitional Waters

| | |
|----------|---|
| 1 | <p>Excellent water quality:</p> <p>E.coli <250cfu/100mL or Enterococci <100cfu/100mL with excellent/good sanitary inspection and no forecasted heavy rainfall.</p> |
| 2 | <p>Good water quality:</p> <p>E.coli <250cfu/100mL or Enterococci <100cfu/mL with some deficiencies in sanitary inspection or forecasted heavy rainfall.</p> <p>OR E.coli 250-500cfu/100mL or Enterococci 100-200cfu/mL with no deficiencies in sanitary inspection or no forecasted heavy rainfall.</p> |

| | |
|----------|---|
| 3 | Fair water quality: E.coli 250-500cfu/100mL, Enterococci 100-200cfu/100mL with poor sanitary inspection and/or forecasted heavy rainfall. |
| 4 | Poor water quality: E.coli >500cfu/100mL, Enterococci >200cfu/100mL with poor sanitary inspection and/or forecasted heavy rainfall. |

Table 5 Key for Venue Suitability in Transitional Waters

8.4.6.3 Water Quality Decision Matrix for Inland Waterways

| | | 2 past results E. coli <500 enterococci <200 | Last result E. coli 500-1000 enterococci 200-400 | 2 past results E. coli 500 - 1000 enterococci 200-400 | last result E. coli >1000 enterococci >400 |
|--------------------------|------------------|--|--|---|--|
| Sanitary Category | excellent | 1 | 2 | 2 | 4 |
| | good | 1 | 2 | 3 | 4 |
| | poor | 2 | 3 | 3 | 4 |

Table 6 Water Quality Decision Matrix for Inland Waterways

8.4.6.4 Key for Venue Suitability for Inland Waterways

| | |
|----------|---|
| 1 | Excellent water quality: E.coli <500cfu/100mL or Enterococci <200cfu/100mL with excellent/good sanitary inspection and no forecasted heavy rainfall. |
| 2 | Good water quality: E.coli <500cfu/100mL or Enterococci <200cfu/mL with some deficiencies in sanitary inspection or forecasted heavy rainfall. OR E.coli 500-1000cfu/100mL or Enterococci 200-400cfu/mL with no deficiencies in sanitary inspection or no forecasted heavy rainfall. |
| 3 | Fair water quality: E.coli 500-1000cfu/100mL, Enterococci 200-400cfu/100mL with poor sanitary inspection and/or forecasted heavy rainfall. |
| 4 | Poor water quality: E.coli >1000cfu/100mL, Enterococci >400cfu/100mL with poor sanitary inspection and/or forecasted heavy rainfall |

Table 7 Key for Venue Suitability for Inland Waterways

8.4.7 Explanatory Note

From the above Water Quality Decision Matrices, World Aquatics expects all OWS competition venues to meet the criteria outlined in **Level 1, as Excellent water quality.**

However, there will be circumstances where **Level 2 (Good water quality)** may also be considered acceptably safe for competition. As examples, a venue may be considered unsuitable only after heavy rainfall and reclassified satisfactory after water “clearance” or where deficiencies in sanitation such as the presence of debris, hazards or surface contaminants are physically cleared.

All decisions on venue reclassification reside with the joint Commissions of the TOWSC and SMC, or their appointee, in collaboration with the LOC Medical Officer.

NOTE: Water Levels 3 and 4 are unacceptable to World Aquatics for safe competition or training.

ACKNOWLEDGEMENT: Special acknowledgement is made of the World Triathlon Water Quality Statement (2019) and the contributions of Sergio Migliorini and Thanos Nikopoulos to their Water Quality Matrix upon which the World Aquatics Water Quality Decision Matrices are based.

REFERENCES

- *Hall V, Taye A, Walsh B, et al. 2017. A large outbreak of gastrointestinal illness at an open-water swimming event in the River Thames, London. *Epidemiology and Infection* 145: 1246-1255.*
- *Joosten R, Sonder G, Parkkali S, et al. 2017. Risk factors in gastroenteritis associated with canal swimming in two cities in the Netherlands during the summer of 2015: a prospective study. *PloS One* 12: e0174732.*
- *WHO Guidelines on Recreational Water Quality. Volume 1: coastal and fresh waters. Geneva: World Health Organisation; 2021. Licence: CC BY-NC-SA 3.0 IGO.*
- *Cabelli VJ, Dufour AP, McCabe LJ, et al. 1982. Swimming associated gastroenteritis and water quality. *Amer J Epidemiology* 115:606-616.*
- *New Zealand Ministry of Health. 2021. ESR Recreational Water Quality Guidelines Update. Wellington.*
- *European Environment Agency. 2020. State of bathing water. <https://www.eea.europa.eu/themes/water/Europes-seas-and-coasts/assessments/state-of-bathing-water-3>.*
- *United States Environmental Protection Agency. 2013. Beach sanitary surveys. <http://www.epa.gov/beach-tech/beach-sanitary-surveys>.*
- *National Health and Medical Research Council. 2017. Guidelines for managing risks in recreational water. Canberra.*

- *USEPA. 2017. Five-year review of 2012 recreational water quality criteria. Washington DC: United States Environmental Protection Agency. EPA 823 R 18 001.*
- *Migliorini, S. 2019. World Triathlon Water Quality Statement.*

9. IDENTIFICATION OF COMPETITORS DURING THE RACE

9.1 Numbering of competitors

The numbering of Competitors is to appear on the arms, upper backs and hands of competitors. On the arms the numbers shall be arranged vertically. On the upper backs and hands the numbering is horizontally. Where the numbering of the arms and backs is made with an ink template: 100 mm high x 60 mm wide. The numbering of the hands of competitors is allowed by marking pens. For Competitors with darker skin and full body wet suits a white marker pen will be required.

10. Open Water Safety Regulations

10.1 General Concept

10.1.1 These regulations shall apply to all open water events of a distance of 5km or greater organized by World Aquatics, sanctioned by World Aquatics, or over which World Aquatics has technical control ("Covered Competitions"). These regulations shall augment and supersede as applicable, the existing regulations established for specific events.

10.1.2 Critical elements of these regulations include:

- Submission of a site-specific Safety Plan compliant with these regulations as part of the event approval process;
- Approval of the Safety Plan by the AQUA Safety Delegate and by the AQUA Medical Delegate as a condition of event approval;
- The World Aquatics Safety Delegate and the Medical Delegate should see both plans in advance and work together to ensure both plans mesh where required.
- Appointment of an AQUA Safety Delegate who is independent of the Host Member Federation and Organizing

Committee ("HMF/OC") to ensure that the approved safety plan and the requirements of these regulations are implemented on race day;

- Authority vested in anyone of the AQUA Safety Delegate, the HMF/OC Safety Officer, Medical Officer, or the Chief Referee to postpone, cancel, or modify an event where safety conditions warrant;
- Careful accounting for all swimmers before, during and after the race to ensure that all swimmers starting the race are accounted for at the time they withdraw or finish the race;
- All swimmers must be observed during the race so that there is immediate recognition when a swimmer is struggling or loses consciousness.
- There must be immediate rescue available when a swimmer is in distress; and
- There must be immediate resuscitation available to address medical emergencies.

10.2 Submission of a safety plan to World Aquatics

10.2.1 For all Covered Competitions, the HMF/OC for the competition shall submit a site-specific safety plan to World Aquatics for World Aquatics' approval. That safety plan shall comply with all requirements of these regulations.

10.2.2 Each safety plan shall be reviewed by the AQUA TOWSC Safety Delegate, who shall approve, modify, or reject the submitted safety plan.

10.2.3 No Covered Competition subject to these regulations shall be sanctioned or approved by World Aquatics without an approved safety plan in place.

10.2.4 Any change to an approved safety plan requested up until five days before the race must be approved by the AQUA TOWSC Safety Delegate as provided in III.10.2.2 above. Changes to an approved safety plan necessitated by circumstances beyond the control of the HMF/OC requested within five days of the race, or otherwise required to protect participant safety, may be approved by

the AQUA Safety Delegate appointed by World Aquatics for the race.

10.3. Implementation of the Safety Plan at the Event

10.3.1 Concurrently with the awarding of an event, World Aquatics shall appoint an AQUA Safety Delegate for each Covered Competition. The AQUA Safety Delegate shall be independent of the HMF/OC. The AQUA Safety Delegate shall be generally responsible for all matters pertaining to the safety of the competition participants and shall be specifically responsible for ensuring that the approved safety plan and these regulations are followed during the competition.

10.3.2 The HMF/OC shall appoint an HMF/OC Safety Officer with experience in open water safety and an HMF/OC Safety Committee responsible for organizing and implementing all safety aspects of the competition. The HMF/OC Safety Committee shall include certified local lifeguards with experience in open bodies of water who shall be involved in safety during the competition.

10.3.3 The AQUA Safety Delegate shall inspect the competition venue and meet with the HMF/OC Safety Officer and Safety Committee at least three days prior to the scheduled start of the competition to ensure that the safety plan remains adequate to address the conditions at the competition venue and that all actions necessary to implement the approved safety plan have been taken.

10.3.4 The AQUA Safety Delegate shall have authority to modify, postpone, or cancel the competition whenever the approved safety plan is not being implemented or as otherwise required to protect the safety of participants. The HMF/OC Safety Officer, Medical Officer and the Chief Referee of the race may advise the AQUA Safety Delegate on the modification, postponement or cancellation of the competition.

10.4 Specific Safety Plans and Race Safety Implementation Requirements

Each safety plan required by these regulations shall include the following minimum requirements. The implementation of these requirements is mandatory for each Covered Competition.

10.4.1 Technical Meeting

(a) Athlete representatives must attend the Technical Meeting. If a swimmer or the swimmer's representative is unable to attend the Technical Meeting, the swimmer must attend a special safety briefing in order to participate in the race.

(b) Safety topics that shall be included in the Technical Meeting include:

- explanation of the course layout and hazards
- tides, currents or other water conditions
- marine life
- weather conditions
- water temperature
- water quality conditions
- description of the method by which the Safety Committee will monitor swimmers
- location of safety craft
- description of medical support onsite and availability of hospital care
- signal for help-float on back and raise hand for assistance
- evacuation plan for clearing the racecourse, including description of related visual and audible signals

(c) A short pre-race safety briefing, mandatory for all swimmers, shall be held immediately prior to the race.

10.4.2 Monitoring And Rescue Of Swimmers

(a) Each swimmer shall be under the direct observation of at least one HMF/OC Safety Committee member or Referee at all times during the race. The configuration of the course will determine where Safety Committee observers are positioned to observe swimmers. For example, in an open racecourse with no physical restraints, and depending on the size of the field, it is ideal to have an escort craft with a designated observer assigned to assure that each swimmer is monitored. However, in a competition conducted in a narrow rowing basin, it would be impractical to have individual escort craft on the racecourse, rather, HMF/OC Safety Committee observers may be able to follow the swimmers by walking along the shore. In other circumstances, it may be desirable to organize the HMF/OC Safety Committee observers by zone.

Whenever possible, given the layout of the racecourse, HMF/OC Safety Committee observer craft (boats or kayaks) should guarantee that all swimmers separated from the lead group or lead swimmer can be followed directly by a safety boat or kayak. The safety craft must follow the swimmer or group of swimmers at a reasonable

distance so as to allow immediate intervention if a safety action is required.

(b) There must be sufficient safety craft or escort craft located on the course to immediately recognize when a swimmer is in distress and to initiate an immediate rescue response after observation or notification that a swimmer's rescue is required. In most course configurations, there should also be stationary safety craft located every 400 meters along the course, with a CPR- and life support-trained responder on board. To accomplish this, there must be sufficient designated rescue landing points along the course and sufficient CPR- and life support-trained personnel in proximity to each swimmer or group of swimmers.

10.4.3 Safety Communication

(a) The AQUA Safety Delegate and the HMF/OC Safety Officer must have instant two- way communication access with: each other; all members of the HMF/OC Safety Committee assigned to observe swimmers; all safety craft; personnel on each feeding platform; the HMF/OC Chief Medical Officer; the Chief Referee; and other course officials. The line of command shall be as follows: the AQUA Safety Delegate deals directly with the HMF/OC Safety officer and the HMF/OC Safety Officer deals directly and shall have the absolute power to mobilize all lifeguards and medical personnel when required.

(b) Safety Committee members assigned to monitor swimmers must also be able to instantly communicate with all safety craft.

(c) Two-way radios or other communication equipment with one channel or number reserved for emergencies are required, and a backup system shall also be available.

10.4.4 Accounting for Swimmers

(a) Each swimmer shall have his or her race number marked clearly on his or her body. The Clerk of the Course is responsible for the accountability of all competitors from the start of the race until the last competitor has safely completed the race. As swimmers withdraw from or finish the race, the Clerk of the Course shall check off each swimmer from the list of swimmers who started the race.

(b) No swimmer shall exit the race through withdrawal,

disqualification, completion, or otherwise-without checking in with the Clerk of the Course.

(c) All swimmers should wear when available whatever electronic tracking technology may be required as part of the approved safety plan.

10.4.5 Feeding Stations

(a) For Covered Competitions greater than five kilometers, a floating or stationary feeding station should be available at least every 2.5 kilometers.

10.4.6 Local Suitability Certificate, Including Water Quality

(a) The course shall be in water that is subject to only minor currents or tides and shall be free of hazardous obstacles, pollutants, and dangerous marine life.

(b) A certificate of suitability for the use of the venue shall be issued as per III.8.1.6.1 above. The certificate provided in connection with plan approval shall be updated within seventy-two hours of the day of the race.

10.4.7 Water Temperature

(a) The water temperature shall be measured before the race as per III.8.1.6.3 above.

(b) The water temperature shall be monitored as provided above at one-hour intervals during the race. If the water temperature drops below 16°C or exceeds 31°C at any of the measuring intervals, the water temperature shall be measured again in 30 minutes and if that measurement is also below 16°C or exceeds 31°C, the race must be stopped until such time as the water temperature complies with this rule.

10.4.8 Medical Service

(a) The HMF/OC shall appoint as its Chief Medical Officer a physician with experience in providing medical care during endurance events. Other members of the HMF/OC medical team shall include sufficient individuals with emergency medical training (basic life support and CPR) to staff the stationary safety boats and venue medical facility.

(b) The onsite medical facility shall include basic emergency and trauma equipment, AED, and any heating or cooling facilities required by the approved safety plan.

(c) An ambulance shall be available onsite or on call within five minutes of the venue. It is recommended that a back-up ambulance shall also be available onsite or on call within 15 minutes of the venue.

(d) Where the travel time by ambulance between the venue and the nearest hospital with emergency room facilities is longer than one hour, then the safety plan shall require provision for helicopter transport.

10.4.9 Safety During Training. Pre-Race Warm Up And Post-Race Warm Down

(a) The HMF/OC must provide safety monitoring on the course during established training hours. No swimmer shall be allowed to enter the racecourse during training without an escort craft. Monitoring of swimmers by HMF/OC Safety Committee observers should also occur during pre-race warmups and post-race warm downs.

10.4.10 Course Evacuation Plan

(a) Each safety plan must include a course evacuation plan to expeditiously get all swimmers and race personnel off the water and to safety in emergency situations.

11. ANNEXES

11.1 Annex 1 – Diagram – Field of Play

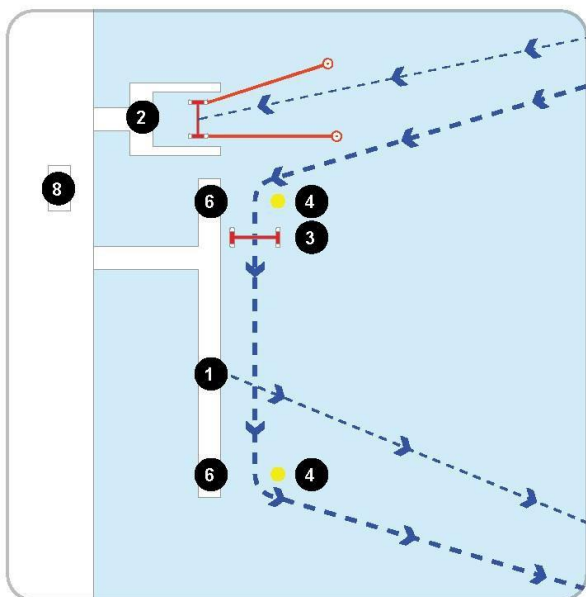
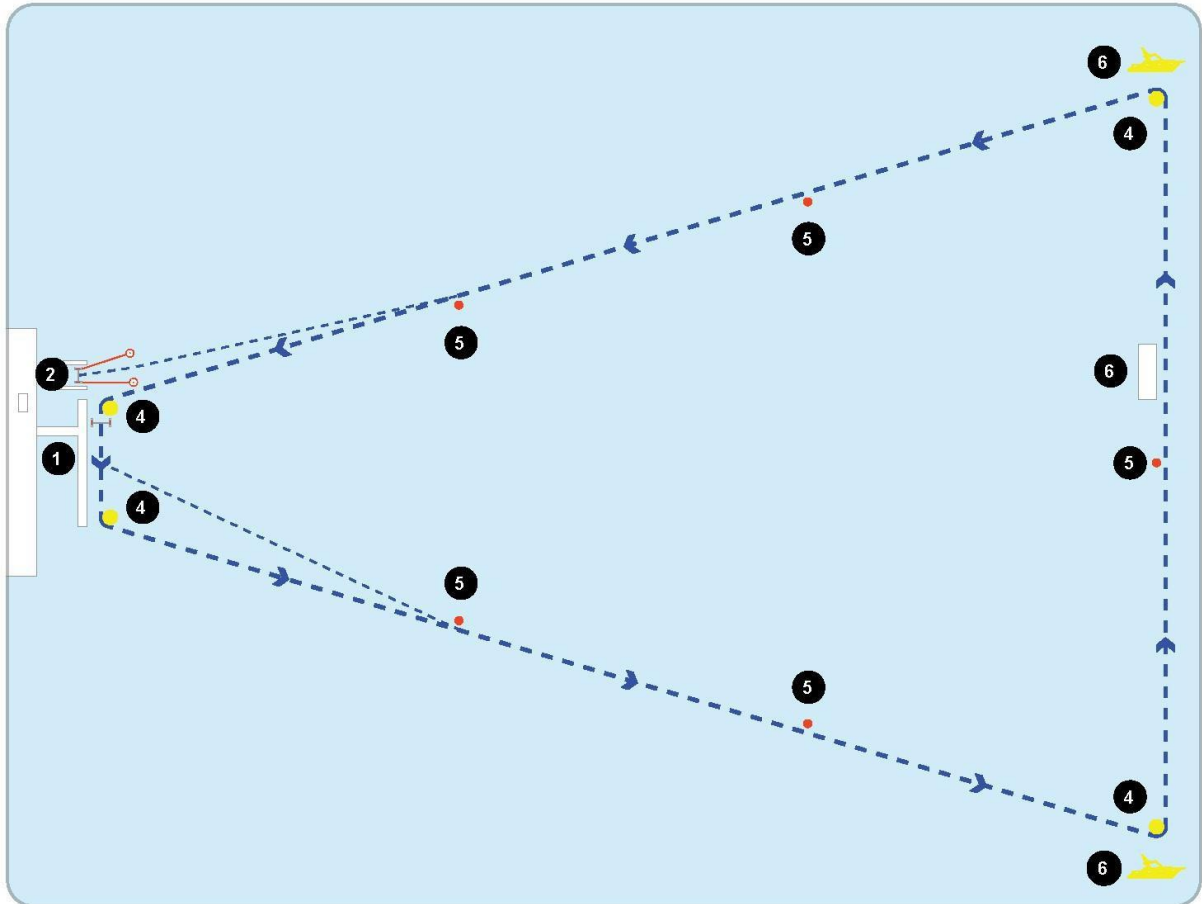

- | | |
|--------------------------------|--------------------|
| 1 Start Platform | 7 Feeding Platform |
| 2 Finish Gate | 8 Timing Room |
| 3 Intermediate Gate | |
| 4 Directional Buoy | |
| 5 Guidance Buoy | |
| 6 Turn Judge platform or craft | |

Water Conditions

- The course shall be in water that is subject to only minor currents or tide and may be salt or fresh water.
- The minimum depth of water at any point on the course shall be 1.40 meter
- The water temperature should be a minimum of 16°C and a maximum of 31°C. It should be checked the day of the race, 2 hours before the start, in the middle of the course at a depth of 40 cm. This control should be done in the presence of a Commission.

11.2 Annex 2 – Diagram – Crafts Position

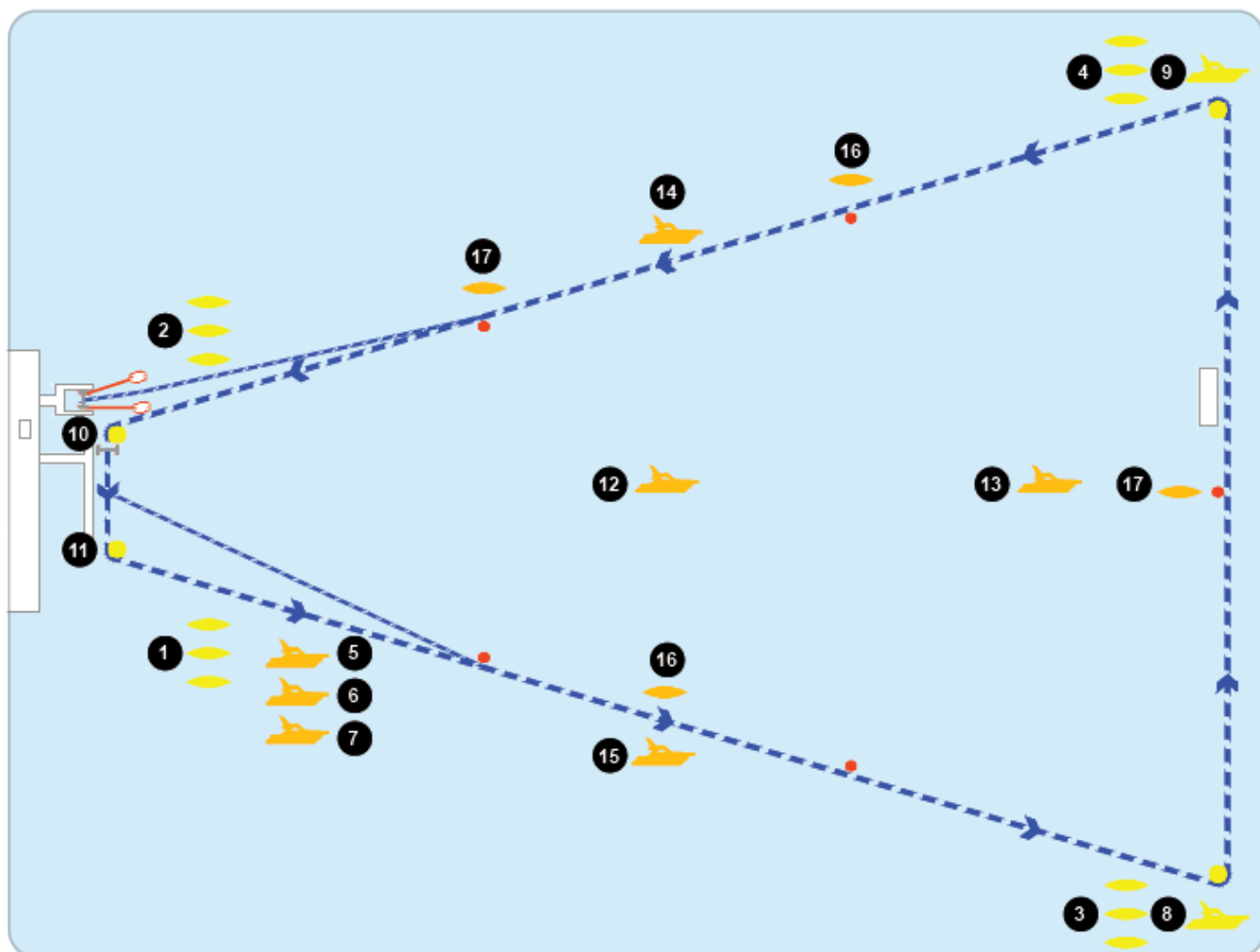

Operational Plan - Crafts position

- | | |
|--------------------------------------|--|
| 1 Kayak - Left side of the pontoon | 12 Boat - Course Officer |
| 2 Kayak - Right side of the pontoon | 13 Boat - Medical Officer + 1 Driver + 1 Lifeguard |
| 3 Kayak - Right side of Turn 1 | 14 Boat - Safety Officer + 1 Driver + 1 Lifeguard |
| 4 Kayak - Left side of Turn 2 | 15 Boat - Media + 1 Driver |
| 5 Boat - Chief referee 1 + 1 Driver | 16 Jetski - 1 Paramedic + 1 Driver |
| 6 Boat - Referee 1 + 1 Driver | 17 Jetski - 1 Paramedic + 1 Driver |
| 7 Boat - Referee 2 + 1 Driver | |
| 8 Platform or Craft* - Turn Judge 1 | |
| 9 Platform or Craft* - Turn Judge 2 | |
| 10 Platform or Craft* - Turn Judge 3 | |
| 11 Platform or Craft* - Turn Judge 4 | |

*Craft requires a driver

11.3 Annex 3 – Diagram – Platforms and Buoys

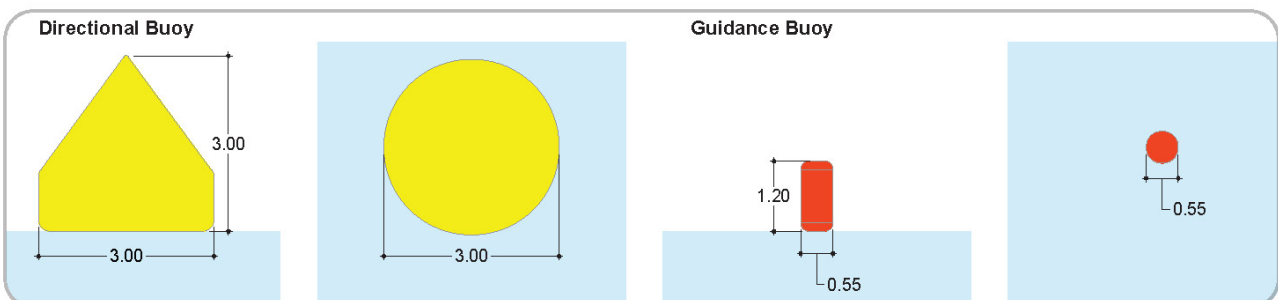
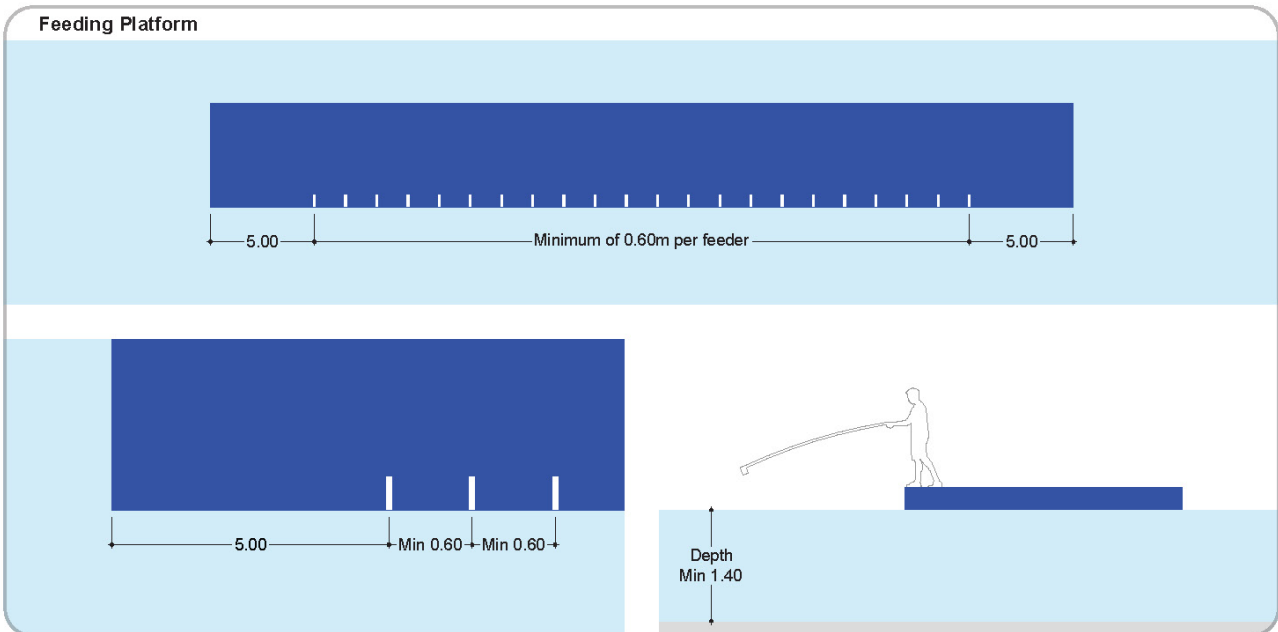
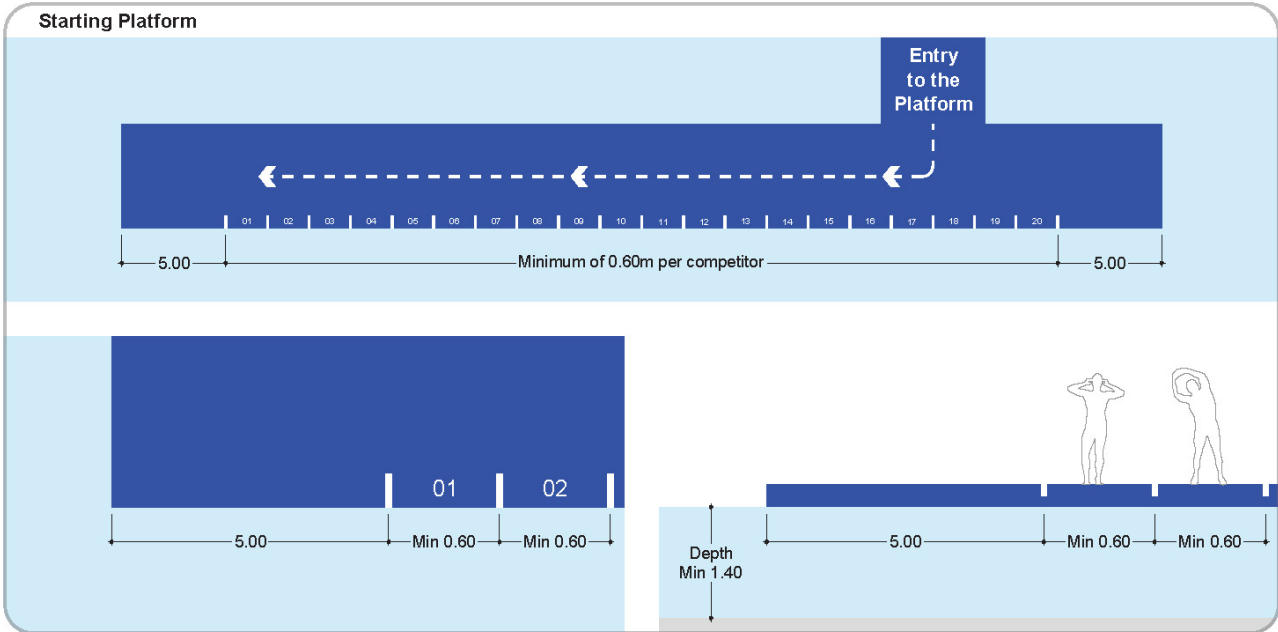

11.4 Annex 4 – Diagram - Gates

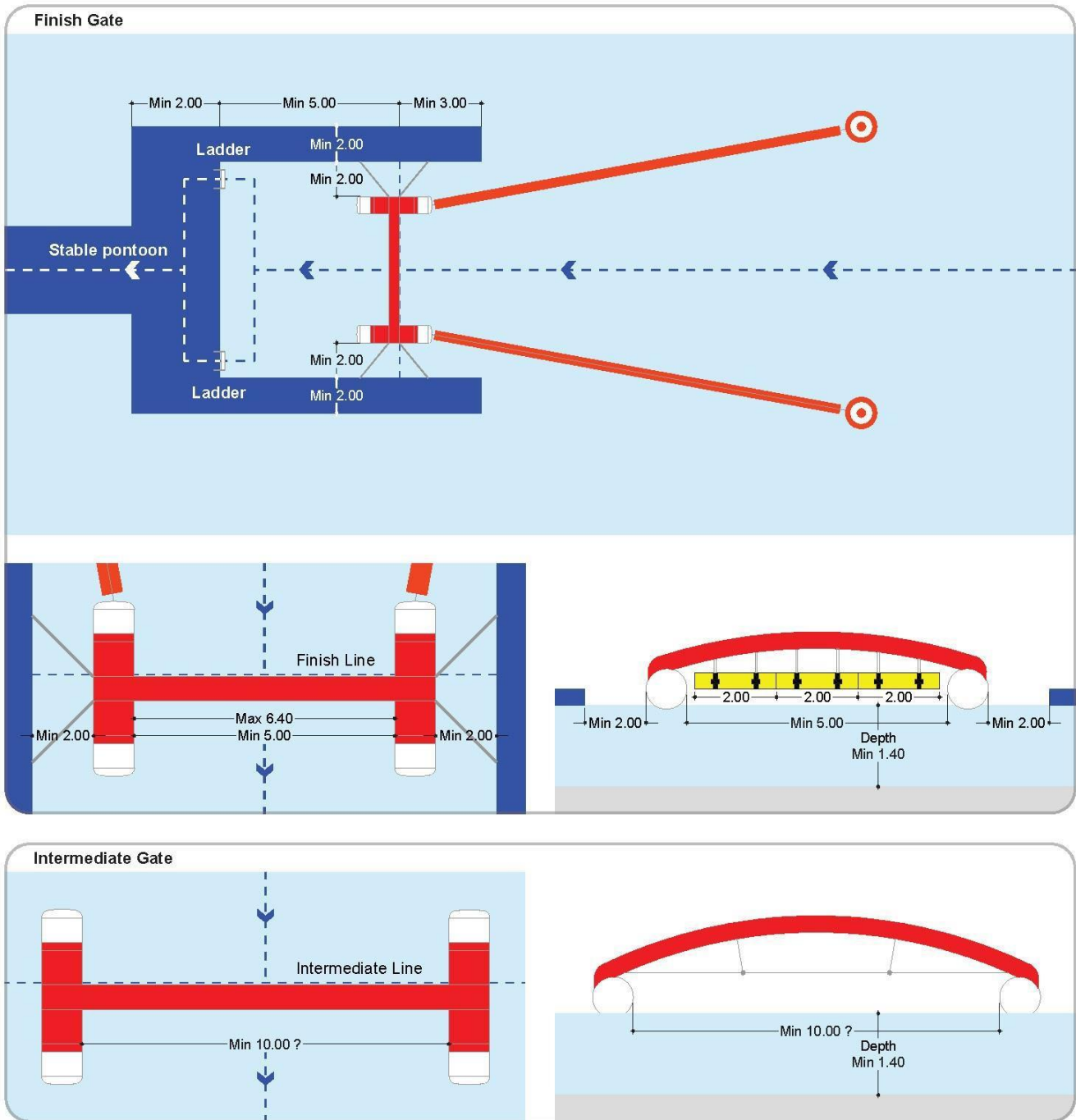

11.5 Annex 5 – Diagram – Timing Room

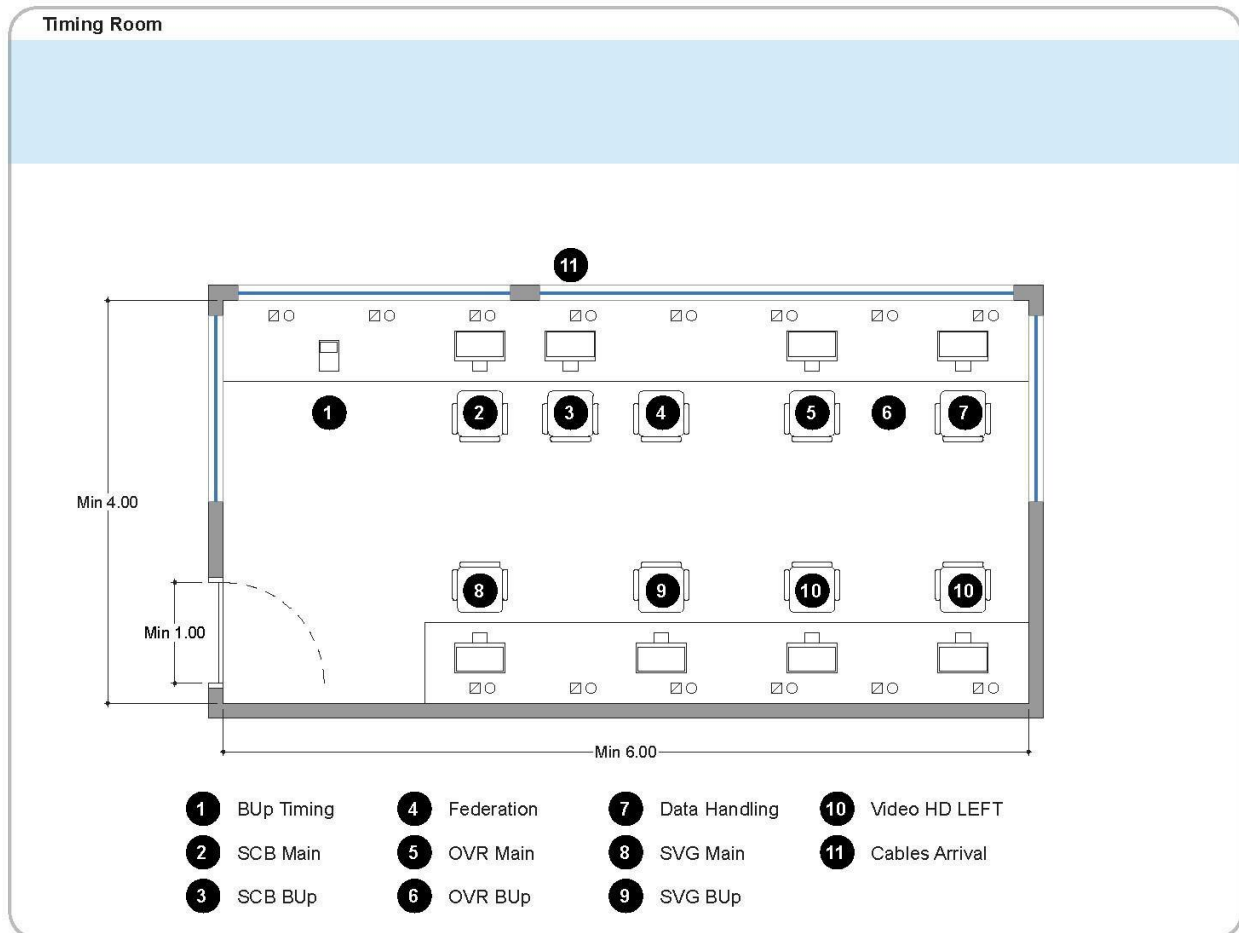

General Requirements

- Wireless transmitting devices that are not part of Timing/ Judging equipment are not allowed around the finish area.
- The athletes must wear the microchip with the provided wristband. No modification on the wristband is allowed.
- At the finish, the Chief Referee must go to the Timing room for video judging as soon as possible.
- Timing room must have good visibility on the finish gate. The maximum distance between the finish and the Timing Room shall be 40m.

Requirements to be provided by OC

- Rainproof room
- Air Conditioning 18-20°C. Air Conditioning must be adjusted for about 10 people and the equipment.
- Minimum room area: 25m²
- Minimum room height: 2.20m
- Power: Each socket 208-240V / 50-60Hz / 2kVA
- View to the FOP
- High speed internet connection
- TV/ Monitor
- Cables arrival hole
- Tables (Height: Min 70cm, Width: Min 80cm)
- Chairs

PART FOUR: DIVING RULES

1. GENERAL

1.1 These Rules shall govern all Diving competitions, including Olympic Games, World Aquatics Championships, Diving World Cup, and World Aquatics Junior Championships.

1.2 All diving installations, including the springboards and platforms, shall be in accordance with the World Aquatics Diving Facilities Rules, inspected and approved by the delegate of World Aquatics no later than 120 days prior to the start of the competitions.

1.3 When diving is sharing the same venue with any other discipline, all diving installations shall be available for use by entered diving competitors on competition days provided no competition is in progress.

1.4 Divers younger than 14 years on December 31st in the year of the competition shall not be permitted to compete at the Olympic Games, World Aquatics Championships or Diving World Cups.

1.5 Diving Number Designations

1.5.1 All dives shall be designated by a system of 3 or 4 numerals followed by a single letter.

1.5.2 The first digit shall indicate the group to which the dive belongs:

1 = Front

2 = Back

3 = Reverse

4 = Inward

5 = Twisting

6 = Armstand

1.5.3 In the Front, Back, Reverse and Inward groups, a 1 in the second digit indicates that the dive has a flying action during the dive. When there is no flying action the second digit shall be 0.

1.5.4 The third digit shall indicate the number of half somersaults being performed. For example 1 = ½ somersault, 9 = 4 ½ somersaults, etc. When there are more than 4 ½ somersaults there will be four digits with the third and fourth digits indicating the number of half somersaults. For example 11 = 5 ½ somersaults as 1011.

1.5.5 In Armstand dives the second digit indicates the group or direction to which the dive belongs:

1 = Front

2 = Back

3 = Reverse

1.5.6 In the Twisting group (those dives beginning with the digit 5) the second digit indicates the group or direction of the take-off as listed in IV.1.5.2 above.

1.5.7 In the Twisting and Armstand groups the fourth digit shall indicate the number of half twists being performed.

1.5.8 The letter at the end of the dive number shall indicate the position in which the dive is performed:

A =Straight

B = Pike

C =Tuck

D = Free

1.5.9 Free position means any combination of the other positions and is restricted in its use in some twisting dives.

1.6 Degree of Difficulty

1.6.1 The degree of difficulty of each dive is calculated using the following formula (the component values of the formula are outlined in IV.14.1 (Appendix 8) and IV.14.3 (Appendix 10)):

A + B + C + D + E = DEGREE OF DIFFICULTY

1.6.2 As a guide, dives with their numbers and degrees of difficulty for springboard dives have been calculated and are tabled in IV.14.2 (Appendix 9). Platform dives are tabled in IV.14.4 (Appendix 11).

1.6.3 Any dive, which is not tabled in Appendix 9 or 11 but is used in a competition, shall be given the dive number and degree of difficulty as determined in accordance with Rules IV.1.5 and IV. 1.6.

1.6.4 In calculating the degree of difficulty for dives with twists, the following need to be noted:

- Dives with $\frac{1}{2}$ somersault and twists can only be executed in position A,B or C,
- Dives with 1 or $1 \frac{1}{2}$ somersaults and twists can only be executed in position D,
- Dives with 2 or more somersaults and twists can only be executed in position B or C,
- Armstand dives with 1, $1 \frac{1}{2}$, or 2 somersaults and one or more twists can only be executed in position D, and
- Armstand dives with $2 \frac{1}{2}$ or more somersaults and twists can only be executed in position B or C.

1.6.5 The Appendixes 8, 9, 10 and 11 are established by the World Aquatics Technical Diving Committee (TDC) and approved by the World Aquatics Bureau.

2. COMPETITIONS

2.1 General

2.1.1 The order of diving shall be determined by a random draw prior to all preliminary competitions. The draw shall be held at the Technical Meeting prior to the preliminary competition. When available, an electronic draw shall be used.

2.1.2 In the semi-finals, the divers shall compete in reverse order of their ranking determined by the total scores at the end of the preliminary competition. In the case of a tie, the dive order shall be determined by a draw between the affected divers.

2.1.3 In the final competition, except where a tournament system is used, the divers shall compete in the reverse order of their ranking determined by the total scores at the end of the semi-final competition. In the case of a tie, the order shall be determined by a draw between the affected divers.

2.1.4 When the tournament system is used, the divers shall compete in all remaining sessions of the competition in the reverse order of their ranking determined by the total scores at the end of the preliminary competition. In the case of a tie, the order shall be determined by a draw between the affected divers. When there is a tie for the last position both divers will dive in the same semi-final.

2.1.5 The total number of dives executed in one session shall not exceed 210. In that case the session shall be divided into two or more sessions unless a double panel system is used.

2.1.6 If a diver is unable to compete at the beginning of any session, the diver ranked next shall advance to the next session, in order to have the prescribed number of divers in each session.

2.1.7 When two or more divers score the same number of points, a tie shall be declared for that particular place.

2.1.8 In the individual events, the diver with the highest total points shall be declared the winner of that event. The remaining divers shall be ranked by their final points.

2.1.9 In the synchronised and team events, the team with the highest total points shall be declared the winner of that event. The remaining teams shall be ranked by their final points.

The procedure for protests is outlined in I.13.1.

2.2 1 metre springboard

2.2.1 At the World Aquatics Championships there shall be a preliminary and final competition.

2.2.2 The final shall comprise the top twelve (12) ranked divers from the preliminary competition.

2.3 3 metre springboard and 10 metre platform

2.3.1 At the Olympic Games and World Aquatics Championships there shall always be a preliminary, a semi-final, and a final competition.

2.3.2 The semi-final shall comprise the top eighteen (18) ranked divers from the preliminary competition and the final shall comprise the top twelve (12) ranked divers from the semi-final.

2.3.3 The preliminary, semi-final, and final competition are separate events, each starting from zero (0) points.

2.4 Synchronised Diving – 3 metre springboard and 10 metre platform

2.4.1 There shall be a preliminary and a final competition.

2.4.2 At the World Aquatics Championships, the final shall comprise the top twelve (12) teams from the preliminary round.

2.4.3 The preliminary and final competitions are separate events, each starting from zero (0) points.

2.4.4 In the case of the Olympic Games, if pre-qualification of the number of teams is required, competitions may be held separately and in advance of different venues to establish the teams that qualify.

2.5 Team Diving – 3 metre springboard and 10 metre platform combined

2.5.1 There shall be a direct final.

2.6 Mixed Synchronised Diving – 3 metre springboard and 10 metre platform

2.6.1 There shall be a direct final.

3. COMPETITION FORMAT

3.1 All individual and synchronised diving competitions for men shall comprise six (6) dives.

3.2 All individual and synchronised diving competitions for women shall comprise five (5) dives.

3.3 No dive of the same number shall be repeated within each six (6) or five (5) dives.

3.4 1 metre and 3 metre springboard – men and women

3.4.1 The Women's springboard competitions shall comprise five (5) dives from five (5) different groups without limit of degree of difficulty.

3.4.2 The Men's springboard competitions shall comprise six (6) dives from five (5) different groups without limit of degree of difficulty.

3.5 Platform – men and women

3.5.1 The Women's platform competitions shall comprise five (5) dives from five (5) different groups without limit of degree of difficulty.

3.5.2 The Men's platform competitions shall comprise six (6) dives from six (6) different groups without limit of degree of difficulty.

3.5.3 At all World Aquatics competitions (Olympic Games, World Aquatics Championships, Diving World Cups and other World Aquatics events, other than Age group competitions), only dives from the 10 metre platform may be executed.

3.6 Synchronised diving

3.6.1 The synchronised diving competition involves two competitors diving simultaneously from the springboard or platform. The competition is judged on how the two divers individually perform their dives and how the two divers as a team synchronise their performance.

3.6.2 At Olympic Games and all World Aquatics Events the teams shall comprise two competitors of the same Federation.

3.6.3 Every competition for women and for mixed synchro on 3m springboard and platform shall comprise five (5) rounds of dives from five (5) different groups. The first two (2) rounds of dives with an assigned degree of difficulty of 2.0 for each dive regardless of the formula and three (3) rounds of dives without limit of degree of difficulty. All forward facing dives on springboard shall be done with a running approach.

3.6.4 Every competition for men on 3m springboard and platform shall comprise six (6) rounds of dives from five (5) different groups. The first two (2) rounds of dives with an assigned degree of difficulty of 2.0 for each dive regardless of the formula and four (4) rounds of dives without limit of degree of difficulty. All forward facing dives on springboard shall be done with a running approach.

3.6.5 In each round the two divers must perform the same dive (same dive number and same position).

3.7 Mixed Team Event

3.7.1 The Mixed Team Event consist of at least one female and

one male diver but no more than four (4) divers.

3.7.2 At all World Aquatics Events the teams shall comprise competitors of the same Federation.

3.7.3 Every competition shall comprise six (6) different dives without limit of degree of difficulty from six (6) different groups.

3.7.4 Two (2) dives shall be executed by the female competitor and two (2) dives by the male competitor. Two (2) dives shall be executed by a mixed synchronised team of one male and one female diver. Three (3) dives shall be executed from the 3m springboard and the other three (3) dives from the 10m platform.

3.7.5 In the Mixed Team Event the following rounds will be performed.

Round 1: female diver from the 3m springboard

Round 2: male diver from the 3m springboard

Round 3: mixed synchronised team (1 female and 1 male diver) from the 3m springboard

Round 4: female diver from the 10m platform Round 5: male diver from the 10m platform

Round 6: mixed synchronised team (1 female and 1 male diver) from the 10m platform.

3.8 Mixed Synchronised diving

3.8.1 At the World Aquatics Championships, Diving World Cups and other World Aquatics Diving Events additional Mixed Synchronised Diving Events can be conducted.

3.8.2 At all World Aquatics Events the teams shall comprise two (2) divers [one (1) male and one (1) female] of the same Federation.

3.8.3 Every competition for Mixed Synchronised on 3m springboard and 10m platform shall comprise five (5) rounds of dives from five (5) groups.

3.8.4 The first two (2) rounds of dives with an assigned degree of difficulty of 2.0 regardless of the formula and three (3) rounds of dives without limit of degree of difficulty.

4. STATEMENT OF DIVES

4.1 Each diver, or diver's representative, shall deliver to the Referee, or their designated representative, a complete statement of the selected dives on the official form of the event for the preliminary competition and all the following sessions of the competition.

4.2 The diver and the diver's representative are responsible for the accuracy of the statement in the list and the statement of dives shall be signed by the diver and the diver's representative.

4.3 The statement of dives shall be submitted no later than 24 hours before the commencement of the preliminary competition in each event.

4.4 The Referee may accept any statement of dives submitted after the 24 hour deadline, up to three (3) hours prior to the commencement of the preliminary competition, provided it is accompanied by a fee equivalent of 250 Swiss Francs.

4.5 Unless the statement is presented within the time prescribed, a diver shall not be admitted to the competition.

4.6 In all competitions, the diver or the diver's representative may change the statement of dives before the commencement of any semi-final or final of the competition, provided the amended statement is lodged with the Referee, or their designated representative, no later than thirty (30) minutes after the end of the previous session of the competition. If a new statement of dives is not submitted within the prescribed time, the diver shall perform the dives as indicated in the previous submission.

4.7 In any competition, (individual or synchronised), a diver may be replaced by another diver of the same Federation up to three (3) hours before the commencement of the preliminary competition. An official substitution form must be submitted and signed by the diver, coach and Referee. In synchronised diving events at the Olympic Games the replacement may also take place three (3) hours before the commencement of the final competition. The Referee will accept a change in the statement of dives.

4.8 In individual, synchronised and team events, when the closing

times have passed (see IV.4.3 and IV.4.4), no change may be made to the statement of dives.

4.9 The statement of dives shall contain the following information in the order of execution of the dives:

- The number of each dive according to Rules IV.1.5.1 to IV.1.5.7
- The position of the dive according to Rule IV.1.5.8
- The height of the board or platform
- The degree of difficulty as determined by the Formula described in Rule IV.1.6.

4.10 The dives in each round shall be executed by all the divers consecutively, according to the starting order.

4.11 The statement of dives shall take precedence over the indicator board and any announcement.

5. COMPETITION PROCEDURE

5.1 Control of Competition

5.1.1 Every competition shall be controlled by a Referee, and in some cases supported by Assistant Referees, together with Judges and a Secretariat.

5.1.2 The number and the position of the dive to be performed shall be displayed on an indicator board visible to both divers and judges.

5.1.3 Where possible a computer shall be used with the capability to run a competition and to produce a judging analysis.

5.1.4 When electronic scoring equipment is not available the judges must have flash cards to display their awards. These flash cards must be capable of showing awards from 0 to 10 by half points.

5.2 Composition of the Judges Panels

5.2.1 Whenever possible at the Olympic Games, World Aquatics Championships and Diving World Cups, seven (7) judges shall be used for individual and team events and eleven (11) judges for synchronised diving events. For synchronised diving, where eleven (11) judges are used, five (5) shall judge synchronisation of the dive, three (3) shall judge the execution of one diver and three (3) the execution

of the other diver.

5.2.2 In all individual and team competitions other than the Olympic Games, World Aquatics Championships and Diving World Cups, five (5) judges may be used. In all synchronized diving competitions, other than Olympic Games, World Aquatics Championships and Diving World Cups, nine (9) judges may be used. Five (5) shall judge the synchronisation of the dive, two (2) shall judge the execution of one diver and two (2) the execution of the other diver.

5.2.3 Provided sufficient judges are available, the panel of judges for the final competition shall consist of judges whose nationality is different to that of any of the divers in the competition.

5.2.4 When considered suitable, double panels of judges may be used in the same event. If double panels are used, the second panel is introduced in the fourth round of the competition. Note: In exceptional circumstances, such as high heat and humidity, the panels may be changed after the end of any round.

5.2.5 The Referee shall place the judges on each side of the springboard or platform in use, as outlined in Rule IV.13.5.3. When this is not practical, the judges may be placed together on one side.

5.2.6 Once placed, a judge shall not change position unless at the discretion of the Referee, and then only in exceptional circumstances.

5.2.7 When a judge is unable to continue to function after a competition has started, they shall be replaced by the reserve judge.

5.2.8 After each dive, on a signal given by the Referee, each judge shall immediately and simultaneously, without communicating with one another, and in a distinct manner, indicate the award for the dive. When an electronic judging device is used, the judges shall enter their awards into their electronic score pads immediately after the performance of the dive.

5.2.9 The judges' awards shall be displayed on the electronic scoreboard, preferably unseen by the judges. The awards (without any other information about the standing of the competition) must be seen by the judges on their electronic score pads.

6. DUTIES OF THE REFEREE AND ASSISTANT REFEREES

6.1 The Referee shall be in control of the competition and located in a position so that they can manage the competition and ensure that the Rules are observed.

6.2 The Assistant Referees:

- shall observe the diver(s) on the platform (if no camera is available),
- in synchronised diving, will be positioned on the opposite side of the pool to observe the performance of the diver on that side.

6.3 Duties of the Referee before the competition

6.3.1 The Referee shall inspect the statements of dives. If the statement does not comply with the Rules, the Referee shall have it corrected before the beginning of the competition.

6.3.2 The diver, or the diver's representative, shall be informed of the Referee's decision, that a correction is required, as soon as possible.

6.4 Duties of the Referee during the competition

6.4.1 In the case of unforeseen circumstances, the Referee may declare a short break, a postponement, or a discontinuation of the competition. If possible, the break should be done after a full round of dives.

6.4.2 Following an interruption, the competition shall be continued from where it was stopped. The points scored before the interruption shall be carried forward into the remaining portion of the competition, whenever it is held. The final results must be based on the last complete round of dives.

10 NOTE: If the competition cannot be continued, the result will be determined by the Jury of Appeal.

6.4.3 When there is a strong wind, the Referee may give a diver the right to make a re-start without deduction of points.

6.4.4 Before each dive, the Referee or the official announcer shall announce in the language of the host country the name of the diver and the dive to be executed. In competitions where different platforms are used the height of the platform shall also be

announced. If a scoreboard is used, all information concerning the dive shall be displayed and the announcement may be restricted to the identification of the diver.

6.4.5 When a dive is incorrectly announced, the diver or their representative shall advise the Referee immediately, who shall then confirm the diver's statement of dives.

6.4.6 If the incorrectly announced dive is executed by the diver, the Referee may cancel it and have the correct dive announced and performed immediately. The awards for the first dive must be noted should a protest be lodged.

6.4.7 The dive shall be executed after a signal given by the Referee. The signal shall not be given before the diver has assumed their position on the board or platform and the Referee has checked the indicator board. For backward and inward take-offs, the diver shall not proceed to the end of the springboard or platform until after the signal has been given by the Referee.

6.4.8 Each diver shall be given sufficient time for the preparation and execution of the dive, but if it takes more than one minute after the Referee has given a warning, the diver shall receive zero (0) points for the dive announced.

6.4.9 When a diver executes a dive before the signal is given, the Referee shall decide whether the dive shall be repeated.

6.4.10 In exceptional circumstances, the Referee may allow a diver to repeat a Dive without penalty. The awards for the first dive must be noted should a protest be lodged.

6.4.11 The request for such a repetition must be made immediately by the diver or their representative.

6.4.12 When the Referee is certain that a diver has performed a dive of a number other than that announced, the Referee shall declare it a failed dive.

6.4.13 When it is quite clear that the dive has been performed in a position other than that announced, the Referee shall repeat the announcement, and declare that the maximum award shall be 2 points, before giving the judges the signal to show their marks. If a judge then awards more than 2 points, the Referee shall declare the

award from that judge to be 2 points.

6.4.14 During the execution of a dive, there shall be no assistance to the diver from any person. Assistance between dives shall be permitted.

6.4.15 The Referee may declare a dive to be failed if they consider that assistance has been given by anyone to the diver after starting signal.

6.4.16 When a diver refuses to execute a dive, the Referee shall declare a failed dive.

6.4.17 If a diver in a competition disturbs a contest, the Referee may exclude them from that competition. If a member of a team, a coach or an official disturbs a contest, the Referee may exclude that person from the competition area.

6.4.18 The Referee may remove any judge from the competition whose judgement they regard as unsatisfactory and may appoint another judge to replace them. At the end of the competition the Referee shall make a written report to the Jury of Appeal.

6.4.19 Such a change of judge shall take place only at the end of a session or round of dives performed by each diver.

6.5 Duties of the Referee during the dive

6.5.1 When a diver in a running dive takes a step and stops or in a standing dive stops the movement for the take-off after the legs have commenced to press, the Referee shall declare there has been a re-start and shall deduct 2 points from the award of each judge.

6.5.2 When there is a restart in a running, standing, or armstand dive, the Referee shall deduct 2 points from the award of each judge.

6.5.3 When a second attempt (a re-start) is unsuccessful, the Referee shall declare a failed dive.

6.5.4 If the diver double bounces on the end of the springboard or double jumps on the end of the platform before take-off, the Referee shall declare it a failed dive.

11 Note: Double bounce on the springboard: Feet leave the

*springboard, arm swing and two distinct knee bends before the take-off.
Double jump on the platform: Feet leave the platform and two distinct knee bends before the take-off.*

6.5.5 When in a running dive the final step is not from one foot, the Referee shall declare it a failed dive.

6.5.6 When the take-off from the springboard is not from both feet simultaneously, the Referee shall declare it a failed dive.

6.5.7 When at the entry a twist is greater or less than that announced by 90 degrees or more, the Referee shall declare it a failed dive.

6.5.8 When one or both arms are held above the head in a feet first entry or below the head in a head first entry, the Referee shall declare the maximum award to be 4½ points. If a judge then awards more than 4½ points, the Referee shall declare the award from that judge to be 4½ points.

6.5.9 In head first dives, if the feet enter the water before the head or hands, the Referee shall declare it a failed dive.

6.5.10 In feet first dives, if the head or hands enter the water before the feet, the Referee shall declare it a failed dive.

6.6 Duties of the Referee after the competition

6.6.1 At the end of the competition the Referee shall confirm the final results by their signature.

7. DUTIES OF THE SECRETARIAT

7.1 The records of the competitions shall be kept by two independent secretaries.

7.2 In order to facilitate the scoring, a computer, a rapid calculator, or a chart may be used.

7.3 In individual and team events, the judges' awards shall be announced in their seating order, and the first secretary shall record all awards as announced on the diver's statement of dives. In synchronised diving events, the judges awards shall be announced, starting with the execution judges awards in seating order, followed by the synchronised judges awards, also in seating

order. When a computer and a scoreboard are used, the announcement of the judges awards is not necessary and the secretary may record the awards directly from the monitor.

7.4 The second secretary shall enter on the diver's statement of dives the judges' awards. When a computer is used to determine the scores, the second secretary may record the awards directly from the monitor.

7.5 In the individual and team events, when seven (7) judges are used, the secretaries shall cancel the two (2) highest and the two (2) lowest judges' awards. When more than two (2) awards are equal only two of the equal awards shall be cancelled. If only five (5) judges are used, the secretaries shall cancel the highest and the lowest award.

7.6 In synchronised diving, when eleven (11) judges are used, the secretaries shall cancel the highest and the lowest judges' awards given for execution for one diver, the highest and lowest judges' awards for execution of the other diver and the highest and lowest judges' awards given for synchronisation. When more than two (2) awards are equal only two of the equal awards may be cancelled.

7.7 In synchronised diving, when nine (9) judges are used, the secretaries shall cancel the highest and the lowest judges' awards given for execution and the highest and lowest judges' awards given for synchronisation. When two (2) or more awards are equal, either of the equal awards may be cancelled.

7.8 The secretaries shall independently add the remaining awards and multiply this total by the degree of difficulty for the dive to determine the score of the dive according to the following examples:

Individual and team competitions

Five (5) judges: $8.0, 7.5, 7.5, 7.5, 7.0 = 22.5 \times 2.0 = 45.0$

Seven (7) judges: $8.0, 7.5, 7.5, 7.5, 7.5, 7.5, 7.0 = 22.5 \times 2.0 = 45.0$

Synchronised Diving competitions

Nine (9) judges:

Execution diver 1: 7.0, 6.5

Execution diver 2: 5.5, 5.5

Synchro awards: ~~8.5~~, 8.0, 8.0, 7.5, ~~7.5~~ = $35.5 \div 5 \times 3 = 21.3 \times 2.8$
= 59.64

Eleven (11) judges:

Execution diver 1: 7.0, 6.5, ~~6.0~~

Execution diver 2: ~~5.5~~, 5.5, 7.0

Synchro awards: ~~8.0~~, 8.0, 7.5, 8.0, ~~7.0~~ = $35.5 \div 5 \times 3 = 21.3 \times 2.8$
= 59.64

7.9 When a judge by reason of illness or any other unforeseen circumstances, has made no award for a particular dive, the average of the awards of the other judges shall be adopted as the missing award. The award shall be rounded up or down to the nearest half point or whole point. Averages ending in .01 to .24 shall be lost. Averages ending in .25 to .74 shall be rounded to .50. Averages ending in .75 or higher shall be rounded up to the next whole point.

7.10 In synchronised diving, when a judge (execution or synchronised) by reason of illness or any other unforeseen circumstances, has made no award for a particular dive, in an eleven (11) judge panel, the average of the awards of the other two (2) execution judges of the same diver, or the average of the other four synchronised judges, shall be adopted as the missing award. The average award shall be rounded up or down to the nearest half point or whole point. Averages ending in .01 to .24 shall be lost. Averages ending in .25 to .74 shall be rounded to .50. Averages ending in .75 or higher shall be rounded up to the next whole point. In a nine (9) judge panel, the award of the other execution judge of the same diver shall be adopted as the missing award.

7.11 At the end of the competition the two secretaries shall collate the score sheets.

7.12 The result of the competition shall be obtained from the score sheets.

7.13 If an electronic officiating equipment is in use, only one

secretariat may be used. The secretariat records the awards and the electronic result only, to make sure that the final result can be calculated in a case that the electronic officiating equipment breaks down.

7.14 The final result at World Aquatics events shall be announced in one of the official languages of World Aquatics (English or French).

8. JUDGING

8.1 General

8.1.1 A judge shall award from 0 to 10 points for a dive according to their overall impression within the following criteria:

| | |
|--------------------------|-----------|
| Excellent | 10 |
| Very Good | 8.5 – 9.5 |
| Good | 7.0 – 8.0 |
| Satisfactory | 5.0 – 6.5 |
| Deficient | 2.5 – 4.5 |
| Unsatisfactory | 0.5 – 2.0 |
| Completely failed | 0 |

8.1.2 When judging a dive, the judge must not be influenced by any factor other than the technique and execution of the dive. The dive must be considered without regard to the approach to the starting position, the difficulty of the dive, or any movement beneath the surface of the water.

8.1.3 The points to be considered in judging the overall impression of a dive are the technique and grace of:

- the starting position and the approach
- the take-off
- the flight
- the entry

8.1.4 When a dive is performed clearly in a position other than that

announced the dive shall be deemed unsatisfactory. The highest award for such a dive is 2 points.

8.1.5 When a dive is performed partially in a position other than that announced, each judge shall deduct according to their opinion.

8.1.6 When a dive is not performed in the straight (A), pike (B), tuck (C), or free (D) position as described, the judge shall deduct from ½ to 2 points, according to their opinion.

8.1.7 When a judge considers that a dive of a different number has been performed, they may award zero (0) points, notwithstanding that the Referee has not declared it to be a failed dive.

8.2 The starting position

8.2.1 When the signal is given by the Referee, the diver shall take the starting position.

8.2.2 In the starting position the body shall be straight, head erect, with the arms straight in any position.

8.2.3 When the body in the starting position is not straight, head erect, with the arms straight in any position, each judge shall deduct ½ to 2 points, according to their opinion.

8.2.4 Standing dives

8.2.4.1 The starting position in standing dives shall be assumed when the diver stands on the front end of the springboard or platform.

8.2.4.2 When executing a standing dive, the feet must stay in contact with the springboard or platform until the take-off.

8.2.4.3 If the feet leave the springboard or platform before the take-off, the judge shall deduct from ½ to 2 points, according to their opinion.

8.2.5 Running dives

8.2.5.1 The starting position in a running dive shall be assumed when the diver is ready to take the first step of the run.

8.2.6 Armstand dives

8.2.6.1 The starting position in an armstand dive shall be assumed when both hands are on the front end of the platform and both feet are off the platform.

8.2.6.2 When, in an armstand dive, a stationary and steady balance in the straight vertical position is not shown, or if the hands lose contact with the platform during the take-off, each judge shall deduct from 0.5 to 2 points, according to their opinion.

8.2.6.3 A re-start shall be permitted when a diver loses their balance, or when one or both feet return to the platform, or when one or any part of their body other than their hands touches the platform. When a diver moves one or both hands from the original position at the front end of the platform, this shall be deemed as a re-start.

8.3 The approach

8.3.1 When executing a running dive from either the springboard or the platform, the run shall be smooth, aesthetically pleasing, and in a forward direction to the end of the springboard or platform with the final step being from one foot.

8.3.2 When the run is not smooth, aesthetically pleasing, or in a forward direction to the end of the springboard or platform, each judge shall deduct ½ to 2 points, according to their opinion.

8.3.3 When the final step is not from one foot, the judge may award zero (0) points, notwithstanding that the Referee has not declared it to be a failed dive.

8.3.4 The diver must not double bounce on the end of the springboard or double jump on the end of the platform before the take-off. When the judge considers that the diver has double bounced or double jumped in a dive, the judge may award zero (0) points, notwithstanding that the Referee has not declared it to be a failed dive.

12 NOTE: Double bounce on the springboard or double jump on the platform: Feet leave the springboard or platform, double arm swing and/or two distinct knee bends before the take-off

8.4 The take-off

8.4.1 The take-off in forward and reverse dives may be performed either standing or running at the option of the diver. The take-off in backward and inward dives must be performed standing.

8.4.2 The take-off from the springboard shall be from both feet simultaneously. The reverse take-off from the platform may be from one foot.

8.4.3 When the take-off from the springboard is not from both feet, the judge may award zero (0) points, notwithstanding that the Referee has not declared it to be a failed dive.

8.4.4 In running and standing dives, the take-off shall be, balanced and high and shall be from the end of the springboard or platform.

8.4.5 When the take-off is not balanced and high, or from the end of the springboard or platform, each judge shall deduct $\frac{1}{2}$ to 2 points, according to their opinion.

8.4.6 In dives with twist, the twisting shall not be manifestly done from the springboard or platform. If the twisting is manifestly done from the springboard or platform, each judge shall deduct $\frac{1}{2}$ to 2 points, according to their opinion.

8.5 The flight

8.5.1 During the execution of a dive the dive shall be in the direct line of flight.

8.5.2 If during the execution of a dive a diver dives to the side of the direct line of flight, each judge shall deduct according to their opinion.

8.5.3 If during the execution of a dive, a diver touches the end of the springboard or platform with their feet or hands, each judge shall deduct according to their opinion.

8.5.4 If during the execution of a dive, where visual technology is unavailable a diver is unsafely close to the springboard or platform or touches the end of the springboard or platform with their head, the judges shall award up to a maximum of 2 points. If the majority of the judges (at least three (3) in a 5 judge panel / at least four (4) in a 7 judge panel) award two (2) or less points, all higher scores shall be two (2)

points. The judges indicate to the Referee by the use of electronic technology or where electronic technology is not available by raising one hand that the two (2) or less points are in relation to the unsafely close execution of the dive. Where Video Assistant Referee is available, the Referee will receive a signal from the appointed technology partner that a potential unsafe dive has been performed and is available to review. An award of a maximum of two (2) points from each judge may be recorded subject to the Referee's decision.

The dive can be executed in the following positions:

Straight (A)

8.5.5 In the straight position the body shall not be bent either at the knees or hips. The feet shall be together and the toes pointed. The position of the arms is at the option of the diver.

8.5.6 Should the straight position not be aesthetically pleasing and shown as described, each judge shall deduct from $\frac{1}{2}$ to 2 points, according to their opinion.

8.5.7 In all flying dives a straight position shall be clearly shown and that position shall be assumed from the take off or after one somersault. When the straight position is not shown for at least one quarter of a somersault (90°) in dives with one (1) somersault, and at least one half of a somersault (180°) in dives with more than one (1) somersault, the maximum award by the judges shall be 4 $\frac{1}{2}$ points.

Pike (B)

8.5.8 In the pike position the body shall be bent at the hips, but the legs must be kept straight at the knees, the feet shall be together, and the toes pointed. The position of the arms is at the option of the diver.

8.5.9 Should the pike position not be aesthetically pleasing and shown as described, each judge shall deduct from $\frac{1}{2}$ to 2 points, according to their opinion.

8.5.10 In the pike dives with twist, the pike position must be clearly shown. Should this position not be shown, each judge shall deduct $\frac{1}{2}$ to 2 points, according to their opinion.



13 *These diving illustrations serve as a guide only and the position of the arms is at the choice of the diver except in the entry.*

Tuck (C)

8.5.11 In the tuck position the body shall be compact, bent at the knees and hips with the knees and feet close together within the bodyline of the shoulders. The hands shall be on the lower legs and the toes pointed.

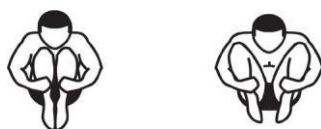

8.5.12 Should the tuck position not be aesthetically pleasing and shown as described, each judge shall deduct from $\frac{1}{2}$ to 2 points, according to their opinion.

8.5.13 In tuck dives with twist, the tuck position must be clearly shown. Should this position not be shown, each judge shall deduct $\frac{1}{2}$ to 2 points, according to their opinion.



14 *These diving illustrations serve as a guide only and the position of the arms is at the choice of the diver except in the case of the hands in the tuck and the entry.*

Free position (D)

8.5.14 In the free position, the body position is optional (A, B or C) but the legs shall be together and the toes pointed.

8.5.15 Should the free position not be shown as described, each judge shall deduct from $\frac{1}{2}$ to 2 points, according to their opinion.

8.5.16 In somersault dives with twist, the twist may be performed at any time during the flight.

8.6 The entry

8.6.1 The entry into the water shall in all cases be vertical, not twisted, with the body straight, the feet together, and the toes pointed.

8.6.2 When the entry is short or over, twisted or the body not straight, the feet not together, and the toes not pointed, each judge shall deduct according to their opinion.

8.6.3 In head first entries, the arms shall be stretched beyond the head and in line with the body, with the hands close together. If one or both arms are held below the head on entry, the judge may award up to $4\frac{1}{2}$ points, notwithstanding that the Referee has not declared a maximum award of $4\frac{1}{2}$.

8.6.4 In feet first entries, the arms shall be close to the body with no bending at the elbows. If one or both arms are held beyond the head on entry, the judge may award up to $4\frac{1}{2}$ points, notwithstanding that the Referee has not declared a maximum award of $4\frac{1}{2}$.

8.6.5 Other than as provided in Rules IV.8.6.3 and IV.8.6.4, when the arms are not in the correct position in either the head first or feet first entry, each judge shall deduct from $\frac{1}{2}$ to 2 points, according to their opinion.

8.6.6 When at the entry a twist is greater or less than that announced by 90 degrees or more, the judge may award zero (0) points, notwithstanding that the Referee has not declared it to be a failed dive.

8.6.7 The dive is considered to have been completed when the whole of the body is completely under the surface of the water.

9. REFEREEING AND JUDGING SYNCHRONISED DIVING

9.1 Synchronised diving is judged by the execution of the

individual dives and the synchronisation of the divers.

9.2 The rules for judging individual diving shall apply to the execution of dives in synchronised diving, except that where one or both divers perform a dive of a different number or position, other than that announced, the Referee shall declare it a failed dive.

9.3 When judging the synchronisation of the dives, the overall impression of the synchronisation of the dives must be taken into account.

9.4 The factors to be considered in judging synchronised diving are:

- the starting position, the approach and the take-off, including the similarity of the height,
- the coordinated timing of the movements during the flight,
- the similarity of the vertical angles of the entries,
- the comparative distance from the springboard or platform of the entry,
- the coordinated timing of the entries.

9.5 If either diver enters the surface of the water before the other diver leaves the springboard or platform, the Referee shall declare it a failed dive.

9.6 The Referee shall declare a two-point deduction from all judges when there is a re- start by one or both divers.

9.7 The execution judges must not be influenced by any factor other than the technique and execution of the dive, not both dives, nor the synchronisation of the divers.

9.8 When an execution judge considers that a dive of a different number has been performed by a diver, the judge shall award zero (0) points notwithstanding that the Referee has not declared it to be a failed dive. If both execution judges of one diver in a nine (9) judge panel or all three (3) execution judges in an eleven (11) judge panel, award zero (0) points, the Referee shall declare it a failed dive. If the Referee declares a failed dive, zero (0) points are awarded by all nine (9) or eleven (11) judges.

9.9 The synchronisation judges must not be influenced by any other factor other than the coordinated performance of the two divers and not the execution of both dives.

9.10 If all the synchronisation judges award zero (0) points, the Referee shall declare it a failed dive.

9.11 When any of the following faults are shown, each synchronisation judge shall deduct from ½ to 2 points, according to their opinion, for the lack of:

- similarity of the starting position, approach, take-off or height,
- coordinated timing of the movement during the flight,
- similarity of the vertical angles of the entries,
- comparative distance from the springboard or platform of the entry,
- coordinated timing of the entries.

9.12 In synchronised diving all forward facing dives on the springboard must be performed with a running approach (see IV.3.6.4). If a forward facing dive is not performed with a running approach the Referee shall declare it a failed dive.

10. SUMMARY OF THE PENALTIES

10.1 Referee to declare "Failed Dive": 0 points

IV.6.4.8 If the diver takes more than one minute, after a warning.

IV.6.5.4 If a diver double bounces on the end of the springboard or double jumps on the end of the platform before take-off.

IV.6.5.5 If the final step is not from one foot.

IV.6.5.6 If the take-off on the springboard is not from both feet simultaneously.

IV.6.5.7 If a twist is greater or less than that announced by 90 degrees or more.

IV.6.4.12 If a diver has performed a dive of a number other than that announced.

IV.6.5.8.1 If the feet enter the water before the head or hands in a head first dive.

IV.6.5.8.2 If the head or hands enter the water before the feet in a feet first dive.

IV.6.4.15 If assistance has been given to the diver after the

starting signal.

IV.6.5.3 When a second attempt (a re-start) is unsuccessful.

IV.6.4.16 If a diver refuses the execution of a dive.

IV.9.2 In synchronised diving if a diver, or both divers, perform a dive of a different number or position.

IV.9.5 In synchronised diving if either diver enters the surface of the water before the other diver leaves the springboard or platform.

IV.9.8 In synchronised diving if all execution judges for one diver award zero (0) points

IV.9.10 In synchronised diving if all synchronisation judges award zero (0) points.

10.2 Referee to declare "2 points deduction"

IV.6.5.1 If a diver takes a step and stops in a running dive or stops the movement for a standing take-off after the legs have commenced to press.

IV.6.5.2 If there is a re-start in a standing, running, or armstand dive.

IV.9.6 In synchronised diving if there is a re-start by one or both divers.

10.3 Referee to declare "2 points maximum"

IV.6.4.13 If a diver performs a dive in a position other than that announced.

10.4 Referee to declare "4 ½ points maximum"

IV.6.5.8 If a diver has one or both arms held above the head in a feet first entry or below the head in a head first entry.

10.5 Judges to award "0 points"

IV.8.1.7 If a dive of a different number has been performed.

IV.8.3.3 If the final step is not from one foot.

IV.8.3.4 If a diver double bounces on the end of the springboard or double jumps on the end of the platform before the

take-off.

IV.8.4.3 If the take-off from the springboard is not from both feet simultaneously.

IV.8.6.6 If a twist is greater or less than that announced by 90° or more.

IV.9.8 If an execution judge considers that a dive of a different number has been performed.

10.6 Judges to award "2 points maximum"

IV.8.1.4 If a dive is performed clearly in a position other than that announced.

IV.8.5.4 If in a dive, a diver is unsafely close to the springboard or platform or touches the end of the springboard or platform with their head.

10.7 Judges to award "4 ½ points maximum"

IV.8.5.7 If in a flying dive, a straight position is not clearly shown for at least one quarter of a somersault (90°) in dives with somersault and at least a half somersault (180°) in dives with more than 1 somersault.

IV.8.6.3 If the arms are held below the head in a head first entry.

IV.8.6.4 If one or both arms are held above the head in a feet first entry.

10.8 Judges to deduct "from ½ to 2 points"

IV.8.1.6 If a dive is not performed in a position as described.

IV.8.2.3 If the starting position is not straight, head erect, with the arms straight in any position.

IV.8.2.4 .3 If the feet leave the springboard or platform (crow-hop) before the take-off in a standing dive.

IV.8.2.6.2 If in an armstand dive, a stationary and steady balance in the straight vertical position is not shown.

IV.8.3.2 If the run is not smooth, aesthetically pleasing in a forward direction to the end of the springboard or platform.

- IV.8.4.5** If the take-off is not bold, high, and confident.
- IV.8.4.6** If in a twist dive, the twisting is manifestly done from the springboard or platform.
- IV.8.5.6** If the straight position is not shown as described.
- IV.8.5.9** If the pike position is not shown as described.
- IV.8.5.10** If in a pike dive with twist, the pike position is not clearly shown.
- IV.8.5.12** If the tuck position is not shown as described.
- IV.8.5.13** If in a tuck dive with twist, the tuck position is not clearly shown.
- IV.8.5.15** If the free position is not shown as described.
- IV.8.6.5** If the arms are not in the correct position in either the head first or feet first entry.
- IV.9.11** In synchronised diving if any of the following are not shown:
- similarity of the starting position, approach, take-off and height;
 - coordinated timing of the movement during the flight;
 - similarity of the vertical angles of the entries;
 - comparative distance from the springboard or platform of the entry;
 - coordinated timing of the entries.

10.9 Judges to deduct "according to individual opinion"

- IV.8.1.5** If a dive is performed partially in a position other than that announced.
- IV.8.5.2** If in a dive, the diver dives to the side of the direct line of flight.
- IV.8.5.3** If in a dive, a diver touches the end of the springboard or platform with their feet or hands.
- IV.8.6.2** If the entry into the water is not vertical, or nearly so, or twisted with the body not straight, the feet not together, and the toes not pointed.

11. DIVING AT THE WORLD AQUATICS CHAMPIONSHIPS AND

OLYMPIC GAMES

At the Olympic Games and the World Aquatics Championships, in springboard and platform Diving contests, only dives prescribed by the World Aquatics Rules for Diving shall be executed.

11.1 Programme of the Olympic Games

| | <u>Men</u> | <u>Women</u> |
|--------------|------------|--------------|
| Springboard | 3m | 3m |
| Platform | 10m | 10m |
| Synchronised | 3m, 10m | 3m, 10m |

11.2 Programme of the World Aquatics Championships

| | <u>Men</u> | <u>Women</u> | <u>Mixed Team Event</u> |
|--------------|------------|--------------|-------------------------|
| Springboard | 1m, 3m | 1m, 3m | 3m |
| Platform | 10m | 10m | 10m |
| Synchronised | 3m, 10m | 3m, 10m | 3m, 10m |

12. AGE GROUP RULES - DIVING

12.1 World Aquatics Rules of competition will apply in all agegroup competitions.

12.2 Age Categories

All age group divers remain qualified from the 1st of January to midnight of the following 31st of December in the year of competition.

12.3 Diving Events

12.3.1 Group A

12.3.1.1 Age

16, 17, or 18 years on December 31st of the year of the competition.

12.3.1.2 Competition Format

12.3.1.2.1 Individual Events

Girls' Springboard – 1 metre and 3 metre

This competition shall comprise nine (9) different dives; five (5) dives each selected from a different group, the total degree of difficulty shall not exceed 9.5 for 3 metre events and 9.0 for 1 metre events, and four (4) dives without limit of degree of difficulty, each dive selected from a different group.

Girls' Platform – 5 metre – 7.5 metre – 10 metre

This competition shall comprise eight (8) different dives; four (4) dives each selected from a different group, the total degree of difficulty shall not exceed 7.6, and four (4) dives without limit of degree of difficulty, each dive selected from a different group. At least five (5) different groups must be used.

Boys' Springboard – 1 metre and 3 metre

This competition shall comprise ten (10) different dives; five (5) dives each selected from a different group, the total degree of difficulty shall not exceed 9.5 for 3 metre events and 9.0 for 1 metre events, and five (5) dives without limit of degree of difficulty, each dive selected from a different group.

Boys' Platform – 5 metre – 7.5 metre – 10 metre

This competition shall comprise nine (9) different dives; four (4) dives each selected from a different group, the total degree of difficulty shall not exceed 7.6, and five (5) dives without limit of degree of difficulty, each dive selected from a different group. All six (6) groups must be used.

12.3.1.2.2 A / B combined**Girls' and Boys' Synchronised Diving – 3 metre**

This competition shall comprise five (5) dives; two (2) rounds of dives with an assigned degree of difficulty of 2.0 for each dive regardless of formula, and three (3) rounds of dives without limit of degree of difficulty. The five (5) dives must be selected from at least four (4) different groups.

Girls' and Boys' Synchronised Diving – platform (5m, 7.5m, 10m)

This competition shall comprise five (5) dives; two (2) rounds of dives with an assigned degree of difficulty of 2.0 for each dive regardless of formula, and three (3) rounds of dives without limit of degree of difficulty.

The five (5) dives must be selected from at least four (4) different groups.

Juniors Mixed Team Event

The team consists of at least one female and one male diver but no more than four (4) divers.

In the team there must be at least 1 diver from B group.

6 dives are performed in total and must include all 6 groups.

Event includes 2 individual dives from 3m: one performed by a male diver and one by a female diver.

The dives are performed without DD limit.

Event includes 2 individual dives from 5, 7.5 or 10 meter platform height: one performed by a male diver and one by a female diver.

The dives are performed without DD limit.

Event includes 2 mixed synchronised dives: one performed from 3m springboard and one from 5, 7.5 or 10 meter platform height.

The dives are performed without DD limit.

All teams follow the same format in each round (outlined below). In the Mixed Team Event the following rounds will be performed.

- | | |
|-----------------|---|
| Round 1: | female diver from the 3m springboard |
| Round 2: | male diver from the 3m springboard |
| Round 3: | mixed synchronised team (1 female and 1 male diver) from the 3m springboard |
| Round 4: | female diver from 5, 7.5 or 10 meter platform |
| Round 5: | male diver from 5, 7.5, or 10 meter platform |
| Round 6: | mixed synchronised team (1 female and 1 male diver) from 5,7.5, or 10 meter platform. |

12.3.2 Group B

12.3.2.1 Age

14 or 15 years on December 31st of the year of the competition.

12.3.2.2 Competition Format

12.3.2.2.1 Individual Events

Girls' Springboard – 1 metre and 3 metre

This competition shall comprise eight (8) different dives; five (5) dives each selected from a different group, the total degree of difficulty shall not exceed 9.5 for 3 metre events and 9.0 for 1 metre events, and three (3) dives without limit of degree of difficulty, each dive selected from a different group.

Girls' Platform – 5 metre – 7.5 metre – 10 metre

This competition shall comprise seven (7) different dives; four (4) dives each selected from a different group, the total degree of difficulty shall not exceed 7.6, and three (3) dives without limit of degree of difficulty, each dive selected from a different group. At least five (5) different groups must be used.

Boys' Springboard – 1 metre and 3 metre

This competition shall comprise nine (9) different dives; five (5) dives each selected from a different group, the total degree of difficulty shall not exceed 9.5 for 3 metre events and 9.0 for 1 metre events, and four (4) dives without limit of degree of difficulty, each dive selected from a different group.

Boys' Platform – 5 metre – 7.5 metre – 10 metre

This competition shall comprise eight (8) different dives; four (4) dives each selected from a different group, the total degree of difficulty shall not exceed 7.6, and four (4) dives without limit of degree of difficulty, each dive selected from a different group. All least five (5) different groups must be used.

12.3.3 Group C

12.3.3.1 Age

12 or 13 years on December 31st of the year of the competition.

12.3.3.2 Competition Format

12.3.3.2.1 Individual Events

Girls' Springboard – 1 metre and 3 metre

This competition shall comprise seven (7) different dives; five (5) dives

each selected from a different group, the total degree of difficulty shall not exceed 9.5 for 3 metre events and 9.0 for 1 metre events, and two (2) dives without limit of degree of difficulty, each dive selected from a different group.

Girls' Platform – 5 metre or 7.5 metre

This competition shall comprise six (6) different dives; four (4) dives each selected from a different group, the total degree of difficulty shall not exceed 7.6, and two (2) dives without limit of degree of difficulty, each dive selected from a different group.

Boys' Springboard – 1 metre and 3 metre

This competition shall comprise eight (8) different dives; five (5) dives each selected from a different group, the total degree of difficulty shall not exceed 9.5 for 3 metre events and 9.0 for 1 metre events, and three (3) dives without limit of degree of difficulty, each dive selected from a different group.

Boys' Platform – 5 metre or 7.5 metre

This competition shall comprise seven (7) different dives; four (4) dives each selected from a different group, the total degree of difficulty shall not exceed 7.6, and three (3) dives without limit of degree of difficulty, each dive selected from a different group.

12.4 General Rules for World Aquatics Junior Diving Championships

12.4.1 World Aquatics Junior Diving Championships shall be conducted every two years in Groups A and B.

12.4.2 Each Federation is entitled to enter a maximum of two (2) divers in individual events and one (1) team in synchronised diving events.

12.4.3 Each diver shall only compete in their age group.

12.4.4 Each diver shall perform a full list of dives as indicated in their age group.

12.4.5 Each individual diving event shall be a preliminary and final competition, irrespective of the number of entrants and may be conducted in more than one session.

12.4.5.1 The top twelve (12) divers from the previous session will participate in a final competition performing only dives without limit. The scores of the dives with limit from the previous session will be carried forward and added to the scores in the final competition to determine the top twelve (12) rankings. Divers lower than twelfth place will be ranked by their preliminary scores.

12.4.5.2 When facilities allow, the opportunity for simultaneous preliminary events may be scheduled subject to the approval of the Bureau on recommendation of the Technical Diving Committee.

12.4.5.3 The program schedule shall be agreed by the Bureau upon recommendation of the Technical Diving Committee.

12.4.6 Each diver shall only compete in their age group. Either five (5) or seven (7) judges shall officiate in the individual events and nine (9) judges in the synchronised diving events. Note: If possible, eleven (11) judges in the synchronised diving events may be used.

12.4.7 The Championships shall normally be conducted separately and not in conjunction with Swimming, Water Polo or Artistic Swimming.

12.4.8 The World Aquatics Junior Diving Championships shall be conducted in a minimum period of seven (7) days.

13. DIVING FACILITIES AND EQUIPMENT

13.1 Diving Facilities

13.1.1 Springboard Diving

General requirements: Dimensions in metres for all diving facilities as detailed in Diving Diagrams, IV.13.5.1 (Appendix 1) and IV.13.5.2 (Appendix 2), shall be observed.

13.1.1.1 The springboards shall be 4.88 metres long and 0.5 metre wide. At all World Aquatics Events, the type of springboard which must have a slip-resistant surface shall be approved by World Aquatics.

13.1.1.2 The springboards shall be provided with movable fulcrums easily adjustable by the diver.

13.1.1.3 For springboard diving facilities modified or constructed on concrete platforms after 1st October 2013, the following shall be observed.

13.1.1.3.1 The vertical distance from the level of the platform, which supports the fulcrum assembly, to the level of the top of the springboard, shall be 0.35 metre.

13.1.1.3.2 The distance from the front edge of the fulcrum assembly (which is 0.741 metres in length) to the front edge of the supporting platform, shall be a maximum of 0.44 metre.

13.1.1.3.3 If the front edge of the platform projects past this point then the fulcrum assembly and the rear hinge assembly must be moved forward so as to provide for a maximum of 0.44 metres from the front edge of the platform to the front of the fulcrum assembly.

13.1.1.3.4 The concrete platform which supports the springboard shall be aligned with the pool wall or project over the pool.

13.1.1.4 The minimum distance recommended from the rear to the centre line of the fulcrum shall be in accordance with the recommendation or specification of the springboard manufacturer.

13.1.1.5 The springboards shall be installed dead level at the leading edge when the movable fulcrum is in all positions.

13.1.1.6 The springboards should be placed on either one or both sides of the platform. For Synchronised Diving, it is required that at least two springboards at the same height shall be placed side by side and no objects should obstruct the visibility in any part of the dive between the divers. *See Diving Diagrams IV.13.5.1 (Appendix 1) and IV.13.5.2 (Appendix 2).*

13.1.1.7 The back and sides of 3m springboards shall be surrounded by handrails with a minimum clearance of 1.0 metres between vertical pairs. The minimum height shall be 1.0

metre, measured from the level of the springboard, and they shall be with at least two horizontal crossbars placed outside the platform.

A solid transparent barrier is also permitted instead of a crossbar.

15 See Diagram: IV.13.5.1 (Appendix 1)

13.1.2 Platform Diving

13.1.2.1 Each platform shall be rigid and horizontal.

13.1.2.2 The minimum dimensions of the platform shall be:

| PLATFORM | WIDTH | LENGTH |
|---------------------|-------------------------|--------|
| 0.6m to 1.0m | 1.00m (2.90m preferred) | 5.00m |
| 2.6m to 3.0m | 1.00m (2.00m preferred) | 5.00m |
| 5.0m | 2.90m | 6.00m |
| 7.5m | 2.00m | 6.00m |
| 10.0m | 3.00m | 6.00m |

On

10m platforms, with a width of less than 3m, only the handrails on each side for a distance of at least 3.0m back from the front edge of the platform may be shaped as detailed next (see drawing).

It is recommended that an easily removable section of handrail be included for general use, which can be removed for synchronised diving. See Diagram below.

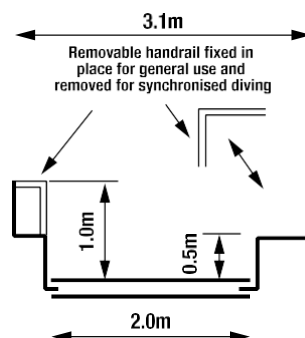

13.1.2.3 The thickness of the front edge of the platform shall be 0.2 metre but not exceeding 0.3 metre, and can be vertical or inclined at an angle not greater than 10° to the vertical inside the plummet line.

13.1.2.4 The surface and the front edge of the platform shall be covered throughout with a resilient slip-resistant material. The two surfaces shall be covered separately in order to achieve a clean 90° angle or as described in IV.13.1.2.3. The front surface is to be applied first and then the top surface.

The platforms shall be covered in a slip-resistant material that shall have a tread pattern that provides sufficient traction in wet and dry conditions such that the divers are prevented from slipping when performing dives in all directions. The minimum thickness must be 6mm and the colour should give a contrast to the surrounding décor. The material shall be easily cleaned to maintain the slip-resistant feature of the product.

13.1.2.5 The front edge of the 10 metre platform shall project at least 1.50 metres, the 7.5 metre, 5 metre and 2.6 – 3.0 metre platforms 1.25 metres, and the 0.6 – 1 metre platform 0.75 metre beyond the edge of the pool.

13.1.2.6 Where a platform is directly underneath another platform the platform above shall project a minimum of 0.75 metre (preferred 1.25 metres) beyond the platform below.

13.1.2.7 The back and sides of each platform (except 1.0 metre or lower platforms) shall be surrounded by handrails up to 1m from the edge of the platform with a minimum clearance of 1.0 metres between vertical pairs. The minimum height shall be 1.0 metre and they shall be with at least two horizontal crossbars placed outside the platform beginning 1.0 metre from the front edge of the platform.

A solid transparent barrier is also permitted instead of a crossbar.

13.1.2.8 Each platform shall be accessible by suitable stairs (not ladders) as required by the countries building regulations and or health and safety standards that are applicable.

13.1.2.9 It is preferable that a platform is not constructed directly under any other platform however in circumstance

where this cannot be avoided then you must refer to IV.13.5.1 (Appendix 1) and IV.13.5.2 (Appendix 2).

13.1.2.10 Requirements for the supporting structure. For platforms and supporting structure of the springboards the design load is $p = 350$ kiloponds (kilograms force) per lineal metre.

In addition to the static requirements and for the comfort and safety of the user with respect to the movement of the towers, the following limits shall be observed, with respect to the platforms and springboard supports.

Fundamental frequency of platforms 10.0 Hz

TOLERANCES:

| PLATFORM | MINIMUM | MAXIMUM |
|---------------------|---------|---------|
| 10m | 10 Hz | 20 Hz |
| 7.5m, 5m, 3m and 1m | 10 Hz | 30 Hz |

Fundamental frequency of tower 3.5 Hz Total oscillation of total structure ± 2 mm

The spatial deformation of the front edge of the platforms as a result of $P_x = P_y = P_z = 100$ kiloponds (kilograms force) shall be a maximum of 1

16 mm. See Drawing below.

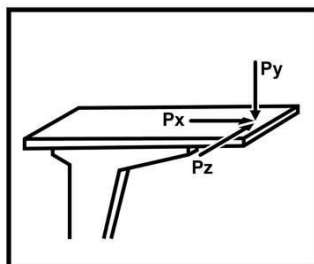

These requirements can be met most adequately by a reinforced concrete structure. Proof of the dynamic behavior is to be obtained together with the static calculations for the whole structure.

13.1.3 General Requirements

13.1.3.1 For pools designed and constructed after 26th September 2013 the minimum dimensions in metres for diving facilities as detailed on the Annexes IV.13.5.1 (Appendix 1) and IV.13.5.2 (Appendix 2) shall prevail, using, as a basic measuring point of reference, the plummet line, which is a vertical line extending through the centre of the front edge of the springboard or platform. It is recommended that the preferred dimensions be used for projects considered to have an important status.

13.1.3.2 The dimensions C from plummet to adjacent plummet in the tables of Annexes IV.13.5.1 (Appendix 1) and IV.13.5.2 (Appendix 2) apply to platforms with widths as detailed in IV.13.1.2.2. If platform widths are increased then the dimensions B and C shall be increased by half the additional widths.

13.1.3.3 With regard to dimensions for diving facilities a combination of preferred and minimum measurements found in the Appendices IV.13.5.1 (Appendix 1) and IV.13.5.2 (Appendix 2) shall be used. However, measurements less than minimum are not acceptable.

13.1.3.4 The vertical height from the plummet of the diving board and or springboard at rest to the water surface at rest and before water sprays or bubbles are set in motion shall be specified in the Diving Facilities Dimensions table. These measurements should be certified by a surveyor or other qualified officials, appointed or approved by or the member of the country in which the pool is situated.

13.1.3.5 The height of the springboards and each platform above the water level may vary by plus 0.05 metre and minus 0.00 metre from the heights prescribed in the Rules.

13.1.3.6 The end of 5, 3, and 1 metre platforms must not project beyond the ends of the 3 and 1 metre springboards when they are adjacent to each other.

13.1.3.7 In the area of full water depth, the bottom of the pool may rise up to 2%. In the diving pool, the depth of water shall not be less than 1.8 metres at any point.

13.1.3.8 In outdoor pools, best practice suggests that springboards and platforms are recommended to face north in the northern hemisphere and south in the southern hemisphere

13.1.3.9 Pool walls shall be vertical and form 90 degree right angles to the surface of the water. They shall be constructed of solid material, with a slip-resistant surface.

The admissible tolerance in walls verticality will be ± 0.3 degrees.

Rest ledges along the pool walls are permitted; they must be not less than 1.2 metres below the water surface, and may be 0.1 metre to 0.15 metre wide. Only internal rest ledges are permitted.

13.1.3.10 Mechanical surface agitation shall be installed under the diving facilities to aid the divers in their visual perception of the surface of the water. In pools equipped with an underwater bubble machine, the machine shall only be used for the purpose if it creates sufficient water agitation when working with a very low pressure; otherwise a horizontal water sprinkler system shall only be used.

13.1.4 Lighting

13.1.4.1 The minimum illumination at a level of 1 metre above the water surface shall not be less than 600 lux.

13.1.4.2 Sources of natural and artificial illumination shall be provided with controls to prevent glare.

13.1.5 Water temperature

The water temperature shall be not less than 28° Celsius.

13.1.6 Lane markings

For Diving pools that will also be used for swimming, lane markings for Diving pools shall be of a dark contrasting colour, placed on the floor of the pool in the centre of each lane.

Width: minimum 0.2 metre, maximum 0.3 metre.

Length: 21.0 metres for 25 metre long pools.

Each lane line shall end 2.0 metres from the end wall of the pool with a distinctive cross line 1.0 metre long and of the same width as the lane line.

Target line shall be placed on the end of the walls or on the touch panels, in the centre of each lane, of the same width as the lane lines. A cross line 0.5 metre long shall be placed 0.3 metre below the water surface, measured to the centre point of the cross line. They shall extend without interruption from the deck edge (curb) to the floor or to a maximum of 3 metres.

13.1.7 Placement and seating of diving judges

13.1.7.1 Individual diving

13.1.7.1.1 The judges will be placed side by side in a straight line on both sides of the diving pool by the Referee.

13.1.7.1.2 When seven (7) judges are officiating, four (4) will be on the side of the pool closest to where the springboard or platform event is being contested. When five (5) judges are officiating, (3) will be on the side of the pool closest to where the springboard or platform event is being contested.

Note: The Referee may decide to place the majority of judges (i.e. four (4) / three (3) as outlined above) on the side of the pool farthest from the springboard or platform event being contested if reasonable to do so for logistical or situational purposes.

13.1.7.1.3 No judge shall be seated inside or behind the direct line of the front edge of the springboards or platforms.

13.1.7.1.4 The chairs used by judges will be numbered clockwise in consecutive order when facing the springboards / platforms.

13.1.7.1.5 In 1 metre springboard competitions, chairs suitable for use placed directly on poolside shall be used.

13.1.7.1.6 In 3 metre springboard competitions, the judges shall be seated at a height of not lower than two (2) metres above the water level.

13.1.7.1.7 Three (3) or two (2) execution judges will be placed on both sides of the diving pool by the Referee.

13.1.7.1.8 To assist the judges in the 3 metre springboard and platform competitions, the judges chairs must be positioned as far back from the edge of the pool as

is practical.

13.1.7.1.9 The above recommendations are shown in the Annex IV.13.5.3 (Appendix 3).

13.1.7.2 Synchronised diving and mixed synchronized diving

13.1.7.2.1 Three (3) or two (2) execution judges will be placed on both sides of the diving pool by the Referee.

13.1.7.2.2 The chairs used by execution judges in a synchronised event will be numbered clockwise in consecutive order when facing the springboard / platform, for example E 1, E 2 and E 3 (or E 1, E 2) on the left side and E 4, E 5 and E 6 (or E 3, E 4) on the right side.

13.1.7.2.3 The synchronised judges will be placed in a straight line in between the execution judges on both sides of the pool. All synchronised judges on both sides of the pool must be placed at the same horizontal distance from the springboards or platforms (not side-to-side) but will be positioned at different heights to ensure that no judge's view is obstructed.

13.1.7.2.4 Three (3) synchronised judges will be on the side of the pool closest to where the springboard or platform event is being contested, and the other two (2) synchronised judges on the opposite side.

13.1.7.2.5 The chairs used by synchronised judges in a synchronised event will be numbered clockwise in consecutive order when facing the springboard or platform. Numbering will start at S1 with lowest chair on the left side of the pool, through to S5 for the highest chair on the right side of the pool.

13.1.7.2.6 In synchronised competitions, the synchronised judges closest to the pool edge, shall ideally be seated at a height of not lower than 2 (two) metres above the water level.

13.1.7.2.7 The subsequent chair heights for the remaining synchronised judges (or additional execution

judge) must increase by at least 50 cm per seat.

13.1.7.2.8 There shall be no interference or movement by any person in front of the judge chairs during a competition event.

13.1.7.2.9 The above recommendations are shown in the Annex IV.13.5.3 (Appendix 3).

13.2 Diving Facilities for Olympic Games and World Aquatics Championships

13.2.1 Springboard Diving

For Olympic Games and World Aquatics Championships, Rule IV.13.1.1 in total shall apply.

13.2.2 Platform Diving

For Olympic Games and World Aquatics Championships, Rule IV.13.1.2 in total shall apply.

13.2.3 General Requirements

For Olympic Games and World Aquatics Championships, Rule IV.13.1.3 in total shall apply.

13.2.4 Lighting

The light intensity at the level of 1 metre above the water surface shall not be less than 1500 lux.

13.2.5 Water temperature

The water temperature shall be not less than 26° Celsius.

13.2.6 Lane markings

Lane markings for the diving well will consist of 3 lines running the width of the diving well 90 degree angle to the diver facing forward on the springboard or platform. These lines shall be as follows:

Width: minimum 0.2 metre, maximum 0.3 metres

Length: 21.0 metre for 25 metre wide diving well

The distance between the centre points of each lane shall be 2.5 metres.

The centre of the first line shall be directly under the plummet of the 3 metre

springboard. See Appendix IV.13.5.3 (Appendix 3).

13.2.7 Placement and seating of diving judges

For Olympic Games and World Aquatics Championships, the rule IV.13.1.7 in total shall apply.

13.2.8 Dry Land Facilities

The host facility must provide a trampoline with spotting equipment and a hot tub. It is preferred that there be two trampolines and a dry land area with a springboard and a platform take-off into foam landing pits as detailed the appendices IV.13.5.4 (Appendix 4), IV.13.5.5 (Appendix 5), IV.13.5.6 (Appendix 6) and IV.13.5.7 (Appendix 7).

13.2.9 Field of play

Field of Play for Olympic Games and World Aquatics Championships as detailed in IV.13.5.3 (Appendix 3).

If the swimming pool and diving well are in the same area, the minimum distance separating the pools shall be of 8 metres, however 10 metres is preferred (see II.16.2.17).

13.3 Electronic Officiating Equipment for Diving

13.3.1 General description

Electronic Officiating equipment records the judges awards for each diver and determines the final score for each dive as required by Rule IV.7.

13.3.2 Preferred Equipment must be able to;

13.3.2.1 Record judges awards by whole and half points

13.3.2.2 Be able to display all recorded and calculated information for each diver both before and after each dive

13.3.2.3 Be able to display the scores for all divers before and after each dive

13.3.2.4 Be able to display the rank order and scores for all divers after each round of dives

13.3.2.5 The equipment must provide each judge with an electronic judging device that will permit each judge to enter their award and to see their award on a window on the device. After the referee has accepted the judges awards, all awards

shall be displayed on each electronic judging device

13.3.2.6 Judges analysis is to be provided at the conclusion of each event or series

13.3.2.7 The referee must be provided with a monitor on which they will be able to view the awards of all the judges prior to the awards then being displayed on the score board

13.3.2.8 There is a requirement for a print out of the following information;

1. The draw for the diving order
2. A start list for each session or event
3. A ranking of dives at the end of each round
4. A ranking of dives at the end of each event
5. Judges awards and scores for each diver at the end of each session and event

13.4 DRY LAND FACILITIES

13.4.1 General Requirements

Dimensions in metres for Dry Land Facilities as detailed in the Appendices IV.13.5.4 (Appendix 4), IV.13.5.5 (Appendix 5), IV.13.5.6 (Appendix 6) and IV.13.5.7 (Appendix 7).

13.4.2 For the safety, practise and development of divers and competitions, it is strongly recommended that the guidelines presented below be incorporated into the facility and placed adjacent to the competitive diving area /facilities.

13.4.3 When minimum dimensions are used in B and C a vertical mat or other protective surface should be attached to the appropriate forward and side walls.

13.5 Appendices

APPENDIX 1 – Diagram Diving Facilities

APPENDIX 2 – Table Diving Facilities

APPENDIX 3 – Diagram Diving Field of Play for Olympic and World Championships

APPENDIX 4 – Diagram Diving Dry Land Facilities

APPENDIX 5 – Diagram Diving Dry Land Facilities Details

APPENDIX 6 – Table Diving Dry Land Facilities

APPENDIX 7 – Equipment In Dry Land Facilities

APPENDIX 8 – Springboard World Aquatics Degree of Difficulty – Formula and Components

APPENDIX 9 – Springboard World Aquatics Table of Degree of Difficulty

APPENDIX 10 – Platform World Aquatics Degree of Difficulty – Formula and Components

APPENDIX 11 – Platform World Aquatics Table of Degree of Difficulty

13.5.1 Appendix 1 – Diagram Diving Facilities

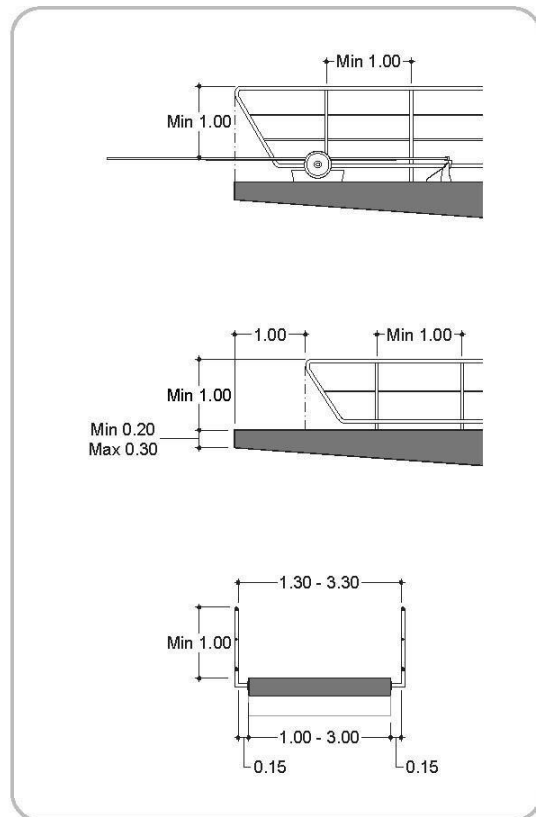
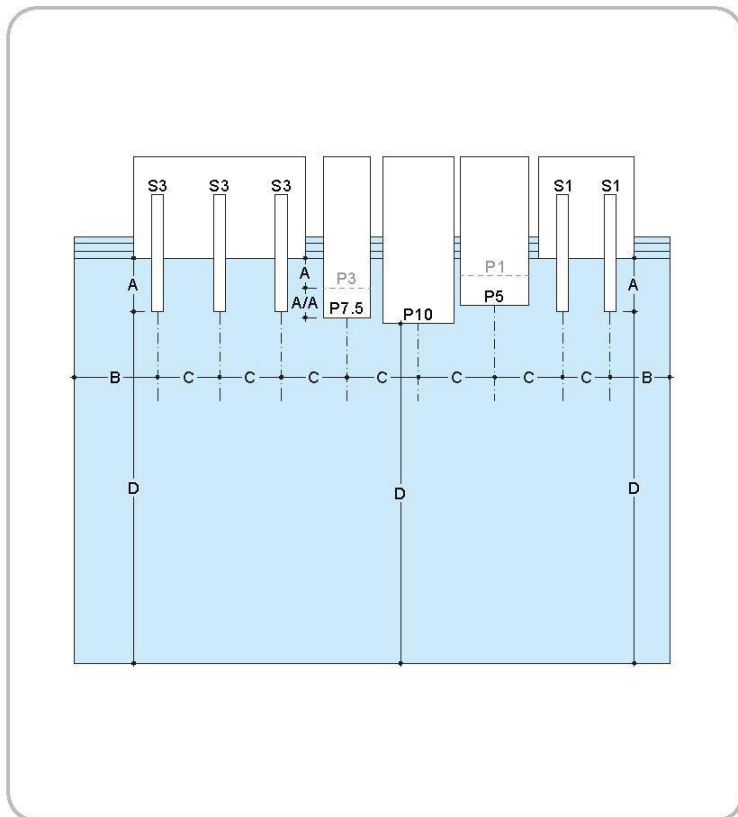
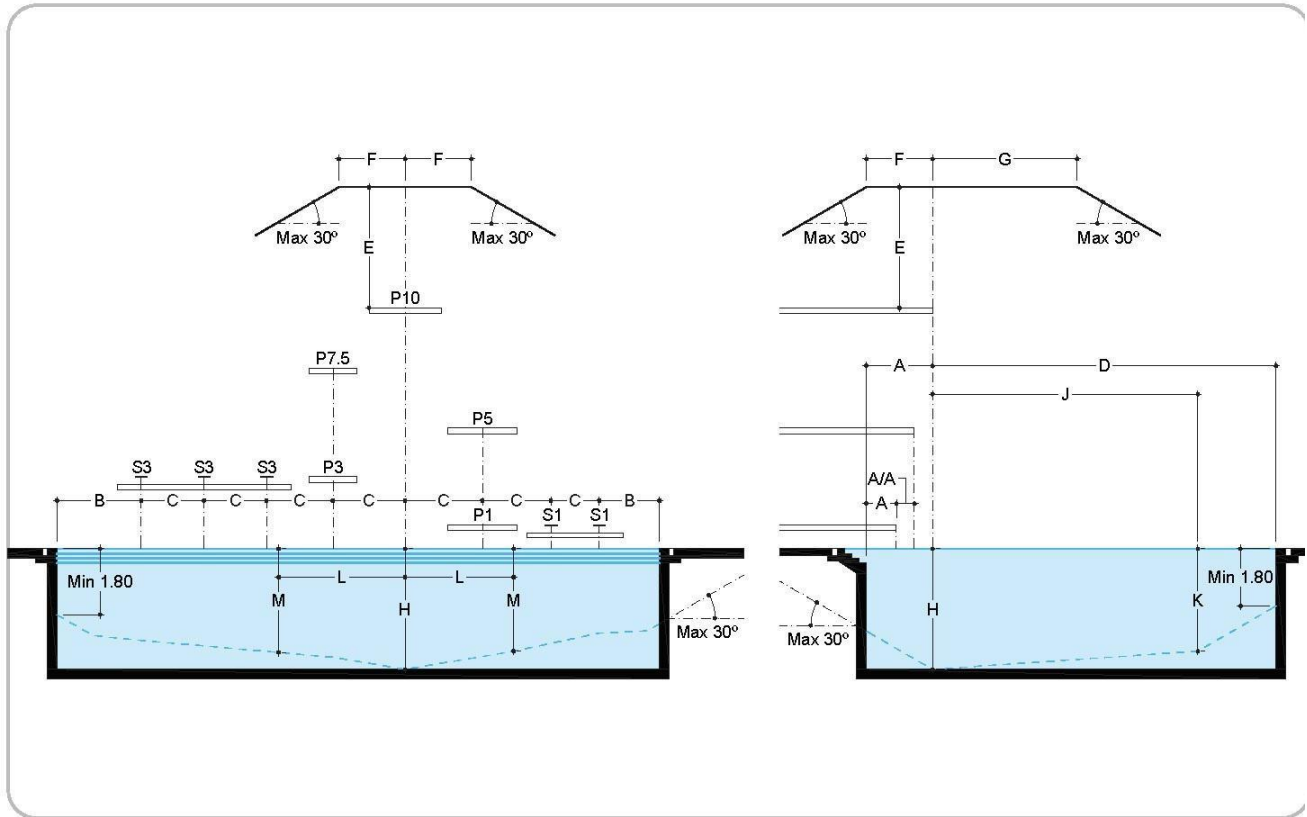

13.5.2 Appendix 2 – Table Diving Facilities

| Dimensions for Diving Facilities | | SPRINGBOARD | | | | | | PLATFORM | | | | | | | | |
|----------------------------------|--|-------------|------|----------|-----------|-------------------------|-------|-------------------------|-----------|----------|-----------|------------|--------------|-----------|------------------|------|
| | | 1 metre | | 3 metres | | 1 metre | | 3 metres | | 5 metres | | 7.5 metres | | 10 metres | | |
| | Length | 4.88 | | 4.88 | | 5.00 | | 5.00 | | 6.00 | | 6.00 | | 6.00 | | |
| | Width | 0.50 | | 0.50 | | 1.00 min. 2.90 pref. | | 1.00 min. 2.00 pref. | | 2.90 | | 2.00 | | 3.00 | | |
| | Height | 1.00 | | 3.00 | | 0.60 min. 1.00 pref. | | 2.60 min. 3.00 pref. | | 5.00 | | 7.50 | | 10.00 | | |
| A | From plummet back to pool wall platform edge for Concrete Platform | Designation | A-1 | | A-3 | | A-1P | | A-3P | | A-5 | | A-7.5 | | A-10 | |
| | | Minimum | 2.22 | | 2.22 | | 0.75 | | 1.25 | | 1.25 | | 1.25 | | 1.50 | |
| | | Preferred | 2.22 | | 2.22 | | 0.75 | | 1.25 | | 1.25 | | 1.25 | | 1.50 | |
| A/A | From plummet Back to Platform Plummet directly below | Designation | | | | | | | | | A/A 5/1 | | A/A 7.5/3,1 | | A/A 10/5, 3, 1 | |
| | | Minimum | | | | | | | | | 0.75 | | 0.75 | | 0.75 | |
| | | Preferred | | | | | | | | | 1.25 | | 1.25 | | 1.25 | |
| B | From plummet to Pool Wall at Side | Designation | B-1 | | B-3 | | B-1P | | B-3P | | B-5 | | B-7.5 | | B-10 | |
| | | Minimum | 2.50 | | 3.50 | | 2.50 | | 3.00 | | 4.00 | | 4.50 | | 5.75 | |
| | | Preferred | 2.50 | | 3.50 | | 2.50 | | 3.60 | | 4.50 | | 4.75 | | 5.75 | |
| C | From plummet to Adjacent Plummet | Designation | C1-1 | | C3-3, 3-1 | | C1-1P | | C3-3P, 1P | | C5-3, 5-1 | | C7.5-5, 3, 1 | | C10-7.5, 5, 3, 1 | |
| | | Minimum | 2.00 | | 2.20 | | 1.85 | | 2.20* | | 2.85* | | 2.75* | | 3.00* | |
| | | Preferred | 2.00 | | 2.60 | | 2.15 | | 2.35* | | 2.85* | | 2.75* | | 3.00* | |
| D | From plummet to Minimum Pool Wall Ahead | Designation | D-1 | | D-3 | | D-1P | | D-3P | | D-5 | | D-7.5 | | D-10 | |
| | | Minimum | 9.00 | | 10.25 | | 8.00 | | 9.50 | | 10.25 | | 11.00 | | 13.50 | |
| | | Preferred | 9.00 | | 10.25 | | 8.00 | | 9.50 | | 10.25 | | 11.00 | | 13.50 | |
| E | On plummet from Board to Ceiling | Designation | E-1 | | E-3 | | E-1P | | E-3P | | E-5 | | E-7.5 | | E-10 | |
| | | Minimum | 5.00 | | 5.00 | | 3.25 | | 3.25 | | 3.25 | | 3.25 | | 4.00 | |
| | | Preferred | 5.00 | | 5.00 | | 3.50 | | 3.50 | | 3.50 | | 3.50 | | 5.00 | |
| F | Clear Overhead behind and each side of plummet | Designation | F-1 | E-1 | F-3 | E-3 | F-1P | E-1P | F-3P | E-3P | F-5 | E-5 | F-7.5 | E-7.5 | F-10 | E-10 |
| | | Minimum | 2.50 | 5.00 | 2.50 | 5.00 | 2.75 | 3.25 | 2.75 | 3.25 | 2.75 | 3.25 | 2.75 | 3.25 | 2.75 | 4.00 |
| | | Preferred | 2.50 | 5.00 | 2.50 | 5.00 | 2.75 | 3.50 | 2.75 | 3.50 | 2.75 | 3.50 | 2.75 | 3.50 | 2.75 | 5.00 |
| G | Clear Overhead ahead of plummet | Designation | G-1 | E-1 | G-3 | E-3 | G-1P | E-1P | G-3P | E-3P | G-5 | E-5 | G-7.5 | E-7.5 | G-10 | E-10 |
| | | Minimum | 5.00 | 5.00 | 5.00 | 5.00 | 5.00 | 3.25 | 5.00 | 3.25 | 5.00 | 3.25 | 5.00 | 3.25 | 5.00 | 4.00 |
| | | Preferred | 5.00 | 5.00 | 5.00 | 5.00 | 5.00 | 3.50 | 5.00 | 3.50 | 5.00 | 3.50 | 5.00 | 3.50 | 5.00 | 5.00 |
| H | Depth of Water at plummet | Designation | H-1 | | H-3 | | H-1P | | H-3P | | H-5 | | H-7.5 | | H-10 | |
| | | Minimum | 3.40 | | 3.70 | | 3.20 | | 3.50 | | 3.70 | | 4.10 | | 4.50 | |
| | | Preferred | 3.50 | | 3.80 | | 3.30 | | 3.60 | | 3.80 | | 4.50 | | 5.00 | |
| J K | Distance and Depth ahead of plummet for all stands | Designation | J-1 | K-1 | J-3 | K-3 | J-1P | K-1P | J-3P | K-3P | J-5 | K-5 | J-7.5 | K-7.5 | J-10 | K-10 |
| | | Minimum | 5.00 | 3.30 | 6.00 | 3.60 | 4.50 | 3.10 | 5.50 | 3.40 | 6.00 | 3.60 | 8.00 | 4.00 | 11.00 | 4.25 |
| | | Preferred | 5.00 | 3.40 | 6.00 | 3.70 | 4.50 | 3.20 | 5.50 | 3.50 | 6.00 | 3.70 | 8.00 | 4.40 | 11.00 | 4.75 |
| L M | Distance and Depth each side of plummet | Designation | L-1 | M-1 | L-3 | M-3 | L-1P | M-1P | L-3P | M-3P | L-5 | M-5 | L-7.5 | M-7.5 | L-10 | M-10 |
| | | Minimum | 1.50 | 3.30 | 2.00 | 3.60 | 1.40 | 3.10 | 1.80 | 3.40 | 3.00 | 3.60 | 3.75 | 4.00 | 4.50 | 4.25 |
| | | Preferred | 2.00 | 3.40 | 2.50 | 3.70 | 1.90 | 3.20 | 2.30 | 3.50 | 3.50 | 3.70 | 4.50 | 4.40 | 5.25 | 4.75 |
| N | Maximum slope to reduce dimensions beyond full requirements for pool depth and ceiling height = 30 Degrees | | | | | | | | | | | | | | | |

Notes

- The minimum distance between adjacent platforms must be at least 0.25 metres.
- Dimensions B (plummet to pool wall at side) and C (plummet to adjacent plummet) apply to Platforms with widths as detailed in V 13.1.2.2. If Platform widths are increased, then B and C shall be increased by half the additional width(s).
- The 10 Metre Platform must project 0.25 metres beyond any adjacent platform.
- All platforms must project 0.75 metres beyond any platform directly below.
- The leading edge of the concrete platforms for springboards must be at least constructed to be directly above the pool wall or beyond.
- V 13.1.3.6. The end of 5, 3 and 1m platforms must not project beyond the ends of the 3m and 1m springboards when they are adjacent to each other.

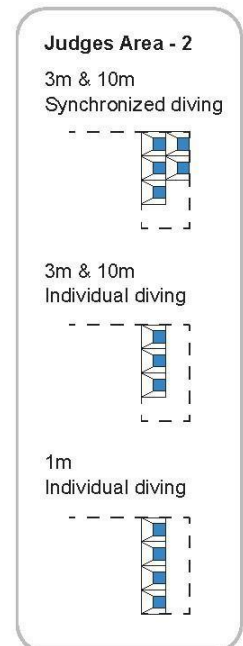
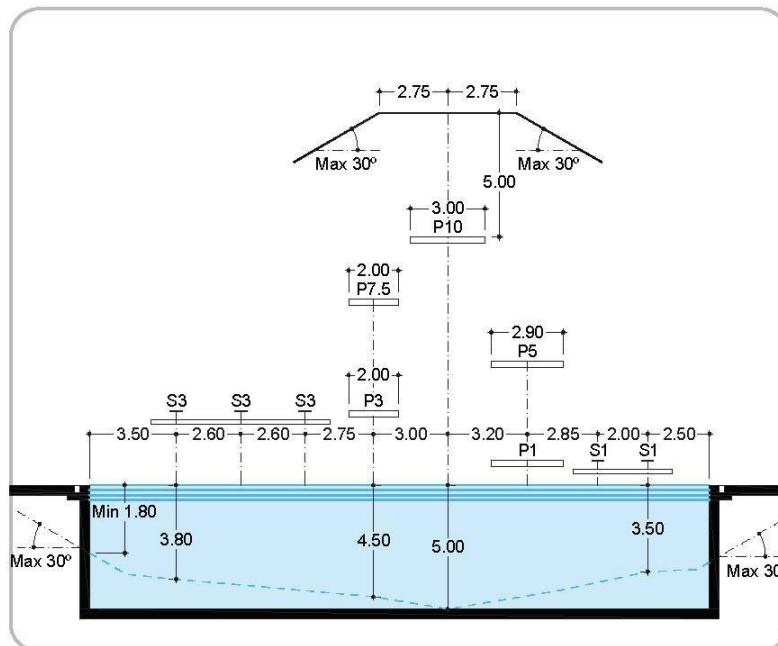
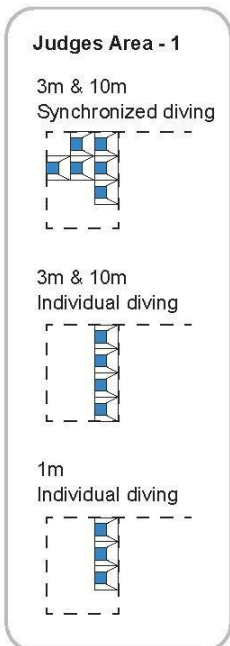
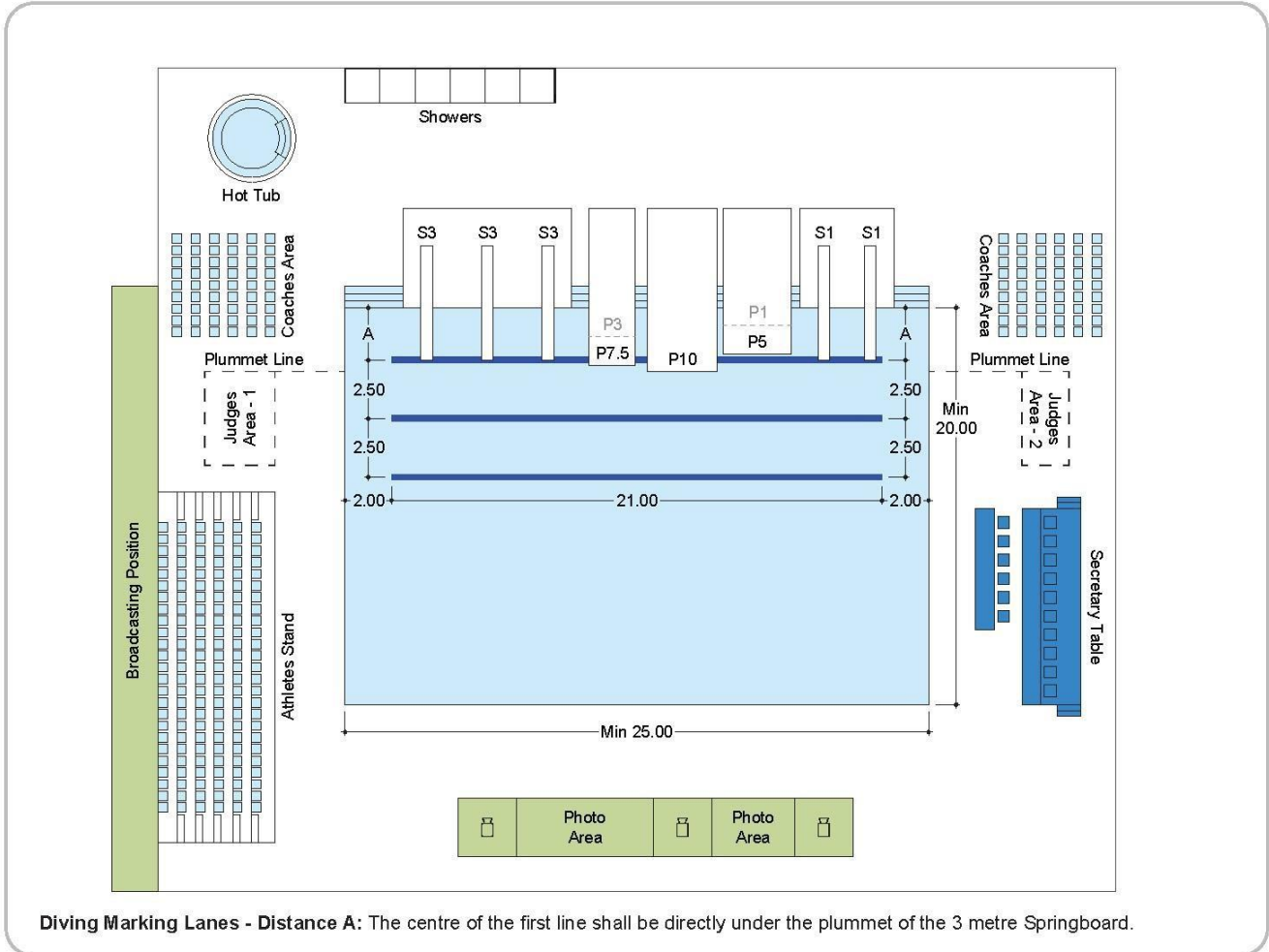
13.5.3 Appendix 3 – Diagram Diving Field of Play for Olympic Games and World Championships

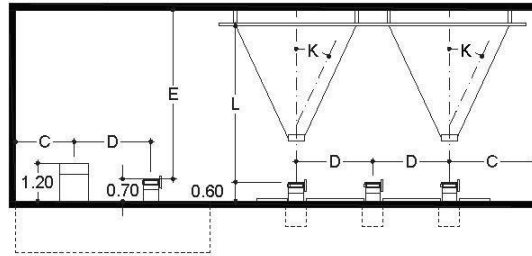
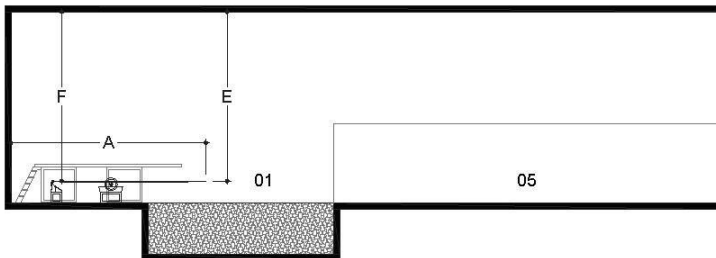
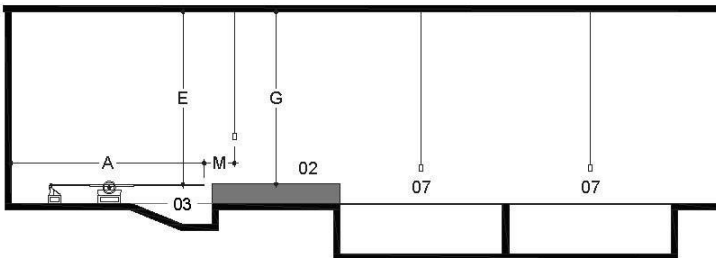
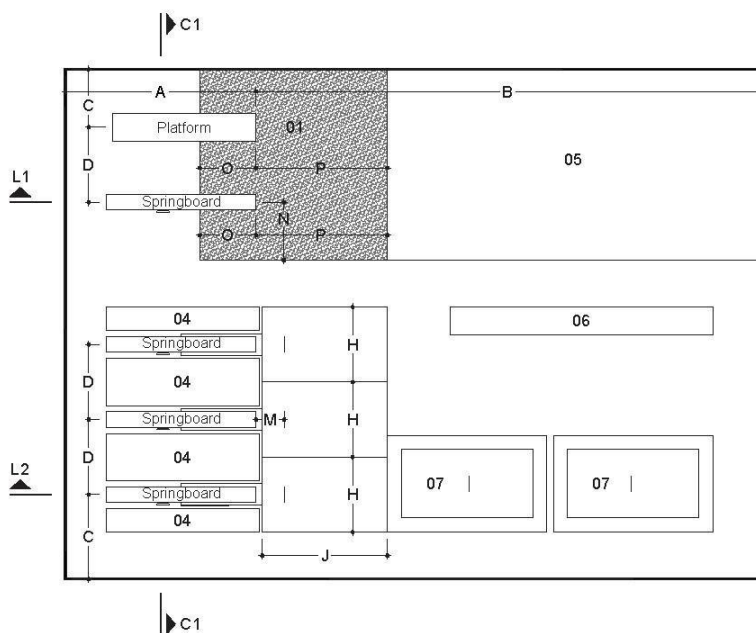

13.5.4 Appendix 4- Diagram Diving Dry Land Facilities

Cross Section - C1

Longitudinal Section - L1

Longitudinal Section - L2

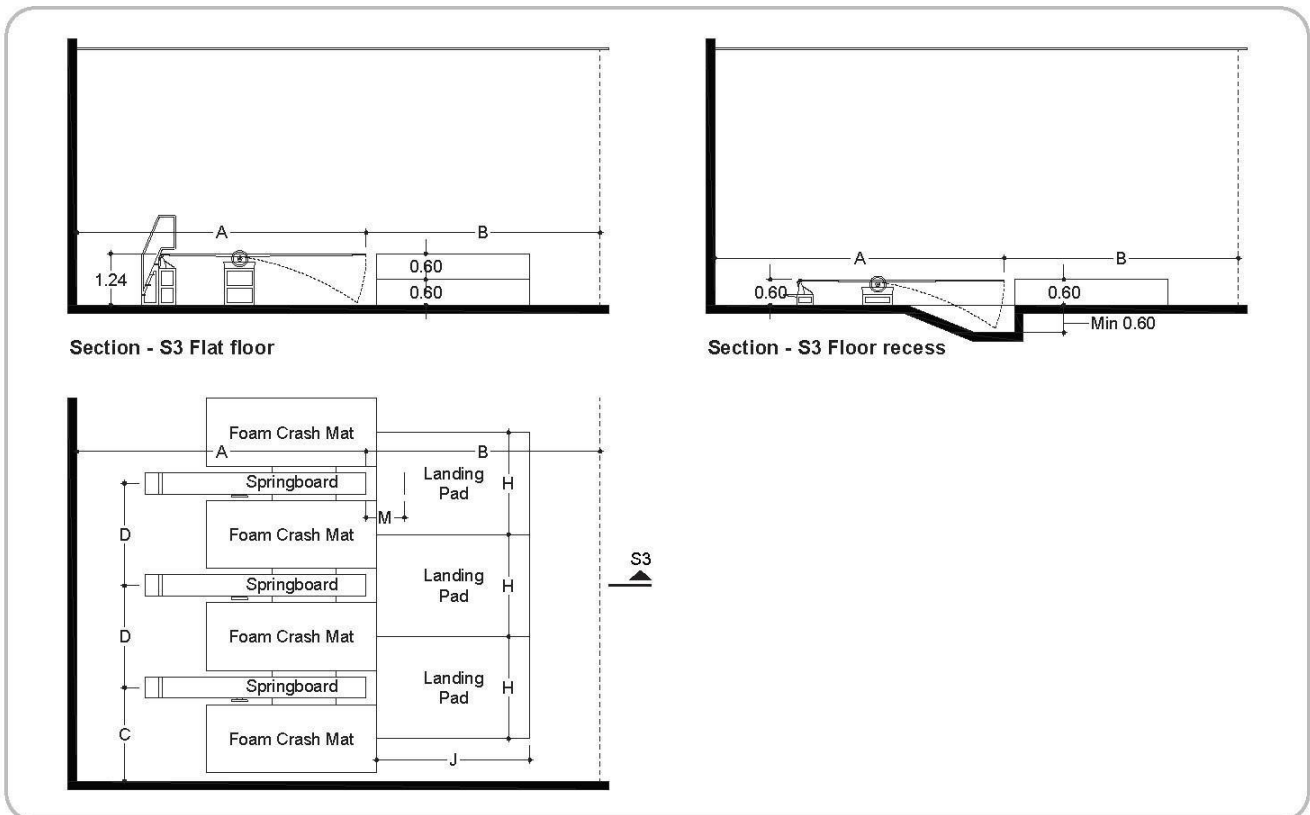
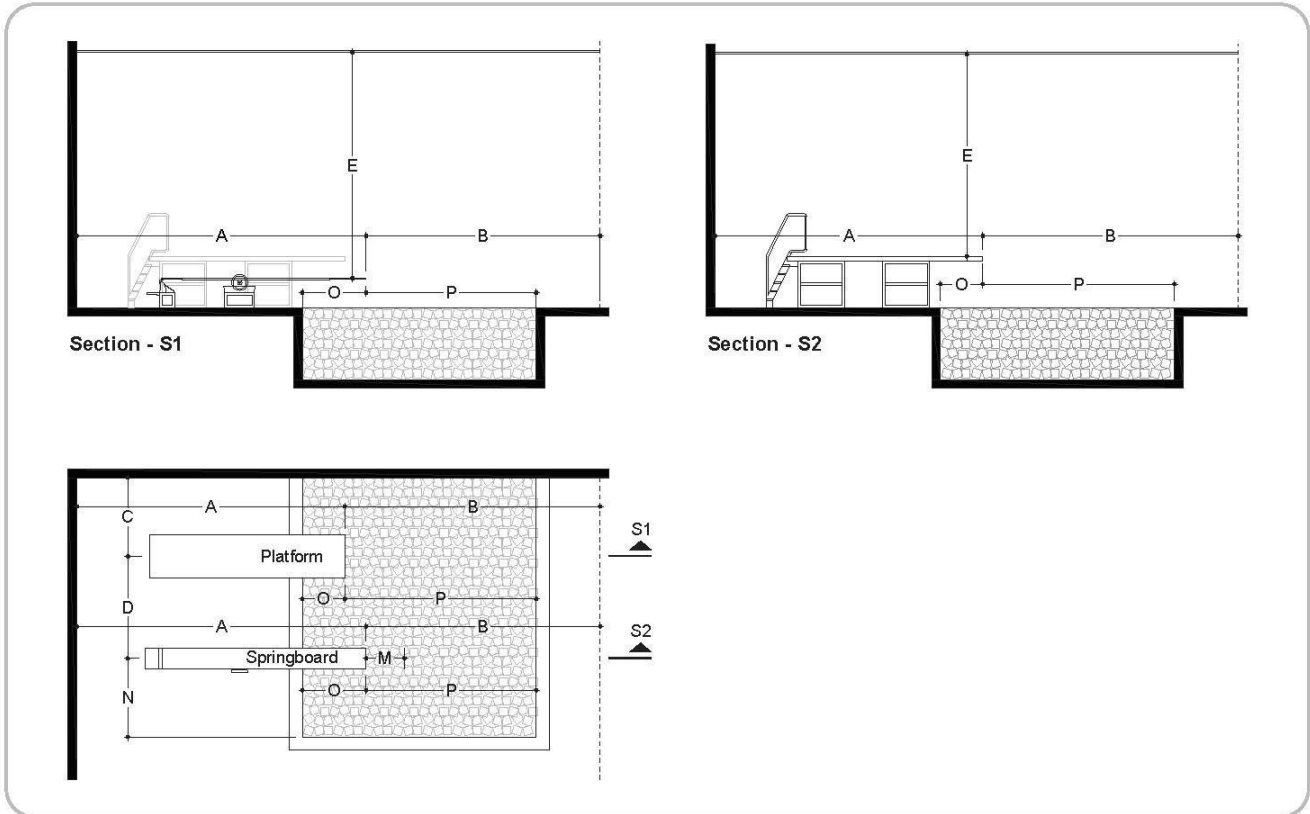
Diving Dry Land Equipment

1. Block Foam Land Pit
2. Landing Foam Pit
3. Pit*
4. Mat
5. Gymnastics Spring Floor
6. Padded Platform Bench
7. Trampoline Bed

*Minimum Pit Depth= 0.60m
(Depends on Springboard Supplier)

13.5.5 Appendix 5- Diagram Diving Dry Land Facilities Details



13.5.6 Appendix 6- Table Diving Dry land Facilities

| Diving Dry Land Facilities Design Guidelines | | Springboard | | Platform | | |
|---|---|-------------|----------|------------|----------|-------|
| | | Length | 4.88 | | Varies | |
| | | Width | 0.50 | | Varies | |
| | | Height | 1.24 | | Varies | |
| | | Horizontal | Vertical | Horizontal | Vertical | |
| A | From plumbet Back to Building Wall | Designation | A-1 | | A-PL | |
| | | Minimum | 4.88 | | Varies | |
| | | Preferred | 6.10 | | Infinity | |
| B | From plumbet to Building Wall at Ahead | Designation | B-1 | | B-PL | |
| | | Minimum | 3.66 | | 3.66 | |
| | | Preferred | Infinity | | Infinity | |
| C | From plumbet to Building Wall at Side | Designation | C-1 | | C-PL | |
| | | Minimum | 1.83 | | 1.83 | |
| | | Preferred | Infinity | | Infinity | |
| D | From plumbet to Adjacent Plumbet | Designation | D-1 | | D-PL | |
| | | Minimum | 2.00 | | 2.00 | |
| | | Preferred | 2.40 | | 2.40 | |
| E | On plumbet from Board to Ceiling | Designation | | E-1 | | E-PL |
| | | Minimum | | 5.00 | | 2.70 |
| | | Preferred | | 6.40 | | 6.40 |
| F | Clear Overhead behind and each side of plumbet | Designation | F-1 | F-1 | F-PL | F-PL |
| | | Minimum | 2.50 | 4.50 | 1.50 | 2.70 |
| | | Preferred | Varies | 6.40 | Varies | 6.40 |
| G | Clear Overhead ahead of plumbet | Designation | G-1 | G-1 | G-PL | G-PL |
| | | Minimum | 5.00 | 4.50 | 1.50 | 2.70 |
| | | Preferred | Varies | 6.40 | Varies | 6.40 |
| H | Width or Landing Pit in front of plumbet | Designation | H-1 | | H-PL | |
| | | Minimum | 1.83 | | 1.50 | |
| | | Preferred | Varies | | Varies | |
| J | Length or Landing Pit in front of plumbet | Designation | J-1 | | J-PL | |
| | | Minimum | 3.66 | | 1.50 | |
| | | Preferred | Varies | | Varies | |
| K | Angle or Spotting Rig Ropes | Designation | | K-1 | | K-PL |
| | | Minimum | | 30° | | 30° |
| | | Preferred | | 30° ± | | 30° ± |
| L | Height or Spotting Rig above diving board or platform | Designation | | L-1 | | L-PL |
| | | Minimum | | 4.50 | | 4.50 |
| | | Preferred | | 6.40 | | 6.40 |
| M | Distance in front of Plumbet to Spotting Rig | Designation | M-1 | | M-PL | |
| | | Minimum | 0.76 | | 0.76 | |
| | | Preferred | 0.91 | | 0.91 | |
| N | From plumbet to Pit Wall at Side | Designation | N-1 | | N-PL | |
| | | Minimum | 1.83 | | 1.83 | |
| | | Preferred | Infinity | | Infinity | |
| O | Overhanging | Designation | O-1 | | O-PL | |
| | | Minimum | 1.50 | | 1.00 | |
| | | Preferred | 1.50 | | 1.00 | |
| P | From Plumbet to Pit Wall at Ahead | Designation | P-1 | | P-PL | |
| | | Minimum | 4.00 | | 3.66 | |
| | | Preferred | Infinity | | Infinity | |

Use and installation guidelines for dry land facilities with in ground and above ground trampolines.

Installation and use instructions for trampolines and related equipment, such as frame pads, mats, end decks, and spotting systems, shall be provided by the manufacturer and shall specify the minimum safe area dimensions required for each trampoline type and relating their products to centre or edge of the trampoline.

Clearance (trampolines): users should refer to the manufacturer's specifications for all clearance, which may vary depending upon the manufacturer, the size of the trampoline, the type of bed in place, the type of spotting system in place, if any, and other variables. In any event, adequate space should be provided so that intended users and equipment will not come into contact with any obstacles during their anticipated use of the equipment. *i.e., bottoming out a trampoline or dry land diving board.

Clearance (platforms): these specifications apply to facilities used by AQUA level international athletes. Other specifications may be appropriate for junior or development programs, so long as adequate space is provided so that intended users and equipment will not come into contact with any obstacle during their anticipated use of the equipment.

Caution: The specifications within this page should be carefully considered in relation to the design of the dryland training site, and all safety aspects should be thoroughly evaluated.

13.5.7 Appendix 7- Equipment in Dry Land Facilities

| Recommended Equipment in Dry Land Facility | | | | | | | |
|---|---------------------------------------|--|-----------|----|----------------------|-------------|-------------|
| | | | Number | | Suggested dimensions | | |
| 1 | Diving Boards | Springboard as FR 5.1.1 mounted on diving stands with movable fulcrums. | Minimum | 2 | | | |
| | | | Preferred | 4 | | | |
| 2 | Diving Board Landing Pads | Foam landing pads for Dry land diving boards are located in front of the diving boards | Minimum | 2 | Floor | Width | Length |
| | | | Preferred | 4 | 120 cm | 1.50 m min. | 1.50 m min. |
| 3 | Trampolines | | Minimum | 1 | | | |
| | | | Preferred | 3 | | | |
| 4 | Foam Crash Mats | | Minimum | 2 | Height | Width | Length |
| | | | Preferred | 4 | 22 cm | 2 m | 3 m |
| 5 | Somersault Boxes | | Minimum | 2 | Height | Width | Length |
| | | | Preferred | 4 | 32 cm | 1 m | 1 m |
| 6 | Stretching Mats | | Minimum | 12 | Height | Width | Length |
| | | | Preferred | 24 | 12 cm | 1 m | 2 m |
| 7 | Large Mirrors | Should be placed on walls so divers can observe body movements while training on equipment. | | | | | |
| 8 | Video Replay System (Similar to TIVO) | With at least 2 cameras and 2 monitors. This allows divers to review acrobatic skills performed on springboard and trampoline. | | | | | |
| 9 | Weight Lifting Equipment | Combination of free weights and weight lifting machines. | | | | | |
| 10 | Cardio Conditioning Equipment | Treadmills and stationary bicycles. | | | | | |
| * Please note: Foam crash mats may be stacked to a height of 120 cm for the foam landing pads, or Foam pits maybe used instead of landing pads. | | | | | | | |

14. MEDICAL AND SAFETY SPECIFIC REQUIREMENT FOR DIVING

The Medical Requirements are described in the section I.9.2. However, each sport has unique components.

14.1 Location of the FoP First Aid Treatment Area

When possible, the Field of Play (FoP) First Aid Treatment Area should be positioned where athletes exit.

14.2 Water Rescue and Lifeguards

The lifeguards at the competitions shall be experienced in deep water rescue and in the management of suspected cervical spine injury. It may happen that the diver hits the board/the platform, or land horizontally, causing a wide of severe injuries that requires a special technique to protect the cervical spine. Three (3) lifeguards are required.

14.2.1 During Trainings

The 3 lifeguards shall be located on the different sides of the pool to cover a maximum of the training area.

Diagram A – Example of lifeguards location

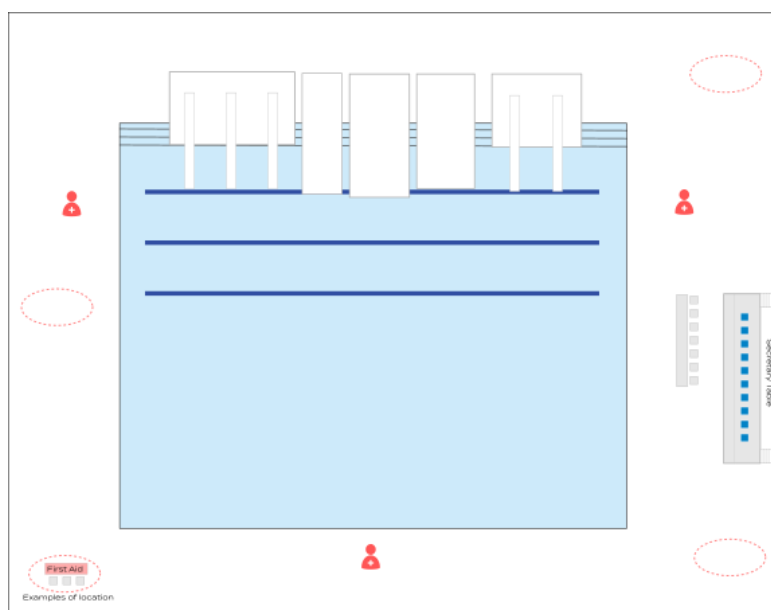

14.2.2 During Competition

During the Competition, two (2) lifeguards must be positioned on the side of the Event (e.g on the side of the 3m springboard). The third lifeguard shall be located on the other side of the pool.

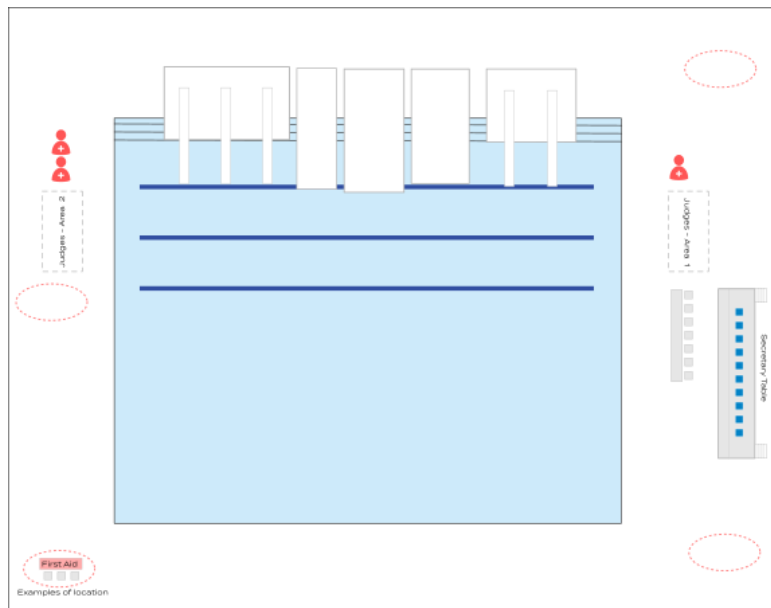

14.2.3 Dry Land

A first-aid responder shall be present in the dry land area and be connected to the FOP Medical Response Team.

15. APPENDICES

15.1 Appendix 8 – Springboard

World Aquatics Degree of difficulty – Formula and components

Note: Degree of Difficulty (DD) is calculated by adding: $A + B + C + D + E = DD$

A. Somersaults

| Level / Somersault | 0 | 1/2 | 1 | 1 1/2 | 2 | 2 1/2 | 3 | 3 1/2 | 4 | 4 1/2 |
|--------------------|-----|-----|-----|-------|-----|-------|-----|-------|-----|-------|
| 1m | 0.9 | 1.1 | 1.2 | 1.6 | 2.0 | 2.4 | 2.7 | 3.0 | 3.3 | 3.8 |
| 3m | 1.0 | 1.3 | 1.3 | 1.5 | 1.8 | 2.2 | 2.3 | 2.8 | 2.9 | 3.5 |

B. Flight Position For flying dives add fly position (E) to either (B) or (C) Position

| 0 - 1 Somersault | 1 1/2 - 2 Somersaults | 2 1/2 Somersaults | 3 - 3 1/2 Somersaults | 4 - 4 1/2 Somersaults |
|------------------|-----------------------|-------------------|-----------------------|-----------------------|
|------------------|-----------------------|-------------------|-----------------------|-----------------------|

| | Fwd | Back | Rev | Inw | Fwd | Back | Rev | Inw | Fwd | Back | Rev | Inw | Fwd | Back | Rev | Inw | Fwd | Back | Rev | Inw |
|-----------------|-----|------|-----|------|-----|------|-----|-----|-----|------|------|-----|-----|------|-----|-----|-----|------|-----|-----|
| C = Tuck | 0.1 | 0.1 | 0.1 | -0.3 | 0 | 0 | 0 | 0.1 | 0 | 0.1 | 0 | 0.2 | 0 | 0 | 0 | 0.3 | 0 | 0.1 | 0.2 | 0.4 |
| B = Pike | 0.2 | 0.2 | 0.2 | -0.2 | 0.1 | 0.3 | 0.3 | 0.3 | 0.2 | 0.3 | 0.2 | 0.5 | 0.3 | 0.3 | 0.3 | 0.6 | 0.4 | 0.4 | 0.5 | 0.8 |
| A = Str | 0.3 | 0.3 | 0.3 | 0.1 | 0.4 | 0.5 | 0.6 | 0.8 | 0.6 | 0.7 | 0.6 | - | - | - | - | - | - | - | - | - |
| D = Free | 0.1 | 0.1 | 0.1 | -0.1 | 0 | -0.1 | 0.1 | 0.2 | 0 | -0.1 | -0.2 | 0.4 | 0 | 0 | 0 | - | - | - | - | - |
| E = Fly | 0.2 | 0.1 | 0.1 | 0.4 | 0.2 | 0.2 | 0.2 | 0.5 | 0.3 | 0.3 | 0.3 | 0.7 | 0.4 | - | - | - | - | - | - | - |

Seven of the above components have **negative** values. Dashes indicate dives that currently are not possible.

c. Twists

| Group | 1/2 Twist 1/2 - 1 Som. | 1/2 Twist 1 1/2 - 2 Som. | 1/2 Twist 2 1/2 Som. | 1/2 Twist 3 - 3 1/2 Som. | 1 Twist | 1 1/2 Twists 1/2 - 2 Som. | 1 1/2 Twists 2 1/2 - 3 1/2 Som. | 2 Twists | 2 1/2 Twist 1/2 - 2 Som. | 2 1/2 Twists 2 1/2 - 3 1/2 Som. | 3 Twists | 3 1/2 Twists | 4 Twists | 4 1/2 Twists |
|-------------|---------------------------------|-----------------------------------|-------------------------------|-----------------------------------|------------|------------------------------------|--|-------------|-----------------------------------|--|-------------|-----------------|-------------|-----------------|
| Fwd. | 0.4 | 0.4 | 0.4 | 0.4 | 0.6 | 0.8 | 0.8 | 1.0 | 1.2 | 1.2 | 1.5 | 1.6 | 1.9 | 2.0 |
| Back | 0.2 | 0.4 | 0 | 0 | 0.4 | 0.8 | 0.7 | 0.8 | 1.2 | 1.1 | 1.4 | 1.7 | 1.8 | 2.1 |
| Rev. | 0.2 | 0.4 | 0 | 0 | 0.4 | 0.8 | 0.6 | 0.8 | 1.2 | 1.0 | 1.4 | 1.8 | 1.8 | 2.1 |
| Inw. | 0.2 | 0.4 | 0.2 | 0.4 | 0.4 | 0.8 | 0.8 | 0.8 | 1.2 | 1.2 | 1.5 | 1.6 | 1.9 | 2.0 |

- (1) Dives with 1/2 somersault and twists can only be executed in positions A, B, or C,
- (2) Dives with 1 or 1 1/2 somersaults and twists can only be executed in position D,
- (3) Dives with 2 or more somersaults and twists can only be executed in positions B or C

d. Approach

| Level | Forward 1/2 - 3 1/2 Som. | Forward 4 - 4 1/2 Som. | Back 1/2 - 3 Som. | Back 3 1/2 - 4 1/2 Som. | Reverse 1/2 - 3 Som. | Reverse 3 1/2 - 4 1/2 Som. | Inward 1/2 - 1 Som. | Inward 1 1/2 - 4 1/2 Som. |
|-------|--------------------------------|------------------------------|-------------------------|-------------------------------|----------------------------|----------------------------------|---------------------------|---------------------------------|
| | | | | | | | | |

| | | | | | | | | |
|-----------|---|-----|-----|-----|-----|-----|-----|-----|
| 1m | 0 | 0.5 | 0.2 | 0.6 | 0.3 | 0.5 | 0.6 | 0.5 |
| 3m | 0 | 0.3 | 0.2 | 0.4 | 0.3 | 0.3 | 0.3 | 0.3 |

E. Unnatural Entry (does not apply to twisting dives)

| Group | ½ Som. | 1 Som. | 1½ Som. | 2 Som. | 2½ Som. | 3 Som. | 3½ Som. | 4 Som. | 4½ Som. |
|-------------------------|---------------|---------------|----------------|---------------|----------------|---------------|----------------|---------------|----------------|
| Forward / Inward | - | 0.1 | - | 0.2 | - | 0.2 | - | 0.2 | - |
| Back / Reverse | 0.1 | - | 0.2 | - | 0.3 | - | 0.4 | - | 0.4 |

A value indicates the diver does not see the water before the entry. The component is the same at all levels. (-) indicates the diver does see the water before the entry. The component is the same at all levels.

Examples

| Dive | Pos | Height | A | B | C | D | E | DD |
|-------------|------------|---------------|----------|----------|----------|----------|----------|------------|
| 207 | B | 3 | 2.8 | 0.3 | 0.0 | 0.4 | 0.4 | 3.9 |
| 207 | C | 3 | 2.8 | 0.0 | 0.0 | 0.4 | 0.4 | 3.6 |
| 5253 | B | 3 | 2.3 | 0.7 | 0.0 | 0.2 | 0.0 | 3.4 |
| 5355 | B | 3 | 2.2 | 0.2 | 1.0 | 0.2 | 0.0 | 3.7 |

| Div | Pos | Height | A | B | C | D | E | DD |
|-------------|------------|---------------|----------|----------|----------|----------|----------|------------|
| 309 | B | 3 | 3.5 | 0.5 | 0.0 | 0.3 | 0.4 | 4.7 |
| 309 | C | 3 | 3.5 | 0.2 | 0.0 | 0.3 | 0.4 | 4.4 |
| 5255 | B | 3 | 2.2 | 0.3 | 1.1 | 0.2 | 0.0 | 3.8 |
| 313 | C | 3 | 1.5 | 0.2 | 0.0 | 0.3 | 0.2 | 2.2 |

15.2 Appendix 9 – Springboard

World Aquatics Table of Degree of difficulty

In the following table, a dive with (-) is not possible and dives with empty spaces have not been calculated.

| SPRINGBOARD | | 1 METER | | | | 3 METER | | | |
|---------------|-------------------------------|---------|------|----------|----------|---------|------|----------|----------|
| | | STR | PIKE | TUC K | FRE E | STR | PIKE | TUC K | FRE E |
| Forward Group | | A | B | C | D | A | B | C | D |
| 101 | Forward Dive | 1.4 | 1.3 | 1.2 | - | 1.6 | 1.5 | 1.4 | - |
| 102 | Forward Somersault | 1.6 | 1.5 | 1.4 | - | 1.7 | 1.6 | 1.5 | - |
| 103 | Forward 1½ Somersaults | 2.0 | 1.7 | 1.6 | - | 1.9 | 1.6 | 1.5 | - |
| 104 | Forward 2 Somersaults | 2.6 | 2.3 | 2.2 | - | 2.4 | 2.1 | 2.0 | - |
| 105 | Forward 2½ Somersaults | | 2.6 | 2.4 | - | 2.8 | 2.4 | 2.2 | - |
| 106 | Forward 3 Somersaults | | 3.2 | 2.9 | - | | 2.8 | 2.5 | - |
| 107 | Forward 3½ Somersaults | | 3.3 | 3.0 | - | | 3.1 | 2.8 | - |
| 108 | Forward 4 Somersaults | | | 4.0 | - | | 3.8 | 3.4 | - |
| 109 | Forward 4½ Somersaults | | | 4.3 | - | | 4.2 | 3.8 | - |
| 112 | Forward Flying Somersault | - | 1.7 | 1.6 | - | - | 1.8 | 1.7 | - |
| 113 | Forward Flying 1½ Somersaults | - | 1.9 | 1.8 | - | - | 1.8 | 1.7 | - |

| | | | | | | | | | |
|----------------------|-------------------------------------|----------|----------|----------|----------|----------|----------|----------|----------|
| 115 | Forward Flying 2½ Somersaults | - | | | - | - | 2.7 | 2.5 | - |
| Back Group | | | | | | | | | |
| | | A | B | C | D | A | B | C | D |
| 201 | Back Dive | 1.7 | 1.6 | 1.5 | - | 1.9 | 1.8 | 1.7 | - |
| 202 | Back Somersault | 1.7 | 1.6 | 1.5 | - | 1.8 | 1.7 | 1.6 | - |
| 203 | Back 1½ Somersaults | 2.5 | 2.3 | 2.0 | - | 2.4 | 2.2 | 1.9 | - |
| 204 | Back 2 Somersaults | | 2.5 | 2.2 | - | 2.5 | 2.3 | 2.0 | - |
| 205 | Back 2½ Somersaults | | 3.2 | 3.0 | - | | 3.0 | 2.8 | - |
| 206 | Back 3 Somersaults | | 3.2 | 2.9 | - | | 2.8 | 2.5 | - |
| 207 | Back 3½ Somersaults | | | | - | | 3.9 | 3.6 | - |
| 208 | Back 4 Somersaults | | | | - | | 3.7 | 3.4 | - |
| 209 | Back 4½ Somersaults | | | | - | | 4.7 | 4.4 | - |
| 212 | Back Flying Somersault | - | 1.7 | 1.6 | - | - | 1.8 | 1.7 | - |
| 213 | Back Flying 1½ Somersaults | - | | | - | - | 2.4 | 2.1 | - |
| 215 | Back Flying 2½ Somersaults | - | | | - | - | 3.3 | 3.1 | - |
| Reverse Group | | | | | | | | | |
| | | A | B | C | D | A | B | C | D |

| | | | | | | | | | |
|---------------------|-------------------------------|----------|----------|----------|----------|----------|----------|----------|----------|
| 301 | Reverse Dive | 1.8 | 1.7 | 1.6 | - | 2.0 | 1.9 | 1.8 | - |
| 302 | Reverse Somersault | 1.8 | 1.7 | 1.6 | - | 1.9 | 1.8 | 1.7 | - |
| 303 | Reverse 1½ Somersaults | 2.7 | 2.4 | 2.1 | - | 2.6 | 2.3 | 2.0 | - |
| 304 | Reverse 2 Somersaults | 2.9 | 2.6 | 2.3 | - | 2.7 | 2.4 | 2.1 | - |
| 305 | Reverse 2½ Somersaults | | 3.2 | 3.0 | - | 3.4 | 3.0 | 2.8 | - |
| 306 | Reverse 3 Somersaults | | 3.3 | 3.0 | - | | 2.9 | 2.6 | - |
| 307 | Reverse 3½ Somersaults | | | | - | | 3.8 | 3.5 | - |
| 308 | Reverse 4 Somersaults | | | | - | | 3.7 | 3.4 | - |
| 309 | Reverse 4½ Somersaults | | | | - | | 4.7 | 4.4 | - |
| 312 | Reverse Flying Somersault | - | 1.8 | 1.7 | - | - | 1.9 | 1.8 | - |
| 313 | Reverse Flying 1½ Somersaults | - | 2.6 | 2.3 | - | - | 2.5 | 2.2 | - |
| Inward Group | | | | | | | | | |
| | | A | B | C | D | A | B | C | D |
| 401 | Inward Dive | 1.8 | 1.5 | 1.4 | - | 1.7 | 1.4 | 1.3 | - |
| 402 | Inward Somersault | 2.0 | 1.7 | 1.6 | - | 1.8 | 1.5 | 1.4 | - |
| 403 | Inward 1½ Somersaults | | 2.4 | 2.2 | - | | 2.1 | 1.9 | - |
| 404 | Inward 2 | | 3.0 | 2.8 | - | | 2.6 | 2.4 | - |

| | | | | | | | | | |
|-----|------------------------------------|---|-----|-----|---|---|-----|-----|----|
| | Somersaults | | | | | | | | |
| 405 | Inward 2½ Somersaults | | 3.4 | 3.1 | - | | 3.0 | 2.7 | - |
| 407 | Inward 3½ Somersaults | | | | - | | 3.7 | 3.4 | - |
| 409 | Inward 4½ Somersaults | | | | - | | 4.6 | 4.2 | -- |
| 412 | Inward Flying Somersault | - | 2.1 | 2.0 | - | - | 1.9 | 1.8 | - |
| 413 | Inward Flying 1½ Somersaults | - | 2.9 | 2.7 | - | - | 2.6 | 2.4 | - |

| | | 1 METER | | | | 3 METER | | | |
|-----------------------|-----------------------------------|----------|----------|----------|----------|----------|----------|----------|----------|
| Twisting Group | | A | B | C | D | A | B | C | D |
| 5111 | Forward Dive ½ Twist | 1.8 | 1.7 | 1.6 | - | 2.0 | 1.9 | 1.8 | - |
| 5112 | Forward Dive 1 Twist | 2.0 | 1.9 | | - | 2.2 | 2.1 | | - |
| 5121 | Forward Somersault ½ Twist | - | - | - | 1.7 | - | - | - | 1.8 |
| 5122 | Forward Somersault 1 Twist | - | - | - | 1.9 | - | - | - | 2.0 |
| 5124 | Forward Somersault 2 Twists | - | - | - | 2.3 | - | - | - | 2.4 |
| 5126 | Forward Somersault 3 Twists | - | - | - | 2.8 | - | - | - | 2.9 |

| | | | | | | | | | |
|------|---------------------------------------|-----|-----|-----|-----|-----|-----|-----|-----|
| 5131 | Forward 1½ Somersaults ½ Twist | - | - | - | 2.0 | - | - | - | 1.9 |
| 5132 | Forward 1½ Somersaults 1 Twist | - | - | - | 2.2 | - | - | - | 2.1 |
| 5134 | Forward 1½ Somersaults 2 Twists | - | - | - | 2.6 | - | - | - | 2.5 |
| 5136 | Forward 1½ Somersaults 3 Twists | - | - | - | 3.1 | - | - | - | 3.0 |
| 5138 | Forward 1½ Somersaults 4 Twists | - | - | - | 3.5 | - | - | - | 3.4 |
| 5151 | Forward 2½ Somersaults ½ Twist | - | 3.0 | 2.8 | - | - | 2.8 | 2.6 | - |
| 5152 | Forward 2½ Somersaults 1 Twist | - | 3.2 | 3.0 | - | - | 3.0 | 2.8 | - |
| 5154 | Forward 2½ Somersaults 2 Twists | - | 3.6 | 3.4 | - | - | 3.4 | 3.2 | - |
| 5156 | Forward 2½ Somersaults 3 Twists | - | | | - | - | 3.9 | 3.7 | - |
| 5172 | Forward 3½ Somersaults 1 Twist | - | | | - | - | 3.7 | 3.4 | - |
| | | | | | | | | | |
| 5211 | Back Dive ½ Twist | 1.8 | 1.7 | 1.6 | - | 2.0 | 1.9 | 1.8 | - |

| | | | | | | | | | |
|------|------------------------------------|-----|-----|-----|-----|-----|-----|-----|-----|
| 5212 | Back Dive 1 Twist | 2.0 | | | - | 2.2 | | | - |
| 5221 | Back Somersault ½ Twist | - | - | - | 1.7 | - | - | - | 1.8 |
| 5222 | Back Somersault 1 Twist | - | - | - | 1.9 | - | - | - | 2.0 |
| 5223 | Back Somersault 1½ Twists | - | - | - | 2.3 | - | - | - | 2.4 |
| 5225 | Back Somersault 2½ Twists | - | - | - | 2.7 | - | - | - | 2.8 |
| 5227 | Back Somersault 3½ Twists | - | - | - | 3.2 | - | - | - | 3.3 |
| 5231 | Back ½ Somersaults ½ Twist | - | - | - | 2.1 | - | - | - | 2.0 |
| 5233 | Back ½ Somersaults 1½ Twists | - | - | - | 2.5 | - | - | - | 2.4 |
| 5235 | Back ½ Somersaults 2½ Twists | - | - | - | 2.9 | - | - | - | 2.8 |
| 5237 | Back ½ Somersaults 3½ Twists | - | - | - | - | - | - | - | 3.3 |
| 5239 | Back ½ Somersaults 4½ Twists | - | - | - | - | - | - | - | 3.7 |
| 5251 | Back 2½ | - | 2.9 | 2.7 | - | - | 2.7 | 2.5 | - |

| | | | | | | | | | |
|------|--|-----|-----|-----|-----|-----|-----|-----|-----|
| | Somersaults ½ Twist | | | | | | | | |
| 5253 | Back 2½ Somersaults 1½ Twists | - | | | - | - | 3.4 | 3.2 | - |
| 5255 | Back 2½ Somersaults 2½ Twists | - | | | - | - | 3.8 | 3.6 | - |
| | | | | | | | | | |
| 5311 | Reverse Dive ½ Twist | 1.9 | 1.8 | 1.7 | - | 2.1 | 2.0 | 1.9 | - |
| 5312 | Reverse Dive 1 Twist | 2.1 | | | - | 2.3 | | | - |
| 5321 | Reverse Somersault ½ Twist | - | - | - | 1.8 | - | - | - | 1.9 |
| 5322 | Reverse Somersault 1 Twist | - | - | - | 2.0 | - | - | - | 2.1 |
| 5323 | Reverse Somersault 1½ Twists | - | - | - | 2.4 | - | - | - | 2.5 |
| 5325 | Reverse Somersault 2½ Twists | - | - | - | 2.8 | - | - | - | 2.9 |
| 5331 | Reverse 1½ Somersaults ½ Twist | - | - | - | 2.2 | - | - | - | 2.1 |
| 5333 | Reverse 1½ Somersaults 1½ Twists | - | - | - | 2.6 | - | - | - | 2.5 |
| 5335 | Reverse 1½ Somersaults | - | - | - | 3.0 | - | - | - | 2.9 |

| | | | | | | | | | |
|------|---|-----|-----|-----|-----|-----|-----|-----|-----|
| | 2½ Twists | | | | | | | | |
| 5337 | Reverse 1½ Somersaults 3½ Twists | - | - | - | 3.6 | - | - | - | 3.5 |
| 5339 | Reverse 1½ Somersaults 4½ Twists | - | - | - | - | - | - | - | 3.8 |
| 5351 | Reverse 2½ Somersaults ½ Twist | - | 2.9 | 2.7 | - | - | 2.7 | 2.5 | - |
| 5353 | Reverse 2½ Somersaults 1½ Twists | - | 3.5 | 3.3 | - | - | 3.3 | 3.1 | - |
| 5355 | Reverse 2½ Somersaults 2½ Twists | - | 3.9 | 3.7 | - | - | 3.7 | 3.5 | - |
| 5371 | Reverse 3½ Somersaults ½ Twist | - | | | - | - | 3.4 | 3.1 | - |
| 5373 | Reverse 3½ Somersaults 1½ Twists | - | | | - | - | | 3.7 | - |
| 5375 | Reverse 3½ Somersaults 2 ½ Twists | - | | | - | - | | 4.1 | - |
| | | | | | | | | | |
| 5411 | Inward Dive ½ Twist | 2.0 | 1.7 | 1.6 | - | 1.9 | 1.6 | 1.5 | - |
| 5412 | Inward Dive 1 Twist | 2.2 | 1.9 | 1.8 | - | 2.1 | 1.8 | 1.7 | - |
| 5421 | Inward Somersault ½ | - | - | - | 1.9 | - | - | - | 1.7 |

| | | | | | | | | | |
|------|--------------------------------|---|---|---|-----|---|---|---|-----|
| | Twist | | | | | | | | |
| 5422 | Inward Somersault 1 Twist | - | - | - | 2.1 | - | - | - | 1.9 |
| 5432 | Inward 1½ Somersaults 1 Twist | - | - | - | 2.7 | - | - | - | 2.4 |
| 5434 | Inward 1½ Somersaults 2 Twists | - | - | - | 3.1 | - | - | - | 2.8 |
| 5436 | Inward 1½ Somersaults 3 Twists | - | - | - | | - | - | - | 3.5 |

15.3 Appendix 10 – Platform

World Aquatics Degree of difficulty – Formula and components

Note: Degree of Difficulty (DD) is calculated by adding: A + B + C + D + E = DD

A. Somersaults

| Level | 0 | ½ | 1 | 1½ | 2 | 2½ | 3 | 3½ | 4 | 4½ | 5½ |
|-------|-----|-----|-----|-----|-----|-----|-----|-----|-----|-----|-----|
| 5m | 0.9 | 1.1 | 1.2 | 1.6 | 2.0 | 2.4 | 2.7 | 3.0 | - | - | - |
| 7½m | 1.0 | 1.3 | 1.3 | 1.5 | 1.8 | 2.2 | 2.3 | 2.8 | 3.5 | 3.5 | - |
| 10m | 1.0 | 1.3 | 1.4 | 1.5 | 1.9 | 2.1 | 2.5 | 2.7 | 3.5 | 3.5 | 4.5 |

B. Flight Position

For flying dives add fly position (E) to either (B) or (C) Position

| | 0 - 1 Somersault | | | | | 1½ - 2 Somersaults | | | | | 2½ Somersaults | | | | | 3 - 3½ Somersaults | | | | |
|-----------------|------------------|-------|-----|------|-----|--------------------|-------|-----|-----|-----|----------------|-------|-----|-----|-----|--------------------|-------|-----|-----|-----|
| | Fwd | Bac k | Rev | Inw | Arm | Fwd | Bac k | Rev | Inw | Arm | Fwd | Bac k | Rev | Inw | Arm | Fwd | Bac k | Rev | Inw | Arm |
| C = Tuck | 0.1 | 0.1 | 0.1 | -0.3 | 0.1 | 0 | 0 | 0 | 0.1 | 0 | 0 | 0.1 | 0 | 0.2 | 0.1 | 0 | 0 | 0 | 0.3 | 0.2 |

| | | | | | | | | | | | | | | | | | | | | |
|-----------------|-----|-----|-----|------|-----|-----|------|------|-----|-----|-----|------|------|-----|---|-----|-----|-----|-----|-----|
| B = Pike | 0.2 | 0.2 | 0.2 | -0.2 | 0.3 | 0.1 | 0.3 | 0.3 | 0.3 | 0.3 | 0.2 | 0.3 | 0.2 | 0.5 | 0 | 0.3 | 0.3 | 0.3 | 0.6 | 0.4 |
| A = Str | 0.3 | 0.3 | 0.3 | 0.1 | 0.4 | 0.4 | 0.5 | 0.6 | 0.8 | 0.5 | 0.6 | 0.7 | 0.6 | - | - | - | - | - | - | - |
| D = Free | 0.1 | 0.1 | 0.1 | -0.1 | 0 | 0 | -0.1 | -0.1 | 0.2 | 0 | 0 | -0.1 | -0.2 | 0.4 | 0 | 0 | 0 | 0 | - | - |
| E = Fly | 0.2 | 0.1 | 0.1 | 0.4 | - | 0.2 | 0.2 | 0.2 | 0.5 | - | 0.3 | 0.3 | 0.3 | 0.7 | - | 0.4 | - | - | - | - |

| | 4 - 4½ Somersaults | | | | | 5½ Som |
|-----------------|---------------------------|-------------|------------|------------|------------|---------------|
| | Fwd | Back | Rev | Inw | Arm | Fwd |
| C = Tuck | 0 | 0.1 | 0.3 | 0.4 | 0.3 | 0 |
| B = Pike | 0.4 | 0.4 | 0.6 | 0.7 | 0.5 | - |
| A = Str | - | - | - | - | - | - |
| D = Free | - | - | - | - | - | - |
| E = Fly | - | - | - | - | - | - |

Seven of the above components have **negative** values. Dashes indicate dives that currently are not possible.

c. Twists

| Group | ½ Twist ½ - 1 Som. | ½ Twist 1½ - 2 Som. | ½ Twist 2½ Som. | ½ Twist 3 - 3½ Som. | 1 Twist Twist Som. | 1½ Twist s ½ - 2 Som. | 1½ Twist s 2½ - 3½ Som. | 2 Twist s Twist Som. | 2½ Twists ½ - 2 Som. | 2½ Twist s 2½ - 3½ Som. | 3 Twist s Twist Som. | 3½ Twist s ½ - 2 Som. | 3½ Twist s 2½ - 3½ Som. | 4 Twist s Twist Som. | 4½ Twist s ½ - 2 Som. | 4½ Twists 2½ - 3½ Som. |
|------------------------|-----------------------------------|------------------------------------|--------------------------------|------------------------------------|-----------------------------------|--|--|---|-------------------------------------|--|---|--|--|---|--|---------------------------------------|
| Forward | 0.4 | 0.4 | 0.4 | 0.4 | 0.6 | 0.8 | 0.8 | 1.0 | 1.2 | 1.2 | 1.5 | 1.6 | 1.6 | 1.9 | 2.0 | 2.0 |
| Back | 0.2 | 0.4 | 0 | 0 | 0.4 | 0.8 | 0.6 | 0.8 | 1.2 | 1.0 | 1.4 | 1.7 | 1.5 | 1.8 | 2.1 | 1.9 |
| Reverse | 0.2 | 0.4 | 0 | 0 | 0.4 | 0.8 | 0.6 | 0.8 | 1.2 | 1.0 | 1.4 | 1.7 | 1.5 | 1.8 | 2.1 | 1.9 |
| Inward | 0.2 | 0.4 | 0.2 | 0.4 | 0.4 | 0.8 | 0.8 | 0.8 | 1.2 | 1.2 | 1.5 | 1.6 | 1.6 | 1.9 | 2.0 | 2.0 |
| Arm. Forw. | 0.4 | 0.5 | 0.5 | 0.4 | 1.2 | 1.3 | 1.3 | 1.5 | 1.7 | 1.7 | 1.9 | 2.1 | 2.1 | 2.3 | 2.5 | 2.5 |
| Arm. Back / Rev | 0.4 | 0.5 | 0.5 | 0.5 | 1.2 | 1.3 | 1.3 | 1.3 | 1.7 | 1.7 | 1.9 | 2.1 | 2.1 | 2.3 | 2.5 | 2.5 |

- (1) Dives with $\frac{1}{2}$ somersault and twists can only be executed in positions A, B, or C,
- (2) Dives with 1 or $\frac{1}{2}$ somersaults and twists can only be executed in position D,
- (3) Dives with 2 or more somersaults and twists can only be executed in positions B or C,
- (4) Armstand dives with 1, $\frac{1}{2}$, or 2 somersaults and one or more twists can only be executed in position D, and
- (5) Armstand dives with $2\frac{1}{2}$ or more somersaults and twist can only be executed in positions B or C

d. Approach Forward-, Back-, Reverse-, Inward-, and Twisting Groups

| Level | Forward $\frac{1}{2}$ - $3\frac{1}{2}$ Soms. | Forward 4 - $5\frac{1}{2}$ Soms. | Back $\frac{1}{2}$ - 3 Soms. | Back $3\frac{1}{2}$ - $4\frac{1}{2}$ Soms. | Reverse $\frac{1}{2}$ - 2 Soms. | Reverse $2\frac{1}{2}$ - 3 Soms. | Reverse $3\frac{1}{2}$ - $4\frac{1}{2}$ Soms. | Inward $\frac{1}{2}$ - 1 Soms. | Inward $1\frac{1}{2}$ - $4\frac{1}{2}$ Soms. |
|-------|--|--|------------------------------------|--|---------------------------------------|--|---|--------------------------------------|--|
| 5m | 0 | 0.5 | 0.2 | 0.5 | 0.3 | 0.4 | 0.6 | 0.6 | 0.5 |
| 7.5m | 0 | 0.3 | 0.2 | 0.3 | 0.3 | 0.4 | 0.4 | 0.3 | 0.3 |
| 10m | 0 | 0.2 | 0.2 | 0.2 | 0.3 | 0.4 | 0.3 | 0.3 | 0.2 |

D. Approach Armstand Group (Does not apply to armstand dives with twists).

| Level | Armstand Forward with 0 - 2 Soms. | Armstand Forward with more than 2 Soms | Armstand Back with 0 - $\frac{1}{2}$ Soms. | Armstand Back with 1 - 4 Soms. | Armstand Reverse with 0 - $\frac{1}{2}$ Som. | Armstand Reverse with 1 - 4 Soms. |
|-----------------------|--|--|---|---|---|--|
| 5m / 7.5m / 10m | 0.2 | 0.4 | 0.2 | 0.4 | 0.3 | 0.5 |

(Appendix 10 cont.)

E. Unnatural Entry (does not apply to twisting dives)

| Group | ½ Som. | 1 Som. | 1½ Som. | 2 Som. | 2½ Som. | 3 Som. | 3½ Som. | 4 Som. | 4½ Som. | 5½ Som. |
|--|-----------|-----------|------------|-----------|------------|-----------|------------|-----------|------------|------------|
| Forward / Inward | - | 0.1 | - | 0.2 | - | 0.2 | - | 0.0 | - | - |
| Back / Reverse | 0.1 | - | 0.2 | - | 0.3 | - | 0.4 | - | 0.4 | 0.0 |
| Armstand Back / Reverse | - | 0.1 | - | 0.2 | - | 0.2 | - | 0.3 | - | - |
| Armstand Forward | 0.1 | - | 0.2 | - | 0.3 | - | 0.4 | - | 0.4 | 0.0 |

A value indicates the diver does not see the water before the entry. The component is the same at all levels. (-) indicates the diver does see the water before the entry. The component is the same at all levels.

Examples

| Dive | Pos | Height | A | B | C | D | E | DD |
|------|-----|--------|-----|-----|-----|-----|-----|------------|
| 307 | B | 10 | 2.7 | 0.3 | 0.0 | 0.3 | 0.4 | 3.7 |
| 307 | C | 10 | 2.7 | 0.0 | 0.0 | 0.3 | 0.4 | 3.4 |
| 5371 | B | 10 | 2.7 | 0.3 | 0.0 | 0.3 | 0.0 | 3.3 |
| 5371 | B | 10 | 2.1 | 0.3 | 1.5 | 0.2 | 0.0 | 4.1 |

| Dive | Pos | Height | A | B | C | D | E | DD |
|----------|-----|--------|-----|-----|-----|-----|-----|------------|
| 309 | B | 10 | 3.5 | 0.6 | 0.0 | 0.3 | 0.4 | 4.8 |
| 309 | C | 10 | 3.5 | 0.3 | 0.0 | 0.3 | 0.4 | 4.5 |
| 5371 | C | 10 | 2.7 | 0.0 | 0.0 | 0.3 | 0.0 | 3.0 |
| 624 7 | D | 10 | 1.9 | 0.0 | 2.1 | 0.0 | 0.0 | 4.0 |

15.4 Appendix 11 – Platform

World Aquatics Table of Degree of difficulty

In the following table, a dive with (-) is not possible and dives with empty spaces have not been calculated.

| PLATFORM | | 10 METER | | | | 7.5 METER | | | | 5 METER | | | |
|---------------|-------------------------------------|----------|----------|----------|----------|-----------|----------|----------|----------|---------|----------|----------|----------|
| | | ST R | PIK E | TU CK | FR EE | ST R | PIK E | TU CK | FR EE | ST R | PIK E | TU CK | FR EE |
| Forward Group | | A | B | C | D | A | B | C | D | A | B | C | D |
| 101 | Forward Dive | 1.6 | 1.5 | 1.4 | - | 1.6 | 1.5 | 1.4 | - | 1.4 | 1.3 | 1.2 | - |
| 102 | Forward 1 Somersault | 1.8 | 1.7 | 1.6 | - | 1.7 | 1.6 | 1.5 | - | 1.6 | 1.5 | 1.4 | - |
| 103 | Forward 1½ Somersaults | 1.9 | 1.6 | 1.5 | - | 1.9 | 1.6 | 1.5 | - | 2.0 | 1.7 | 1.6 | - |
| 104 | Forward 2 Somersaults | 2.5 | 2.2 | 2.1 | - | 2.4 | 2.1 | 2.0 | - | 2.6 | 2.3 | 2.2 | - |
| 105 | Forward 2½ Somersaults | 2.7 | 2.3 | 2.1 | - | | 2.4 | 2.2 | - | | 2.6 | 2.4 | - |
| 106 | Forward 3 Somersaults | | 3.0 | 2.7 | - | | 2.8 | 2.5 | - | | 3.2 | 2.9 | - |
| 107 | Forward 3½ Somersaults | | 3.0 | 2.7 | - | | 3.1 | 2.8 | - | | | 3.0 | - |
| 108 | Forward 4 Somersaults | | 4.1 | 3.7 | - | | | | - | | | | - |
| 109 | Forward 4½ Somersaults | | 4.1 | 3.7 | - | | | | - | | | | - |
| 1011 | Forward 5½ Somersaults | | | 4.7 | - | | | | - | | | | - |
| 112 | Forward Flying Somersaults | - | 1.9 | 1.8 | - | - | 1.8 | 1.7 | - | - | 1.7 | 1.6 | - |
| 113 | Forward Flying 1½ Somersaults | - | 1.8 | 1.7 | - | - | 1.8 | 1.7 | - | - | 1.9 | 1.8 | - |
| 114 | Forward Flying 2 Somersaults | - | 2.4 | 2.3 | - | - | 2.3 | 2.2 | - | - | 2.5 | 2.4 | - |

| | | | | | | | | | | | | | |
|----------------------|-------------------------------------|----------|----------|----------|----------|----------|----------|----------|----------|----------|----------|----------|----------|
| 115 | Forward Flying 2½ Somersaults | - | 2.6 | 2.4 | - | - | | 2.5 | - | - | | | - |
| Back Group | | | | | | | | | | | | | |
| | | A | B | C | D | A | B | C | D | A | B | C | D |
| 201 | Back Dive | 1.9 | 1.8 | 1.7 | - | 1.9 | 1.8 | 1.7 | - | 1.7 | 1.6 | 1.5 | - |
| 202 | Back 1 Somersault | 1.9 | 1.8 | 1.7 | - | 1.8 | 1.7 | 1.6 | - | 1.7 | 1.6 | 1.5 | - |
| 203 | Back 1½ Somersaults | 2.4 | 2.2 | 1.9 | - | 2.4 | 2.2 | 1.9 | - | 2.5 | 2.3 | 2.0 | - |
| 204 | Back 2 Soms Somersaults | 2.6 | 2.4 | 2.1 | - | 2.5 | 2.3 | 2.0 | - | | 2.5 | 2.2 | - |
| 205 | Back 2½ Somersaults | 3.3 | 2.9 | 2.7 | - | | 3.0 | 2.8 | - | | 3.2 | 3.0 | - |
| 206 | Back 3 Somersaults | | 3.0 | 2.7 | - | | 2.8 | 2.5 | - | | 3.2 | 2.9 | - |
| 207 | Back 3½ Somersaults | | 3.6 | 3.3 | - | | | 3.5 | - | | | | - |
| 208 | Back 4 Somersaults | | 4.1 | 3.8 | - | | 4.2 | 3.9 | - | | 4.4 | 4.1 | - |
| 209 | Back 4½ Somersaults | | 4.5 | 4.2 | - | | | | - | | | | - |
| 212 | Back Flying Somersaults | - | 1.9 | 1.8 | - | - | 1.8 | 1.7 | - | - | 1.7 | 1.6 | - |
| 213 | Back Flying 1½ Somersaults | - | 2.4 | 2.1 | - | - | 2.4 | 2.1 | - | - | 2.5 | 2.2 | - |
| 215 | Back Flying 2 ½ Somersaults | - | 3.2 | 3.0 | - | - | | | - | - | | | - |
| Reverse Group | | | | | | | | | | | | | |
| | | A | B | C | D | A | B | C | D | A | B | C | D |

| | | | | | | | | | | | | | |
|---------------------|-------------------------------------|----------|----------|----------|----------|----------|----------|----------|----------|----------|----------|----------|----------|
| 301 | Reverse Dive | 2.0 | 1.9 | 1.8 | - | 2.0 | 1.9 | 1.8 | - | 1.8 | 1.7 | 1.6 | - |
| 302 | Reverse 1 Somersault | 2.0 | 1.9 | 1.8 | - | 1.9 | 1.8 | 1.7 | - | 1.8 | 1.7 | 1.6 | - |
| 303 | Reverse 1½ Somersaults | 2.6 | 2.3 | 2.0 | - | 2.6 | 2.3 | 2.0 | - | 2.7 | 2.4 | 2.1 | - |
| 304 | Reverse 2 Somersaults | 2.8 | 2.5 | 2.2 | - | 2.7 | 2.4 | 2.1 | - | 2.9 | 2.6 | 2.3 | - |
| 305 | Reverse 2½ Somersaults | 3.4 | 3.0 | 2.8 | - | 3.5 | 3.1 | 2.9 | - | | 3.3 | 3.1 | - |
| 306 | Reverse 3 Somersaults | | 3.2 | 2.9 | - | | 3.0 | 2.7 | - | | 3.4 | 3.1 | - |
| 307 | Reverse 3½ Somersaults | | 3.7 | 3.4 | - | | | | - | | | | - |
| 308 | Reverse 4 Somersaults | | 4.4 | 4.1 | - | | 4.5 | 4.2 | - | | | | - |
| 309 | Reverse 4½ Somersaults | | 4.8 | 4.5 | - | | | | - | | | | - |
| 312 | Reverse Flying Somersaults | - | 2.0 | 1.9 | - | - | 1.9 | 1.8 | - | - | 1.8 | 1.7 | - |
| 313 | Reverse Flying 1½ Somersaults | - | 2.5 | 2.2 | - | - | 2.5 | 2.2 | - | - | 2.6 | 2.3 | - |
| Inward Group | | | | | | | | | | | | | |
| | | A | B | C | D | A | B | C | D | A | B | C | D |
| 401 | Inward Dive | 1.7 | 1.4 | 1.3 | - | 1.7 | 1.4 | 1.3 | - | 1.8 | 1.5 | 1.4 | - |
| 402 | Inward 1 Somersault | 1.9 | 1.6 | 1.5 | - | 1.8 | 1.5 | 1.4 | - | 2.0 | 1.7 | 1.6 | - |
| 403 | Inward 1½ Somersault | | 2.0 | 1.8 | - | | 2.1 | 1.9 | - | | 2.4 | 2.2 | - |

| | | 10 METER | | | | 7.5 METER | | | | 5 METER | | | |
|-----------------------|---------------------------------|----------|----------|----------|----------|-----------|----------|----------|----------|----------|----------|----------|----------|
| Inward Group | | A | B | C | D | A | B | C | D | A | B | C | D |
| 404 | Inward 2 Somersaults | | 2.6 | 2.4 | - | | 2.6 | 2. 4 | - | | 3.0 | 2.8 | - |
| 405 | Inward 2½ Somersaults | | 2.8 | 2.5 | - | | 3.0 | 2. 7 | - | | 3.4 | 3.1 | - |
| 406 | Inward 3 Somersaults | | 3.5 | 3.2 | - | | 3.4 | 3.1 | - | | 4.0 | 3.7 | - |
| 407 | Inward 3½ Somersaults | | 3.5 | 3.2 | - | | | 3. 4 | - | | | | - |
| 408 | Inward 4 Somersaults | | 4.4 | 4.1 | - | | | | - | | | | - |
| 409 | Inward 4½ Somersaults | | 4.4 | 4.1 | - | | | | - | | | | - |
| 412 | Inward Flying Somersaults | - | 2.0 | 1.9 | - | - | 1.9 | 1.8 | - | - | 2.1 | 2.0 | - |
| 413 | Inward Flying 1½ Somersaults | - | 2.5 | 2.3 | - | - | 2.6 | 2. 4 | - | - | 2.9 | 2.7 | - |
| Twisting Group | | | | | | | | | | | | | |
| Twisting Group | | A | B | C | D | A | B | C | D | A | B | C | D |
| 5111 | Fwd Dive ½ Twist | 2.0 | 1.9 | 1.8 | - | 2.0 | 1.9 | 1.8 | - | 1.8 | 1.7 | 1.6 | - |
| 5112 | Fwd Dive 1 Twist | 2.2 | 2.1 | | - | 2.2 | 2.1 | | - | 2.0 | 1.9 | | - |
| 5121 | Fwd Somersault ½ Twist | - | - | - | 1.9 | - | - | - | 1.8 | - | - | - | 1.7 |
| 5122 | Fwd Somersault 1 Twist | - | - | - | 2.1 | - | - | - | 2.0 | - | - | - | 1.9 |
| 5124 | Fwd Somersault 2 Twists | - | - | - | 2.5 | - | - | - | 2.4 | - | - | - | 2.3 |
| 5131 | Fwd 1½ | - | - | - | 1.9 | - | - | - | 1.9 | - | - | - | 2.0 |

| | | | | | | | | | | | | | |
|----------|-----------------------------------|-----|-----|-----|-----|-----|-----|---------|-----|-----|-----|-----|-----|
| | Somersaults ½ Twist | | | | | | | | | | | | |
| 5132 | Fwd 1½ Somersaults 1 Twist | - | - | - | 2.1 | - | - | - | 2.1 | - | - | - | 2.2 |
| 513 4 | Fwd 1½ Somersaults 2 Twists | - | - | - | 2.5 | - | - | - | 2.5 | - | - | - | 2.6 |
| 513 6 | Fwd 1½ Somersaults 3 Twists | - | - | - | 3.0 | - | - | - | 3.0 | - | - | - | 3.1 |
| 513 8 | Fwd 1½ Somersaults 4 Twists | - | - | - | 3.4 | - | - | - | 3.4 | - | - | - | 3.5 |
| 5152 | Fwd 2½ Somersaults 1 Twist | - | 2.9 | 2.7 | - | - | 3.0 | 2. 8 | - | - | 3.2 | 3.0 | - |
| 515 4 | Fwd 2½ Somersaults 2 Twists | - | 3.3 | 3.1 | - | - | 3.4 | 3. 2 | - | - | 3.6 | 3.4 | - |
| 515 6 | Fwd 2½ Somersaults 3 Twists | - | 3.8 | 3.6 | - | - | | | - | - | | | - |
| 5172 | Fwd 3½ Somersaults 1 Twist | - | 3.6 | 3.3 | - | - | 3.7 | 3. 4 | - | - | - | - | - |
| | | | | | | | | | | | | | |
| 5211 | Back Dive ½ Twist | 2.0 | 1.9 | 1.8 | - | 2.0 | 1.9 | 1.8 | - | 1.8 | 1.7 | 1.6 | - |
| 5212 | Back Dive 1 Twist | 2.2 | | | - | 2.2 | | | - | 2.0 | | | - |
| 5221 | Back Somersault ½ | - | - | - | 1.9 | - | - | - | 1.8 | - | - | - | 1.7 |

| | | | | | | | | | | | | | |
|----------|-------------------------------------|---|-----|-----|-----|---|-----|---------|-----|---|-----|-----|-----|
| | Twist | | | | | | | | | | | | |
| 522 2 | Back Somersault 1 Twist | - | - | - | 2.1 | - | - | - | 2.0 | - | - | - | 1.9 |
| 522 3 | Back Somersault 1½ Twists | - | - | - | 2.5 | - | - | - | 2.4 | - | - | - | 2.3 |
| 522 5 | Back Somersault 2½ Twists | - | - | - | 2.9 | - | - | - | 2.8 | - | - | - | 2.7 |
| 5231 | Back 1½ Somersaults ½ Twist | - | - | - | 2.0 | - | -- | - | 2.0 | - | - | - | 2.1 |
| 523 3 | Back 1½ Somersaults 1½ Twists | - | - | - | 2.4 | - | - | - | 2.4 | - | - | - | 2.5 |
| 523 5 | Back 1½ Somersaults 2½ Twists | - | - | - | 2.8 | - | - | - | 2.8 | - | - | - | 2.9 |
| 523 7 | Back 1½ Somersaults 3½ Twists | - | - | - | 3.3 | - | - | - | 3.3 | - | - | - | 3.4 |
| 523 9 | Back 1½ Somersaults 4½ Twists | - | - | - | 3.7 | - | - | - | 3.7 | - | - | - | 3.8 |
| 5251 | Back 2½ Somersaults ½ Twist | - | 2.6 | 2.4 | - | - | 2.7 | 2. 5 | - | - | 2.9 | 2.7 | - |
| 525 3 | Back 2½ Somersaults 1½ Twists | - | 3.2 | 3.0 | - | - | 3.3 | 3.1 | - | - | | | - |
| 525 5 | Back 2½ Somersaults 2½ | - | 3.6 | 3.4 | - | - | | | - | - | | | - |

| | | | | | | | | | | | | | |
|----------|-------------------------------------|-----|-----|-----|-----|-----|-----|-----|-----|-----|-----|-----|-----|
| | Twists | | | | | | | | | | | | |
| 525 7 | Back 2½ Somersaults 3½ Twists | - | 4.1 | 3.9 | - | - | | | - | - | | | - |
| 5271 | Back 3½ Somersaults ½ Twist | - | 3.2 | 2.9 | - | - | | | - | - | | | - |
| 527 3 | Back 3½ Somersaults 1½ Twist | - | 3.8 | 3.5 | - | - | | | - | - | | | - |
| 527 5 | Back 3½ Somersaults 2½ Twist | - | 4.2 | 3.9 | - | - | | | - | - | | | - |
| | | | | | | | | | | | | | |
| 5311 | Reverse Dive ½ Twist | 2.1 | 2.0 | 1.9 | - | 2.1 | 2.0 | 1.9 | - | 1.9 | 1.8 | 1.7 | - |
| 5312 | Reverse Dive 1 Twist | 2.3 | | | - | 2.3 | | | - | 2.1 | | | - |
| 5321 | Reverse Somersault ½ Twist | - | - | - | 2.0 | - | - | - | 1.9 | - | - | - | 1.8 |
| 532 2 | Reverse Somersault 1 Twist | - | - | - | 2.2 | - | - | - | 2.1 | - | - | - | 2.0 |
| 532 3 | Reverse Somersault 1½ Twists | - | - | - | 2.6 | - | - | - | 2.5 | - | - | - | 2.4 |
| 532 5 | Reverse Somersault 2½ Twists | - | - | - | 3.0 | - | - | - | 2.9 | - | - | - | 2.8 |
| 5331 | Reverse 1½ Soms. ½ Twists | - | - | - | 2.1 | - | - | - | 2.1 | - | - | - | 2.2 |

| | | | | | | | | | | | | | |
|----------|----------------------------------|---|-----|-----|-----|---|-----|---------|-----|---|-----|-----|-----|
| 533 3 | Reverse 1½ Soms. 1½ Twists | - | - | - | 2.5 | - | - | - | 2.5 | - | - | - | 2.6 |
| 533 5 | Reverse 1½ Soms. 2½ Twists | - | - | - | 2.9 | - | - | - | 2.9 | - | - | - | 3.0 |
| 533 7 | Reverse 1½ Soms. 3½ Twists | - | - | - | 3.4 | - | - | - | 3.4 | - | - | - | 3.5 |
| 533 9 | Reverse 1½ Soms. 4½ Twists | - | - | - | 3.8 | - | - | - | 3.8 | - | - | - | - |
| 5351 | Reverse 2½ Soms. ½ Twists | - | 2.7 | 2.5 | - | - | 2.8 | 2. 6 | - | - | 3.0 | 2.8 | - |

| | | 10 METER | | | | 7.5 METER | | | | 5 METER | | | |
|-----------------------|-------------------------------|----------|----------|----------|----------|-----------|----------|----------|----------|----------|----------|----------|----------|
| Twisting Group | | A | B | C | D | A | B | C | D | A | B | C | D |
| 535 3 | Reverse 2½ Soms. 1½ Twists | - | 3.3 | 3.1 | - | - | 3.4 | 3.2 | - | - | | 3. 4 | - |
| 535 5 | Reverse 2½ Soms. 2½ Twists | - | 3.7 | 3.5 | - | - | 3.8 | 3.6 | - | - | | 3. 8 | - |
| 5371 | Reverse 3½ Soms. ½ Twists | - | 3.3 | 3.0 | - | - | | | - | - | | | - |
| 537 3 | Reverse 3½ Soms. 1½ Twist | - | | 3.6 | - | - | | | - | - | | | - |
| 537 5 | Reverse 3½ Soms. 2½ Twist | - | | 4.0 | - | - | | | - | - | | | - |
| | | | | | | | | | | | | | |
| 5411 | Inward Dive ½ Twist | 1.9 | 1.6 | 1.5 | - | 1.9 | 1.6 | 1.5 | - | 2.0 | 1.7 | 1.6 | - |
| 5412 | Inward Dive 1 Twist | 2.1 | 1.8 | 1.7 | - | 2.1 | 1.8 | 1.7 | - | 2.2 | 1.9 | 1.8 | - |

| | | | | | | | | | | | | | |
|-----------------|--------------------------------------|-----|-----|-----|-----|-----|-----|-----|-----|-----|-----|---------|-----|
| 5421 | Inward Somersault ½ Twist | - | - | - | 1.8 | - | - | - | 1.7 | - | - | - | 1.9 |
| 542 2 | Inward Somersault 1 Twist | - | - | - | 2.0 | - | - | - | 1.9 | - | - | - | 2.1 |
| 543 2 | Inward ½ Somersaults 1 Twist | - | - | - | 2.3 | - | - | - | 2.4 | - | - | - | 2.7 |
| 543 4 | Inward ½ Somersaults 2 Twists | - | - | - | 2.7 | - | - | - | 2.8 | - | - | - | 3.1 |
| 543 6 | Inward ½ Somersaults 3 Twists | - | - | - | 3.4 | - | - | - | | - | - | - | |
| Armstand Group | | | | | | | | | | | | | |
| 600 | Armstand Dive | 1.6 | - | - | - | 1.6 | - | - | - | 1.5 | - | - | - |
| 611 | Armstand Forward ½ Somersault | 2.0 | 1.9 | 1.7 | - | 2.0 | 1.9 | 1.7 | - | 1.8 | 1.7 | 1.5 | - |
| 612 | Armstand Forward 1 Somersault | 2.0 | 1.9 | 1.7 | - | 1.9 | 1.8 | 1.6 | - | 1.8 | 1.7 | 1.5 | - |
| 614 | Armstand Forward 2 Somersaults | | 2.4 | 2.1 | - | | 2.3 | 2.0 | - | | 2.5 | 2. 2 | - |
| 616 | Armstand Forward 3 Somersaults | | 3.3 | 3.1 | - | | | | - | | | | - |
| Armstand Back ½ | | | | | | | | | | | | | |
| 621 | Armstand Back ½ | 1.9 | 1.8 | 1.6 | - | 1.9 | 1.8 | 1.6 | - | 1.7 | 1.6 | 1.4 | - |

| | | | | | | | | | | | | | |
|------|-------------------------------|-----|-----|-----|-----|-----|-----|-----|-----|-----|-----|-----|-----|
| | Somersault | | | | | | | | | | | | |
| 622 | Armstand Back Somersault | 2.3 | 2.2 | 2.0 | - | 2.2 | 2.1 | 1.9 | - | 2.1 | 2.0 | 1.8 | - |
| 623 | Armstand Back 1½ Somersaults | | 2.2 | 1.9 | - | | 2.2 | 1.9 | - | | 2.3 | 2.0 | - |
| 624 | Armstand Back 2 Somersaults | 3.0 | 2.8 | 2.5 | - | 2.9 | 2.7 | 2.4 | - | 3.1 | 2.9 | 2.6 | - |
| 626 | Armstand Back 3 Somersaults | | 3.5 | 3.3 | - | | 3.3 | 3.1 | - | | | 3.5 | - |
| 628 | Armstand Back 4 Somersaults | | 4.7 | 4.5 | - | | | | - | | | | - |
| | | | | | | | | | | | | | |
| 631 | Armstand Reverse ½ Somersault | 2.0 | 1.9 | 1.7 | - | 2.0 | 1.9 | 1.7 | - | 1.8 | 1.7 | 1.5 | - |
| 632 | Armstand Reverse 1 Somersault | | 2.3 | 2.1 | - | | 2.2 | 2.0 | - | | 2.1 | 1.9 | - |
| 633 | Armstand Reverse 1½ Soms. | | 2.3 | 2.0 | - | | 2.3 | 2.0 | - | | 2.4 | 2.1 | - |
| 634 | Armstand Reverse 2 Soms. | | 2.9 | 2.6 | - | | 2.8 | 2.5 | - | | 3.0 | 2.7 | - |
| 636 | Armstand Reverse 3 Soms. | | 3.6 | 3.4 | - | | | 3.2 | - | | | | - |
| 638 | Armstand Reverse 4 Soms. | | 4.8 | 4.6 | - | | | | - | | | | - |
| | | | | | | | | | | | | | |
| 6122 | Armstand Fwd Som. 1 Twist | - | - | - | 2.6 | - | - | - | 2.5 | - | - | - | 2.4 |
| 612 | Armstand Fwd | - | - | - | 2.9 | - | - | - | 2.8 | - | - | - | 2.7 |

| | | | | | | | | | | | | | |
|----------|-----------------------------------|---|-----|-----|-----|---|-----|-----|-----|---|-----|---------|-----|
| 4 | Som. 2 Twists | | | | | | | | | | | | |
| 614 2 | Armstand Fwd 2 Soms. 1 Twist | - | - | - | 3.1 | - | - | - | 3.0 | - | - | - | 3.2 |
| 614 4 | Armstand Fwd 2 Soms. 2 Twists | - | - | - | 3.4 | - | - | - | 3.3 | - | - | - | 3.5 |
| 616 2 | Armstand Fwd 3 Soms. 1 Twist | - | | 3.9 | - | - | | | - | - | | | - |
| | | | | | | | | | | | | | |
| 6221 | Armstand Back Som. ½ Twist | - | - | - | 1.8 | - | - | - | 1.7 | - | - | - | 1.6 |
| 624 1 | Armstand Back 2 Soms. ½ Twist | - | 2.7 | 2.4 | - | - | 2.6 | 2.3 | - | - | 2.8 | 2. 5 | - |
| 624 3 | Armstand Back 2 Soms 1½ Twists | - | - | - | 3.2 | - | - | - | 3.1 | - | - | - | 3.3 |
| 624 5 | Armstand Back 2 Soms 2½ Twists | - | - | - | 3.6 | - | - | - | 3.5 | - | - | - | 3.7 |
| 624 7 | Armstand Back 2 Soms 3½ Twists | - | - | - | 4.0 | - | - | - | | - | - | - | |
| 626 1 | Armstand Back 3 Soms. ½ Twist | - | 3.4 | 3.2 | - | - | 3.2 | 3.0 | - | - | 3.6 | 3. 4 | - |
| 626 3 | Armstand Back 3 Soms 1½ Twists | - | 4.2 | 4.0 | - | - | | | - | - | | | - |
| 626 5 | Armstand Back 3 Soms 2½ Twists | - | 4.6 | 4.4 | - | - | | | - | - | | | - |

PART FIVE: HIGH DIVING RULES

1. GENERAL

1.1 These Rules shall govern all World Aquatics High Diving competitions including World Aquatics Championships and High Diving World Cups.

1.2 All high diving installations shall be in accordance with the World Aquatics Facilities Rules, inspected and approved by the delegate of World Aquatics, and a member of the Technical High Diving Commission no later than 120 days prior to the start of the competitions. Construction of new installations should be subject to an inspection of the proposed site and environmental conditions prior to commencement.

1.3 Divers younger than 18 years on December 31st in the year of the competition shall not be permitted to compete at the World Aquatics Championships or World Cups.

1.4 Diving Number Designations

1.4.1 All dives shall be designated by a system of 3, 4 or 5 numerals followed by a single letter.

1.4.2 The dives are divided into five (5) groups. The first digit (or the first two digits) shall indicate the group to which the dive belongs:

| | | | |
|-------------------------------------|---|----|-----------------|
| Front and front twist: | 1 | or | 51 |
| Back and back twist: | 2 | or | 52 |
| Reverse and reverse twist: | 3 | or | 53 |
| Inward and inward twist: | 4 | or | 54 |
| Armstand and armstand twist: | 6 | or | 6.1 – 6.2 – 6.3 |

1.4.3 In the Front, Back, Reverse and Inward group with three (3) numerals, a one (1) in the second digit indicates that the dive has a flying action during the dive. When there is no flying action the second digit shall be 0. The third digit shall indicate the number of half somersaults to be performed. For example: 2 = 1 somersault, 8 = 4 somersaults. When there are 5 or more somersaults there will be four digits with the third and fourth digit indicating the number of half

somersaults. For example 10 = 5 somersaults as 10(10) in a forward 5 somersaults.

1.4.4 In the Front, Back, Reverse and Inward group with four (4) numerals, a five (5) in the first digit indicates that the dive includes a twist. The second digit indicates the group or direction to which the dive belongs (for Example 5163 = front). The third digit indicates the number of half somersaults to be performed (for example 6 = 3 somersaults). The fourth digit indicates the number of half twists to be performed (for example 3 = 1 ½ twists). When there are five (5) or more twists, the last two digits indicates the number of ½ twists. For example, 524(10) in 2 somersaults back with five twists. In this case the number designation contains 5 numerals.

1.4.5 In the Armstand group with three digits (with the first digit 6) the second digit indicates the group or direction to which the dive belongs:

61 = Front

62 = Back

63 = Reverse

The third digit indicates the number of ½ somersault.

1.4.6 In the Armstand group with four digits, the fourth digit indicates the number of half twists to be performed. When there are 5 or more twists the last two digits indicate the number of ½ twists. For example, 625(10) in Armstand back 2 ½ somersaults with 5 twists. In this case the number designation contains 5 numerals.

1.4.7 The letter at the end of the dive number shall indicate the position in which the dive is performed:

A = Straight

B = Pike

C = Tuck

D = Free

E = 3 positions

1.4.8 “Free” position means any combination of one or more positions and is restricted in its use in some dive with twist.

1.4.9 3 positions means that during the dive all positions A, B and C must be shown. The straight position (A) must be shown as second position.

1.5 Degree of Difficulty

1.5.1 The degree of difficulty of each dive is calculated using the following formula (the component values of the formula are outlined in Rule 11.1:

$$A + B + C + D + E + F = \text{DEGREE OF DIFFICULTY (DD)}$$

1.5.2 As a guide, dives with their numbers and DD are tabled in Rule 11.2 .

1.5.3 Any dive which is not tabled in Rule 11.2 , but is used in a competition, shall be given the dive number and DD as determined in accordance with Rules 1.4 and 1.5.

1.5.4 In calculating the degree of difficulty for dives with twists, the following needs to be noted:

| Somersaults | Standing twisting dives | | | |
|--------------------|--------------------------------|------------------|------------------|--------------------|
| 1 or 2 | D | | | |
| 3 | Forward and Inward | | Back and Reverse | |
| | ½ - 2 ½ twist | 3 or more twists | ½ - 3 twist | 3 ½ or more twists |
| | B or C | D | B or C | D |
| 4 or more | B or C | | | |

| Somersaults | Armstand twisting dives | | | |
|--------------------|--------------------------------|------------------|--------------|--------------------|
| 1 ½ | D | | | |
| 2 ½ | Forward | | Back | |
| | ½ - 1 ½ twists | 2 or more twists | ½ - 2 twists | 2 ½ or more twists |

| | | | | |
|-------|--------|---|--------|---|
| | B or C | D | B or C | D |
| 3 1/2 | B or C | | | |

1.5.5 The *Appendices 6 and 7* are established by the World Aquatics Technical High Diving Committee (THDC) and approved by the World Aquatics Bureau.

2. COMPETITIONS

2.1 General

2.1.1 All entered high divers must submit evidence of safely executed dives for approval by the World Aquatics THDC in order to compete.

2.1.2 The order of diving shall be determined by a random draw. This shall be held at a technical meeting immediately after the final training session and prior to the first day of competition. When available an electronic draw shall be used.

2.1.3 At the World Aquatics Championships and other World Aquatics events there shall be a direct final competition. The last round of dives shall be performed in the reverse order of the ranking at the end of the previous round. In the case of a tie, the dive order shall be determined by a draw between the affected divers.

2.1.4 To determine the result, the scores of the dives of a diver are added. When two or more divers score the same number of points, a tie shall be declared for that particular place.

2.1.5 In all events, the diver with the highest total points shall be declared the winner of that event. Their final points shall rank the remaining divers.

2.1.6 The procedure for protests is outlined in I.13

2.2 Women 20m Platform

The height of the Women's competition shall be 20 metres. In special surroundings (i.e. natural), the height

tolerance can be +/- 1 meter.

2.2 Men 27m Platform

2.2.1 The height of the Men's competition shall be 27 metres. In special surroundings (i.e. natural), the height tolerance can be +/- 1 meter.

3. HIGH DIVING COMPETITION FORMAT

3.1 The men's and women's competition is divided into two (2) sessions in a two (2) or three (3) day program as agreed between World Aquatics and the OC.

3.2 The competitions for men and women shall comprise four (4) dives. A dive of the same number shall be regarded as the same dive.

3.3 Women 20m Platform

3.4 The Women's competitions shall comprise four (4) dives. One (1) required dive with a maximum Degree of Difficulty (DD) of 2.6 and one (1) intermediate dive with a maximum DD of 3.4 from two (2) different groups, and two (2) optional dives without limit of DD from two (2) different groups.

3.4.1 If the DD of the required dive is less than 2.6 or of the intermediate dive less than 3.4, the calculated DD following Rules 1.4, 1.5 and 11.1 will be used. If a diver performs a dive above 2.6 respectively 3.4 they will only receive 2.6 respectively 3.4.

3.5 Men 27m Platform

3.5.1 The Men's competitions shall comprise four (4) dives. One (1) required dives with a maximum DD of 2.8 and one (1) intermediate dive with a maximum DD of 3.6 from two (2) different groups, and two (2) optional dives without limit of DD from two (2) different groups.

3.5.2 If the DD of a required dive is less than 2.8 or of the intermediate dive less than 3.6, the calculated DD following Rules 1.4, 1.5 and 11.1 will be used. If a diver performs a dive above 2.8 respectively 3.6 they will only receive 2.8 respectively 3.6.

4. STATEMENT OF DIVES

4.1 Each diver shall deliver to the Referee, a complete statement of the selected dives on the official form of the event for the competition. A diver may provide two (2) reserve dives which may be substituted five (5) minutes before commencement of the final round of dives subject to the dive being compliant with the competition rules.

4.2 The diver is responsible for the accuracy of the statement in the list and the diver shall sign the statement of dives.

4.3 The statement of dives shall be submitted 24 hours before commencement of the competition.

4.4 The Referee may accept changes up to one hour after the end of the final published training session for each event. Changes may be made up to three (3) hours prior to the commencement of the competition, provided a fee accompanies it equivalent of 250 Swiss Francs.

4.5 Unless the statement is presented within the time prescribed, a diver shall not be admitted to the competition.

4.6 When the closing times have passed, no change in the statement of dives shall be permitted.

4.7 The statement of dives shall contain the following information in the order of execution of the dives:

- The number of each dive according to Rules 1.4.1 to 1.4.6.
- The execution or position of the dive according to Rule 1.4.7.
- The degree of difficulty as determined by the Formula described in Rule 1.5.

4.8 The dives in each round shall be executed by all the divers consecutively, according to the starting order.

4.9 The statement of dives shall take precedence over the scoreboard and any announcement.

5. COMPETITION PROCEDURE

5.1 Control of Competition

5.1.1 Every competition shall be controlled by a Referee, supported by Assistant Referees, together with Judges and a Secretariat.

5.1.2 The number of the dive to be performed and the position of execution shall be displayed on an indicator board visible to both divers and judges.

5.1.3 A computer programme with adequate capability to produce a judging analysis shall be used.

5.1.4 When electronic scoring equipment is not available the judges must have flash cards to display their awards. These flash cards must be capable of showing awards from 0 to 10 by half points.

5.2 Composition of the Judges Panels

5.2.1 Whenever possible, seven (7) judges from different Federations shall be used.

5.2.2 If not enough judges are available, five (5) judges from different Federations may be used.

5.2.3 The Referee shall place the judges on one side of the platform (detailed specifications see V.11.1.5).

5.2.4 Once placed, a judge shall not change position unless at the discretion of the Referee, and then only in exceptional circumstances.

5.2.5 When a judge is unable to continue to function after the competition has started, this judge shall be replaced by the reserve judge, preferably at the end of a round.

5.2.6 After each dive, on a signal given by the Referee, each judge shall immediately and simultaneously, without communicating with one another, and in a distinct manner, indicate the award for the dive. When an electronic judging device is used, the

judges shall enter their awards into their electronic score pads immediately after the performance of the dive.

5.2.7 The judges' awards shall be displayed on the electronic scoreboard, preferably unseen by the judges. The awards (without any other information about the standing of the competition) must be seen by the judges on their electronic score pads.

6. DUTIES OF THE REFEREE AND ASSISTANT REFEREES

6.1 The Referee shall be in control of the competition and located in a position so that the Referee can manage the competition and ensure that the Rules are observed.

6.2 The Referee may designate Assistant Referees.

6.3 Duties of the Referee before the competition

6.3.1 The Referee shall inspect the statements of dives. If the statement does not comply with the Rules, the Referee shall have it corrected before the beginning of the competition but in accordance with the rules of the event.

6.3.2 The diver shall be informed of the Referee's decision, that a correction is required, as soon as possible.

6.4 Duties of the Referee during the competition

6.4.1 In the case of unforeseen circumstances, the Referee may declare a short break, a postponement or a discontinuation of the competition. If possible, the break should be done after a full round of dives.

6.4.2 Following an interruption, the competition shall be continued from where it was stopped. The points scored before the interruption shall be carried forward into the remaining portion of the competition, whenever it is held. The final results must be based on the last complete round of dives.

17 NOTE: If the competition cannot be continued, the result will be determined by the Jury of Appeal.

6.4.3 When there is a strong wind, the Referee may give a diver the right to make a re-start without deduction of points.

6.4.4 Before each dive, the Referee or the official announcer shall announce in the language of the host country the name of the diver and the dive to be executed. If a scoreboard is used, all information concerning the dive shall be displayed and the announcement may be restricted to the identification of the diver.

6.4.5 When a dive is incorrectly announced, the diver or their representative shall advise the Referee immediately, who shall then confirm the diver's statement of dives.

6.4.6 If the incorrectly announced dive is executed by the diver, the Referee may cancel it and have the correct dive announced and performed immediately. The awards for the first dive must be noted should a protest be lodged.

6.4.7 The dive shall be executed after a signal given by the Referee. The signal shall be given as soon as the diver has checked the position of the safety swimmers and has informed the Referee that they is ready to perform the dive, and after the Referee has checked the indicator board.

6.4.8 Each diver shall be given sufficient time for the preparation and execution of the dive. If it takes more than one minute after the Referee has given a warning, the diver shall receive zero (0) points for the dive announced.

6.4.9 When a diver refuses to execute a dive, the Referee shall declare a failed dive.

6.4.10 If a diver in a competition disturbs a contest, the Referee may exclude this diver from that competition. If a member of a team, a coach or an official disturbs a contest; the Referee may exclude that person

from the competition area.

6.4.11 The Referee may remove any judge from the competition whose judgement the Referee regards as unsatisfactory and may appoint another judge to replace this judge. At the end of the competition the Referee shall make a written report to the Jury of Appeal.

6.4.12 Such a change of judge shall take place only at the end of a session or round of dives.

6.5 Duties of the Referee during the dive

6.5.1 When the Referee is certain that a diver has performed a dive of a number other than that announced, the Referee shall declare it a failed dive.

6.5.2 When it is quite clear that the dive has been performed in a position other than that announced, the Referee shall repeat the announcement, and declare that the maximum award shall be 2 points, before giving the judges the signal to show their marks. If a judge then awards more than 2 points, the Referee shall declare the award from that judge to be 2 points.

6.5.3 When a dive is performed with a break of position during the flight, the Referee shall declare the maximum award to be 4 ½.

6.5.4 When the Referee is certain that in a dive with a flying action, the straight position is not shown for at least (90°), the Referee shall declare a maximum award of 4 ½ points.

6.5.5 If during the execution of a dive, a diver is unsafely close to the platform or touches the end of the platform with their head, the Referee shall declare a maximum award of 2 points. Preferable the Referee's decision is based on a measurement of the distance by a camera.

6.5.6 When a twist is greater or less than 90° at the

entry, the Referee shall declare it a failed dive.

6.5.7 When one or both arms are held above the shoulder line at the entry, the Referee shall declare the maximum award to be 4½ points. If a judge then awards more than 4 ½ points, the Referee shall declare the award from that judge to be 4½ points.

6.5.8 During the execution of a dive, there shall be no assistance given to the diver from any person. Assistance between dives shall be permitted.

6.5.9 The Referee may declare a dive to be failed if they considers that assistance has been given to the diver after the starting signal.

6.5.10 When there is a restart in a running, standing or armstand dive, the Referee shall deduct 2 points from the award of each judge.

6.5.11 When a second attempt (a re-start) is unsuccessful the Referee shall deduct 4 points from the award of each judge.

6.5.12 When a third attempt is unsuccessful, the Referee shall declare a failed dive.

6.6 Duties of the Referee after the competition

6.6.1 At the end of the competition the Referee shall confirm the final results by the signature.

6.7 Duties of the Assistant Referees

6.7.1 The Assistant Referee, positioned on the platform, shall:

- observe if the armstand is executed as prescribed,
- observe the air speed indicator,
- fulfil any other task delegated from the Referee to the Assistant Referee.

6.7.2 The Assistant Referee, positioned on the platform, shall report to the Referee:

- a re-start or failed dive in an armstand dive,

- when the average wind speed exceeds 40 km per hour.

7. DUTIES OF THE SECRETARIAT

7.1 The records of the competitions shall be kept by two independent secretaries.

7.2 In order to facilitate the scoring, a computer, a rapid calculator, or a chart may be used.

7.3 The judges' awards shall be announced in their seating order and the first secretary shall record all awards as announced on the diver's statement of dives. When a computer and a scoreboard are used, the announcement of the judges' awards is not necessary and the secretary may record the awards directly from the monitor.

7.4 The second secretary shall enter the judges' awards on the diver's statement of dives. When a computer is used to determine the scores, the second secretary may record the awards directly from the monitor.

7.5 When seven (7) judges are used the secretaries shall cancel the two (2) highest and the two (2) lowest judges' awards. When more than two (2) awards are equal only two of the equal awards shall be cancelled. If only five (5) judges are used, the secretaries shall cancel the highest and the lowest award.

7.6 The secretaries shall independently add the remaining awards and multiply this total by the degree of difficulty for the dive to determine the score of the dive according to the following examples:

Five (5) judges: $8.0, 7.5, 7.5, 7.5, 7.0 = 22.5 \times 3.8 = 85.5$

Seven (7) judges: $8.0, 7.5, 7.5, 7.5, 7.5, 7.5, 7.0 = 22.5 \times 3.8 = 85.5$

7.7 When a judge by reason of illness or any other unforeseen circumstances, has made no award for a particular dive, the average of the awards of the other judges shall be adopted as the missing award. The award shall be rounded up or down to the nearest half point or

whole point. Averages ending in .01 to .24 shall be lost. Averages ending in .25 to .74 shall be rounded to .50. Averages ending in .75 or higher shall be rounded up to the next whole point.

7.8 At the end of the competition the two secretaries shall compare the score sheets.

7.9 The result of the competition shall be obtained from the score sheets.

7.10 If electronic officiating equipment is in use, it is allowable to use only one secretariat. The secretariat records the awards and the electronic result only, to make sure that the final result can be calculated in a case that the electronic officiating equipment breaks down.

7.11 The final result shall be announced in one of the official languages of World Aquatics (English or French).

8. JUDGING

8.1 General

8.1.1 A judge, seated at the side of the platform, shall award from 0 to 10 points for a dive according to their overall impression within the following criteria:

| | |
|--------------------------|-----------|
| Excellent | 10 |
| Very Good | 8.5 – 9.5 |
| Good | 7.0 – 8.0 |
| Satisfactory | 5.0 – 6.5 |
| Deficient | 2.5 – 4.5 |
| Unsatisfactory | 0.5 – 2.0 |
| Completely failed | 0 |

8.1.2 When judging a dive, the judge must not be influenced by any factor other than the technique and execution of the dive. The dive must be considered without regard to the approach to the starting position, the difficulty of the dive, or any movement beneath the

surface of the water.

8.1.3 The points to be considered in judging the overall impression of a dive are the technique and grace of:

- the starting position and the take-off
- the flight
- the entry

8.2 Starting position

8.2.1 The starting position in standing dives shall be assumed when the diver stands at the front edge of the platform, in a running dive when the diver is ready to take the first step of the run and in an armstand dive when both hands are on the front end of the platform and both feet are off the platform.

8.2.2 When, in an armstand dive, a stationary and steady balance in the straight vertical position is not shown, each judge shall deduct from $\frac{1}{2}$ to 2 points, according to their opinion.

8.2.3 A re-start shall be allowed when a diver:

- in a standing or running dive stops and then continues,
- in an armstand dive loses the balance, one or both feet return to the platform, or any other part of the body other than the hands touches the platform,
- in an armstand dive loses the balance and moves one or both hands from the original position at the front end of the platform.
- This shall be deemed a re-start and the Referee shall declare a 2 point deduction from each judge and a 4 point deduction after the second re- start.

8.3 The take-off

8.3.1 The take-off in forward dives may be performed either standing or running at the option of the diver. The take-off in backward, reverse and inward dives must be performed standing.

8.3.2 The take-off shall be balanced, powerful and with an appropriate distance to the platform.

8.3.3 When the take-off is not balanced, powerful and with an appropriate distance to the platform, the judges shall deduct from ½ to 2 points according to their opinion.

8.3.4 In dives with twist, the twisting shall not be manifestly done from the platform. If the twisting is manifestly done from the platform, the judges shall deduct ½ to 2 points, according to their opinion.

8.4 The flight

The dive can be executed in the following positions:

8.4.1 Straight (A)

8.4.1.1 In the straight position, the body shall not be bent either at the knees or hips. The feet shall be together and the toes pointed. The position of the arms is at the option of the diver.

8.4.1.2 If the straight position is not shown as prescribed, the judges shall deduct from ½ to 2 points, according to their opinion.

8.4.2 Pike (B)

8.4.2.1 In the pike position, the body shall be bent at the hips, but the legs must be kept straight at the knees, the feet shall be together, and the toes pointed. The position of the arms is at the option of the diver.



18 These diving illustrations serve as a guide only and the position of the arms is at the choice of the diver except in the entry.

8.4.2.2 If the pike position is not shown as prescribed, the judges shall deduct from ½ to 2 points, according to their opinion.

8.4.3 Tuck (C)

8.4.3.1 In the tuck position, the body shall be compact, bent at the knees and hips with the knees and feet together. The hands shall be on the lower legs and the toes pointed.



19 These diving illustrations serve as a guide only and the position of the arms is at the choice of the diver except in the case of the hands in the tuck and the entry.

8.4.3.2 If the tuck position is not shown as prescribed, the judge shall deduct from ½ to 2 points, according to their opinion.

8.4.4 Free position (D)

8.4.4.1 In the free position, the body position is optional but the legs shall be together and the toes pointed.

8.4.4.2 In somersault dives with twist, the twist may be performed at any time during the flight.

8.4.4.3 If the free position is not shown as prescribed, the judges shall deduct from ½ to 2 points, according to their opinion.

8.4.5 Three (3) positions (E)

8.4.5.1 During the dive all three positions (A, B and C) must be shown. The straight position (A) must be shown as second position.

8.4.5.2 If the 3 positions are not shown as prescribed, each judge shall deduct from ½ to 2 points, according to their opinion.

8.4.6 Flying (F)

8.4.6.1 In all flying dives a straight position shall be clearly shown and that position shall be assumed from the take-off. When the straight position is not shown for at least one quarter of a somersault (90°) the maximum award by the judges shall be 4½ points, notwithstanding that the Referee has not declared maximum 4 ½ points.

8.4.6.2 When a diver touches the platform during the flight

with the feet or hands, the judges shall deduct according to their opinion.

8.4.6.3 When a diver is unsafely close to the platform or touches the end of the platform during the flight with the head, the judges shall award up to 2 points, notwithstanding that the Referee has not declared a maximum award of 2 points. If the majority of the judges (at least three (3) in a 5 judge panel / at least four (4) in a 7 judge panel) award two (2) or less points, all higher scores shall be two (2) points.

8.4.6.4 When a judge considers that a dive of a different number has been performed the judge may award zero (0) points, notwithstanding that the Referee has not declared it to be a failed dive.

8.4.6.5 When a dive is performed clearly in a position other than that announced the dive shall be deemed unsatisfactory. The highest award for such a dive is 2 points, notwithstanding that the Referee has not repeated the announcement and declared maximum 2 points.

8.4.6.6 When a dive is performed with a break of position during the flight, the highest award for such a dive is 4 ½ points, notwithstanding that the Referee has not declared maximum 4 ½ points.

8.4.6.7 When a dive has a break in the position just at or before the entry, the judges shall deduct from ½ to 3 points, according to their discretion.

8.5 The entry

8.5.1 The entry into the water shall in all cases be vertical, not twisted, with the body straight and the feet together.

8.5.2 When the entry is short or over or twisted the judges shall deduct according to their opinion

8.5.3 At the entry the arms shall be at the body

below the navel. If one or both arms are held above the shoulder line on entry, the highest award for such an entry is 4½ points, notwithstanding that the Referee has not declared maximum 4½ points.

8.5.4 Other than as provided in Rule V.8.5.3, when the arms are not in the correct position, the judges shall deduct from ½ to 2 points, according to their opinion.

8.5.5 When a twist is greater or less than that announced by 90 degrees or more, the judges shall award zero (0) points, notwithstanding that the Referee has not declared it to be a failed dive.

8.5.6 The dive is considered to have been completed, when the whole of the body is completely under the surface of the water.

9. SUMMARY OF THE PENALTIES

9.1 Referee to declare "Failed Dive"; 0 points

V.6.4.8 If a diver use more than one minute after the Referee has given warning.

V.6.4.9 If a diver refuses to execute a dive.

V.6.5.1 If a diver has performed a dive of a number other than that announced.

V.6.5.6 If a twist is more or less than 90° at the entry than that announced.

V.6.5.9 If assistance has been given to the diver after the starting signal.

V.6.5.12 When a third attempt (a re-start) is unsuccessful.

9.2 Referee to declare "2 points deduction"

V.6.5.10 (also V.8.2.3) If there is a re-start in a standing, running, or armstand dive.

9.3 Referee to declare "4 points deduction"

V6.5.11 If there is a second re-start in a standing, running, or armstand dive.

9.4 Referee to declare "2 points maximum"

V.6.5.2 If a diver performs a dive in a position other than that

announced.

V.6.5.5 If a diver is unsafely close to the platform or touches the platform with the head.

9.5 Referee to declare "4 ½ points maximum"

V.6.5.3 If a dive is performed with a break of position during the flight.

V.6.5.4 If the straight position in a dive with flying action is not shown for at least 90°.

V.6.5.7 If a diver held one or both arms above the shoulder at the entry.

9.6 Judges to award "0 points"

V.8.4.6.4 If a dive of a different number was executed.

V.8.5.5 If a twist is greater or less than that announced by 90° or more.

9.7 Judges to award "2 points maximum"

V.8.4.6.3 If a diver is unsafely close to the platform or touches the platform with the head.

V.8.4.6.5 If a dive is performed clearly in a position other than that announced.

9.8 Judges to award "4 ½ points maximum"

V.8.4.6.1 If in a flying dive, a straight position is not clearly shown for at least one quarter of a somersault (90°).

V.8.4.6.6 If a dive is performed with a break of position during the flight.

V.8.5.3 If the arms are above the shoulder line at the entry.

9.9 Judges to deduct "from ½ to 2 points"

V.8.2.2 If in an armstand dive, a stationary and steady balance in the straight vertical position is not shown.

V.8.3.3 If the take-off is not balanced, powerful and with an appropriate distance to the platform.

V.8.3.4 If in a twist, the twisting is manifestly done from the platform.

V.8.4.1.2 If the straight position is not shown as prescribed.

V.8.4.2.2 If the pike position is not shown as prescribed.

V8.4.3.2 If the tuck position is not shown as prescribed.

V.8.4.4.3 If the free position is not shown as prescribed.

V.8.4.5.2 If the 3 positions are not shown as prescribed.

V.8.5.4 If the arms are not in the correct position at the entry.

9.10 Judges to deduct "from ½ to 3 points"

V.8.4.6.7 If there is a break in the position at, or just before, the entry.

9.11 Judges to deduct "according to individual opinion"

V.8.4.6.2 If a diver touches the platform during the flight with the feet or hands.

V.8.5.2 If the entry is short or over or twisted.

10. AGE GROUP RULES

10.1 World Aquatics Rules of competition will apply in all age group competitions.

10.2 Age Categories

All age group high divers remain qualified from the 1st of January to midnight of the following 31st of December in the year of competition.

10.3 High Diving Events

10.3.1 Group A

10.3.1.1 Age: 17 or 18 years on December 31st of the year of the competition.

20 Note: The divers at the age of 18 years would not be restricted from diving in the senior events if they are competent to do so.

10.3.1.2 Competition Format

10.3.1.2.1 Girls' and Boy's Platform 15 meter

This competition shall comprise four (4) different standing dives from at least three (3) groups.

Two (2) dives with an assigned degree of difficulty of 2.5 and two (2) dives without limit of degree of difficulty.

At least one (1) dive must have a Barani and at least one (1) dive must have an unnatural entry (back or reverse rotating entries).

10.3.2 Group B

10.3.2.1 Age: 15 or 16 years on December 31st of the year of the competition.

10.3.2.2 Competition Format

10.3.2.2.1 Girls' and Boy's Platform 12 meter

This competition shall comprise four (4) different standing dives from at least two (2) groups.

Two (2) dives with an assigned degree of difficulty of 2.4 and two (2) dives without limit of degree of difficulty.

At least one (1) dive must have a Barani and at least one (1) dive must have an unnatural entry (back or reverse rotating entries).

10.4 General Rules for World Aquatics Junior High Diving Championships

10.4.1 World Aquatics Junior High Diving Championships shall be conducted every two years in Groups A and B.

10.4.2 Each Federation is entitled to enter a maximum of three (3) divers in each event.

10.4.3 The divers shall only compete in their age group.

10.4.4 The divers shall perform a full list of dives as indicated in their age group.

10.4.5 Each event shall be a direct final competition, irrespective of the number of entrants.

10.4.6 In the fourth and final round, the divers will start in the reverse order of their ranking after the third round.

10.4.7 The program schedule shall be agreed by the Bureau upon recommendation of the Technical High Diving Committee.

10.4.8 Preferably seven (7) judges shall officiate.

10.4.9 The Championships shall be conducted in the period of two (2) days or three (3) days.

12 HIGH DIVING FACILITIES AND EQUIPMENT

12.1 High Diving Facilities

12.1.1 General requirements and definitions

World Aquatics High Diving is preferably performed in controlled environments with customised from fabricated diving towers in conjunction with fabricated pools. Rectangular dimensions are the preferred option for permanent artificial pools. Temporary round pools can be used in special circumstances.

High Diving can also be performed from fabricated platforms on existing buildings or natural cliff faces into open water (sea, lakes or rivers etc). Special permission and guidance is required from World Aquatics under these circumstances.

Dimensions in metres for all high diving facilities as detailed in the Appendix 2 and Appendix 3, shall be observed. The Diagrams in Appendices 1, 2, 3, 4 and 5, , , are established by the World Aquatics experts in cooperation with the World Aquatics Technical High Diving Committee and approved by the World Aquatics Bureau.

In special surroundings the dimensions and requirements can be adjusted to the local situation upon recommendation by the World Aquatics facilities experts and the World Aquatics THDC and approved by the World Aquatics Bureau.

Security: The dimensions of these facilities are only for the use of expert athletes and they are not suitable for public use. It is required by the local organising committees and local authorities to provide security guards and / or lockable structures or gates to prevent any unauthorised persons to climb the diving towers.

12.1.2 Platform High Diving

12.1.2.1 Each platform shall be rigid and horizontal.

12.1.2.2 The dimensions of the platform shall be:

| Platform | Width | Length | * |
|--------------------|-------------------|------------------|---|
| 3 m | 2.00 m (1.50 m *) | 5.00 m (2.0 m *) | |
| 5 m | 2.00 m (1.50 m *) | 5.00 m (2.0 m *) | |
| 7.5 m | 2.00 m (1.50 m *) | 5.00 m (2.0 m *) | |
| 10 m | 2.00 m (1.50 m *) | 5.00 m (2.0 m *) | |
| 15 m (11 m – 19 m) | 2.00 m (1.50 m *) | 5.00 m (2.0 m *) | |
| 20 m | 2.00 m | 5.00 m | |
| 21 m – 26 m | 2.00 m (1.50 m *) | 5.00 m (2.0 m *) | |
| 27 m | 2.00 m | 5.00 m | |

Accepted for events other than World Aquatics Championships and High Diving World Cups

12.1.2.3 The thickness of the front edge of the platform shall not exceed 0.20 metre and can be vertical or inclined at an angle not greater than 10° to the vertical inside the plummet line.

12.1.2.4 The entire surface of all platforms shall be covered with slip- resistant material that shall have a tread pattern that provides sufficient traction in wet and dry conditions such that the divers are prevented from slipping when performing dives in all directions.

12.1.2.4.1 If an unknown surface material is proposed, a physical sample must be sent to the World Aquatics THDC for testing and approval before it can be used.

12.1.2.4.2 Terracotta is the preferred colour of the platform surface material. Black, white and blue coloured surface material is not permitted.

12.1.2.4.3 The colour of the carpet on the pool deck must not be blue. Grey is the preferred option.

12.1.2.5 The back and sides of each platform shall be surrounded by handrails up to 1m from the edge of the platform with a minimum clearance of 1.8 metres between vertical pairs. The minimum height shall be 1.0 metre and they shall be with at least two horizontal crossbars placed outside the

platform beginning 1.00 metre from the front edge of the platform.

12.1.2.6 Each platform shall be accessible by suitable slip-resistant stairs (not ladders) as required by the country's building regulations and or health and safety standards that are applicable.

12.1.2.7 It is preferable that a platform is not constructed directly under any other platform however in circumstances where this cannot be avoided then the dimensions in V.11.5.2 (Appendix 2) must be observed.

12.1.2.8 The platform shall be a concrete, steel or other rigid material construction as approved by World Aquatics. The longitude and latitude movement/oscillation allowance for the entire 27 metres high tower structure shall be 2.7 cm (1/1000 from 27m). The maximum wind speed for the tower oscillation stability is 54km/hour (banners will affect the stability). The downward flex at the diving end of the platform shall not exceed 2-3mm and approved by the local authority of the area.

12.1.3 General Requirements

12.1.3.1 For High Diving platforms designed and constructed after 31st December 2017 the minimum dimensions in metres for high diving facilities as detailed on the tables V.11.5.2 (Appendix 2) and V.11.5.4 (Appendix 4) shall prevail, using, as a basic measuring point of reference, the plummet line, which is a vertical line extending through the centre of the front edge of the platforms.

12.1.3.2 The platforms shall face north in the northern hemisphere and south in the southern hemisphere where possible.

12.1.3.3 The water temperature should be not less than 18°C in open water venues and preferable not less than 26°C degrees in venues with an artificial pool.

12.1.3.4 A certificate of suitability for use of the venue shall be issued by the appropriate local health and safety authorities. In general terms the certification must also relate to the general water quality for human use.

12.1.3.5 The surface agitation shall be done by a strong horizontal water spray and the scuba divers must also provide additional splash when necessary. The water spray must not be mounted higher than 1.50m above the water level. The water spray should be strong and provide foamy white water for better visibility for the athletes. The spray or the foam must be strong enough to cover the landing area.

12.1.3.6 If the wind speed exceeds 40kph (kph= kilometre per hour) then the Referee shall decide if the competition can continue or must be interrupted until the wind speed is below 40kph. A transportable air speed indicator must be available for use on the 20m and 27m platforms.

If lightning strikes are within 3km of the dive site then the training or the competition must be suspended until the storm distance is greater than 3km.

12.1.4 Security and Emergency Rescue Requirements

12.1.4.1 To take into consideration the different facilities in High Diving (natural surroundings with open water, temporary or permanent facilities with artificial pools and clear water and line of site of the pool), the security and emergency rescue requirements may vary.

12.1.4.2 the requirements for different High Diving facilities are described in the following table.

| | Facilities with open water | | Temporary Facilities with artificial pool ⁸⁾ | | Permanent Facilities | |
|-----------------------------------|----------------------------|-------------|---|-----------------|----------------------|----------------------|
| | Training | Competition | Training | Competition | Training | Competition |
| Medical staff | | | | | | |
| Doctors ¹⁾ | 1 to 2 | 2 | 1 to 2 | 2 | | 1 to 2 |
| Staffed ambulance | 1 | 2 | 1 | 2 | ²⁾ | 1 to 2 |
| Designated hospital ³⁾ | 1 | 1 | 1 | 1 | 1 | 1 |
| Safety Team | | | | | | |
| Safety captain | 1 | 1 | 1 | 1 | 4) | 1 ⁵⁾ |
| Scuba diver | 1 | 1 | 1 ⁶⁾ | 1 ⁶⁾ | | 1 ⁶⁾ |
| Apnea swimmer | 3 | 3 | 2 | 2 | | 2 ⁵⁾ |
| Reserve apnea sw. | 2 to 3 | 2 to 3 | 1 to 2 | 2 | | 1 to 2 ⁵⁾ |
| Rescue equipment | | | | | | |
| Rescue boats | 2 | 2 | | | | |
| Spinal boards | 2 | 2 | 2 | 2 | 2 | 2 |
| Stiff neck collars | 5 | 5 | 5 | 5 | 5 | 5 |
| Defibrillators | 2 | 2 | 2 | 2 | 2 | 2 |
| Oxygen tanks | 2 | 2 | 2 | 2 | 2 | 2 |
| Blankets | 4 to 5 | 4 to 5 | 4 to 5 | 4 to 5 | 4 to 5 | 4 to 5 |
| General first aid kit | 1 | 1 | 1 | 1 | 1 | 1 |
| For recovery | | | | | | |
| Ice baths ⁷⁾ | 2 | 2 | 2 | 2 | 2 | 2 |

¹⁾ Doctors with knowledge in trauma injuries.

²⁾ Staffed ambulance on alert within 15 minutes

³⁾ Hospital on alert with orthopedic surgery.

⁴⁾ For all High Diving training sessions from heights ranging from 10m up to 27m in permanent High Dive facilities with a constructed pool with clear water and line of site to the bottom of the pool it is recommended that at least two lifeguards should be dedicated to the High Diving pool and a third lifeguard on duty that can be called in to assist via radio, verbal call or via hand signals. The two lifeguards at the High Dive Pool should be stationed as close the pool edge as possible to minimize the response time in case of emergency. It is recommended that pool management conduct regular deep water rescue rehearsals.

⁵⁾ Facilities may implement qualified local staffing to cover part of, or all of these water safety requirements.

⁶⁾ In Facilities that are Temporary with an artificial pool or Permanent, the scuba safety diver is not required, unless specified by the water safety captain.

⁷⁾ minimum width 0.8 m, length 1.2 m, depth 1 m or 14 ° C water tubs.

⁸⁾ Upon the occasion of a Temporary Platform constructed in a Permanent facility, the Safety Requirements outlined under Permanent Facilities would apply.

12.1.4.3 Location of the FoP First Aid Treatment Area

The Medical Station and/or the Field of Play (FoP) Treatment Area are to be designated at each competitive venue. Due to the outdoor nature of the sport, it may happen that the Medical Station will not be nearby the competition venue. Therefore, the FoP Treatment Area should be organized

based on the specificity of each site. For instance, it could be a Medical Boat in sea/ocean environment or on a temporary platform where the divers exit the water.

In indoor and controlled environment, the Medical Station and/or the FoP Treatment Area are easier to set up and the Area should be clearly labelled and be within easy access from the Field of Play.

Access to ambulance transport (whatever it may be: road, boat, helicopter) should also be easily reached from the treatment area.

12.1.4.4 Water Safety Team, Standard Procedure for each dive

12.1.4.4.1 General instructions

Instructions for the members of the water safety team (in the water):

- Determine the proper alignment around the point of entry of the High Divers. Return as quickly as possible to your position after any “action”.
- Find reference points to make sure you are in the right spot.
- Be aware of any currents that can pull you out of position.
- Always look up to the platform to know when the divers are planning to dive.
- The High Divers will sometimes indicate to the water safety team members to move closer or further away from the point of entry with hand signals.
- The members of the water safety team must try to see the whole dive of the High Diver. As soon as the High Diver hits the water, the members of the water safety team dive down to approximately 3 meters in the direction of the High Diver and estimate the condition of the High Diver. Thereafter they come up to the surface with the High Diver.
- Once the High Diver gives the OK sign on the surface of the water, the water safety members return to their position quickly and look back up at the platform.

12.1.4.4.2 Hazardous Entry or Landing

If the referee calls out on the emergency channel on the radio, 'BAD LANDING':

- The water safety captain in the boat or on the pool deck must signal the water safety team with a loud whistle or with a hand signal to immediately secure the High Diver on a spinal board with a stiff neck collar. If the High Diver is unable to breathe, turn him/her on his/her back and keep the nose and mouth well out of the water. The High Diver must be secured on a spinal board while still in the water and only thereafter transferred onto land (deep water spinal injury management). Then proceed to the doctor's area or ambulance immediately.
- The doctor will make the call about further treatment. This could be treatment in the competition area (and no hospitalization), or transportation to a hospital. It is highly unlikely that the doctor will allow the diver to continue competition after a bad landing.

It's important that a designated World Aquatics representative could travel with the High Diver to hospital.

Note: even without a bad landing a diver may sustain a serious injury or even be knocked unconscious.

It is important that High Divers are allowed to consult with medical professionals on site during the competition whether it is medically responsible to continue with the competition. High Divers can inform the referee at any time that they wish to withdraw from the competition.

12.1.4.4.3 Rescue Map

A clear evacuation path – which may vary at each event location – shall be clearly known by the rescue team.

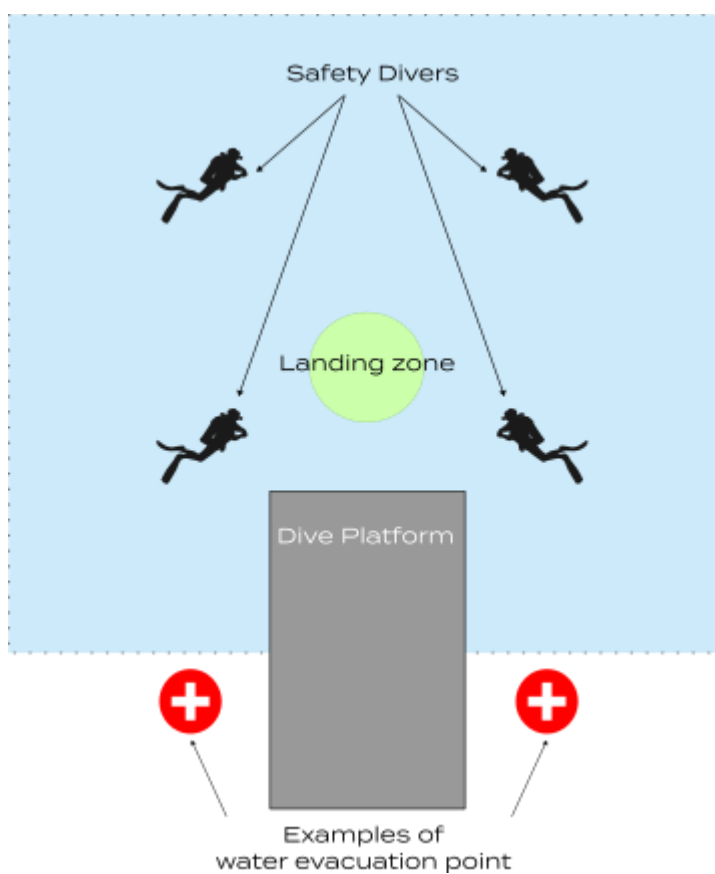

12.1.5 Judges Seating

12.1.5.1 The judges shall be placed side by side in two lines on one side of the platform with the sunlight in the back or above the judges. In indoor facilities and special circumstances, the Referee may decide that the judges are placed on both sides of the platforms.

12.1.5.2 No judge shall be seated behind the front edge of the platform.

12.1.5.3 The judges shall be seated at a distance of not less than 30 meters and not more than 40 meters from the entry point of the platforms, and in a position elevated between three (3) and six (6) metres above the water level. Special local circumstances may influence the position of the judges.

12.2 High Diving Facilities for World Aquatics Championships

Rules 12.1 to 12.1.5.3 apply to the World Aquatics Championships.

12.3 Automatic Officiating Equipment for High Diving

12.3.1 Electronic Officiating equipment records the judges awards for each diver and determines the final score for each dive as required by Rule 7.

12.3.2 Preferred Equipment must be able to:

12.3.2.1 Record judges awards by whole and half points

12.3.2.2 Be able to display all recorded and calculated information for each diver both before and after each dive

12.3.2.3 Be able to display the scores for all divers before and after each dive

12.3.2.4 Be able to display the rank order and scores for all divers after each round of dives

12.3.2.5 The equipment must provide each judge with an electronic judging device that will permit each judge to enter their award and to see their award on a window on the device. After the referee has accepted the judges awards, all awards shall be displayed on each electronic judging device

12.3.2.6 Judges analysis is to be provided at the conclusion of each event or series

12.3.2.7 The referee must be provided with a monitor on which he/she will be able to view the awards of all the judges prior to the awards then being displayed on the score board, and preferable with a video camera, to observe the divers performance if needed.

12.3.2.8 There is a requirement for a print out of the following information:

- 1) The draw for the diving order
- 2) A start list for each session or event
- 3) A ranking of dives at the end of each round
- 4) A ranking of dives at the end of each event
- 5) Judges awards and scores for each diver at the end of each session and event

12.4 Dry Land Facilities

12.4.1 For the safety, practice and development of high divers and competitions, it is strongly recommended that the guidelines presented below be incorporated into the facility and placed adjacent to the competitive high diving area / facilities.

12.4.2 Recommended equipment in dry land area

- 1 x Trampoline, Olympic standard,

length 5.2 m, width 3.05 m, height 1.15 m

- 4 x Foam Crash Mats,

minimum length 1.4 m, width 1.0 m, height 0.25 m

- 2 x Somersault Boxes,

minimum length 1.0 m, width 1.0 m, height 0.3 m

- 25 x Exercise mats,

length 1.8 m, width 0.5 m, height 0.02 m

- 5 x Spinning Bikes

12.5 Appendices

APPENDIX 1 - Diagram / General Standard Facilities

APPENDIX 2 – Table / General Standard Facilities Dimensions

APPENDIX 3 - Diagram / Temporary Round Pools

APPENDIX 4 - Table / Temporary Round Pools / Dimensions

APPENDIX 5 – Diagram / General Standard Facilities combined with Diving

APPENDIX 6 – Diagram 12m Box

Appendix 1 - Diagram / General Standard Facilities

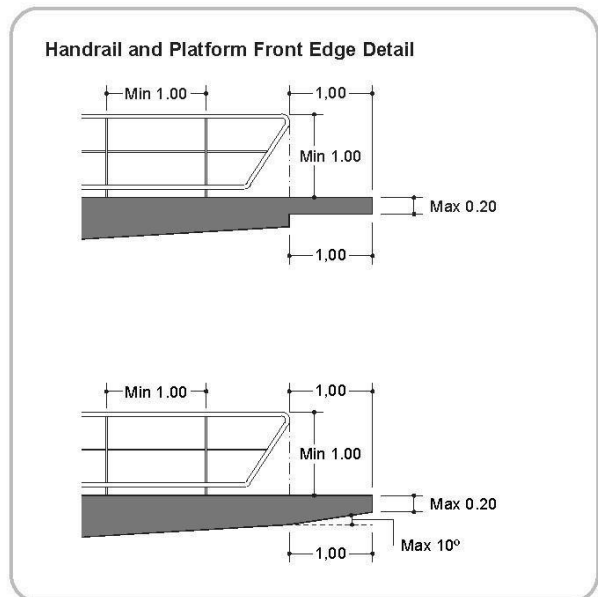
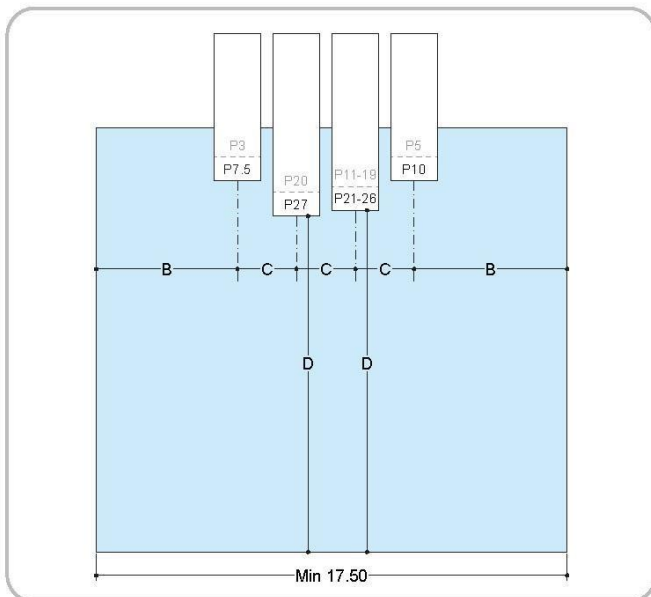
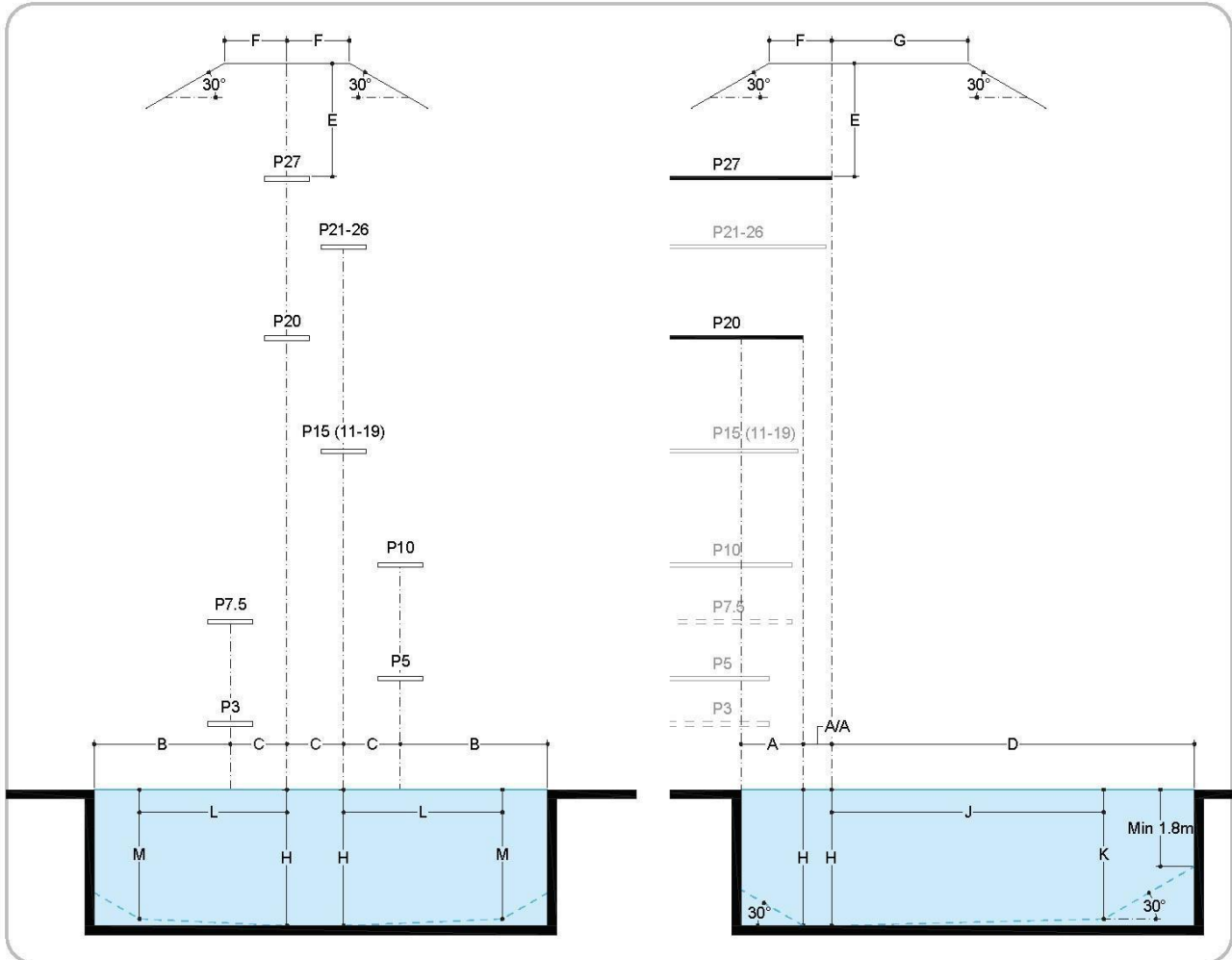

Appendix 2– Table / General Standard Facilities Dimensions

| World Aquatics | | | PLATFORM | | | | | | | | | | | | | | | |
|---------------------------------------|--|-------------------------|-------------|-------------|---------------|-------------|-----------------|---------------|----------------|--------------|------------------------------|--------------|----------------|--------------|---------------------|-------------------|----------------|--------------|
| Dimensions for High Diving Facilities | | | P 3 | | P 5 | | P 7.5 | | P 10 | | P 15 (P 11-19) ¹⁾ | | P 20 | | P 21-26 | | P 27 | |
| | Length | Minimum ²⁾ | 5.00 | | 5.00 | | 5.00 | | 5.00 | | 5.00 | | 5.00 | | 5.00 | | 5.00 | |
| | Width | Minimum ³⁾ | 2.00 | | 2.00 | | 2.00 | | 2.00 | | 2.00 | | 2.00 | | 2.00 | | 2.00 | |
| | Height | | 3.00 | | 5.00 | | 7.50 | | 10.00 | | 15.00 | | 20.00 | | 21.00 - 26.00 | | 27.00 | |
| | | Tolerance ⁴⁾ | ± 0.05 | | ± 0.05 | | ± 0.05 | | ± 0.05 | | ± 0.05 | | ± 0.05 | | ± 0.05 | | ± 0.05 | |
| | | | Horiz | Vert | Horiz | Vert | Horiz | Vert | Horiz | Vert | Horiz | Vert | Horiz | Vert | Horiz | Vert | Horiz | Vert |
| A | From plumbet BACK TO POOL WALL or OBSTACLE | Designation | A-P3 | | A-P5 | | A-P7.5 | | A-P10 | | A-P15 | | A-P20 | | A-(P21-26) | | A-P27 | |
| | | Minimum | 1.25 | | 1.25 | | 1.25 | | 1.50 | | 1.75 | | 2.00 | | 2.00 | | 2.00 | |
| A/A | From plumbet BACK TO PLATFORM plumbet directly below | Designation | | | A/A-P5 | | A/A-P7.5 | | A/A-P10 | | A/A-P15 | | A/A-P20 | | A/A-(P21-26) | | A/A-P27 | |
| | | Minimum | | | 1.00 | | 1.00 | | 1.00 | | 1.00 | | 1.00 | | 1.00 | | 1.00 | |
| B | From plumbet to POOL WALL or OBSTACLE AT SIDE | Designation | B-P3 | | B-P5 | | B-P7.5 | | B-P10 | | B-P15 | | B-P20 | | C-(P21-26) | | B-P27 | |
| | | Minimum | 3.50 | | 3.75 | | 4.50 | | 5.50 | | 5.50 | | 6.00 | | 6.50 | | 7.00 | |
| C | From plumbet to ADJACENT PLUMMET ¹⁾ | Designation | C-P3 | | C-P5 | | C-P7.5 | | C-P10 | | C-P15 | | C-P20 | | C-(P21-26) | | C-P27 | |
| | | Minimum | 2.50 | | 2.50 | | 2.50 | | 2.50 | | 2.50 | | 2.50 | | 2.50 | | 2.50 | |
| D | From plumbet to POOL WALL or OBSTACLE AHEAD | Designation | D-P3 | | D-P5 | | D-P7.5 | | D-P10 | | D-P15 | | D-P20 | | D-(P21-26) | | D-P27 | |
| | | Minimum | 9.50 | | 10.25 | | 11.00 | | 13.50 | | 14.00 | | 14.00 | | 15.00 | | 15.00 | |
| E | On plumbet, from PLATFORM TO CEILING / PLATFORM ABOVE | Designation | E-P3 | | E-P5 | | E-P7.5 | | E-10 | | E-P15 | | E-P20 | | E-(P21-26) | | E-P27 | |
| | | Minimum | 4.00 | | 4.00 | | 4.00 | | 4.00 | | 4.00 | | 4.00 | | 4.00 | | 4.00 | |
| F | Clear Overhead BEHIND AND EACH SIDE of plumbet | Designation | F-P3 | E-P3 | F-P5 | E-P5 | F-P7.5 | E-P7.5 | F-P10 | E-P10 | F-P15 | E-P15 | F-P20 | E-P20 | F-(P21-26) | E-(P21-26) | F-P27 | E-P27 |
| | | Minimum | 2.75 | 3.50 | 2.75 | 4.00 | 2.75 | 4.00 | 2.75 | 4.00 | 2.75 | 4.00 | 2.75 | 4.00 | 2.75 | 4.00 | 2.75 | 4.00 |
| G | Clear Overhead AHEAD of plumbet | Designation | G-P3 | E-P3 | G-P5 | E-P5 | G-P7.5 | E-P7.5 | G-P10 | E-P10 | G-P15 | E-P15 | G-P20 | E-P20 | G-(P21-26) | E-(P21-26) | G-P27 | E-P27 |
| | | Minimum | 5.00 | 4.00 | 5.00 | 4.00 | 5.00 | 4.00 | 6.00 | 4.00 | 6.00 | 4.00 | 6.00 | 4.00 | 6.00 | 4.00 | 6.00 | 4.00 |
| H | DEPTH OF WATER at plumbet ²⁾ | Designation | H-P3 | | H-P5 | | H-P7.5 | | H-P10 | | H-P15 | | H-20 | | H-(P21-26) | | H-P27 | |
| | | Minimum | 3.60 | | 3.80 | | 4.50 | | 5.00 | | 5.50 | | 5.80 | | 5.80 | | 5.80 | |
| J K | DISTANCE and DEPTH AHEAD of plumbet for all stands | Designation | J-P3 | K-P3 | J-P5 | K-P5 | J-P7.5 | K-P7.5 | J-P10 | K-P10 | J-P15 | K-P15 | J-P20 | K-P20 | J-(P21-26) | K-(P21-26) | J-P27 | K-P27 |
| | | Minimum | 5.50 | 3.40 | 6.00 | 3.60 | 8.00 | 4.30 | 11.00 | 4.80 | 11.50 | 5.30 | 12.00 | 5.60 | 12.00 | 5.60 | 12.00 | 5.60 |
| L M | DISTANCE and DEPTH EACH SIDE of plumbet | Designation | L-P3 | M-P3 | L-P5 | M-P5 | L-7.5 | M-7.5 | L-P10 | M-P10 | L-P15 | M-P15 | L-P20 | M-P20 | L-(P21-26) | M-(P21-26) | L-P27 | M-P27 |
| | | Minimum | 2.30 | 3.40 | 3.50 | 3.60 | 4.50 | 4.30 | 5.25 | 4.80 | 5.50 | 5.30 | 6.00 | 5.60 | 6.50 | 5.60 | 7.00 | 5.60 |
| N | Maximum Slope to reduce dimensions beyond full requirements for pool depth and ceiling height = 30 Degrees | | | | | | | | | | | | | | | | | |

Notes

- The appropriate local authorities must certify that the minimum requirements are observed.
- ¹⁾ The side distance between platforms must not be less than 0.50 metre.
- ³⁾ For High Diving events other than World Aquatics Championships and World Aquatics World Cups the following minimum platform dimensions are accepted: Length 2.0m / width 1.5m; adjacent platform distances between platforms to be adjusted accordingly with respect the 0.50 metre distance between the platforms

- ⁴⁾ in natural surroundings (sea, lakes, rivers etc.) height tolerance: ± 1 metre.
- ⁵⁾ 15.00m is an official height for Junior A competitions and dimensions valid for all heights between 11.00 - 19.00 metres.

| H | DEPTH OF WATER at plummet | Designation | HP-3 | HP-5 | HP-7.5 | HP-10 | HP-15 | H 20 | HP-P21-26 | H-P27 |
|-----------|------------------------------|-------------|------|------|--------|-------|-------|------|-----------|-------|
| | | Minimum | 3.60 | 3.80 | 4.50 | 5.00 | 5.00 | 5.00 | 5.00 | 5.00 |
| Preffered | 4.00 | 4.00 | 4.50 | 5.00 | 5.50 | 5.80 | 5.80 | 5.80 | 5.80 | |

Appendix 3 - Diagram / Temporary Round Pools

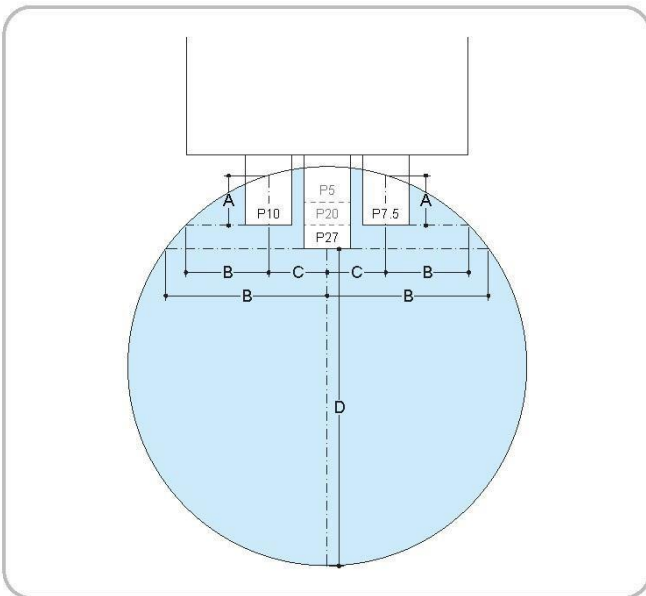
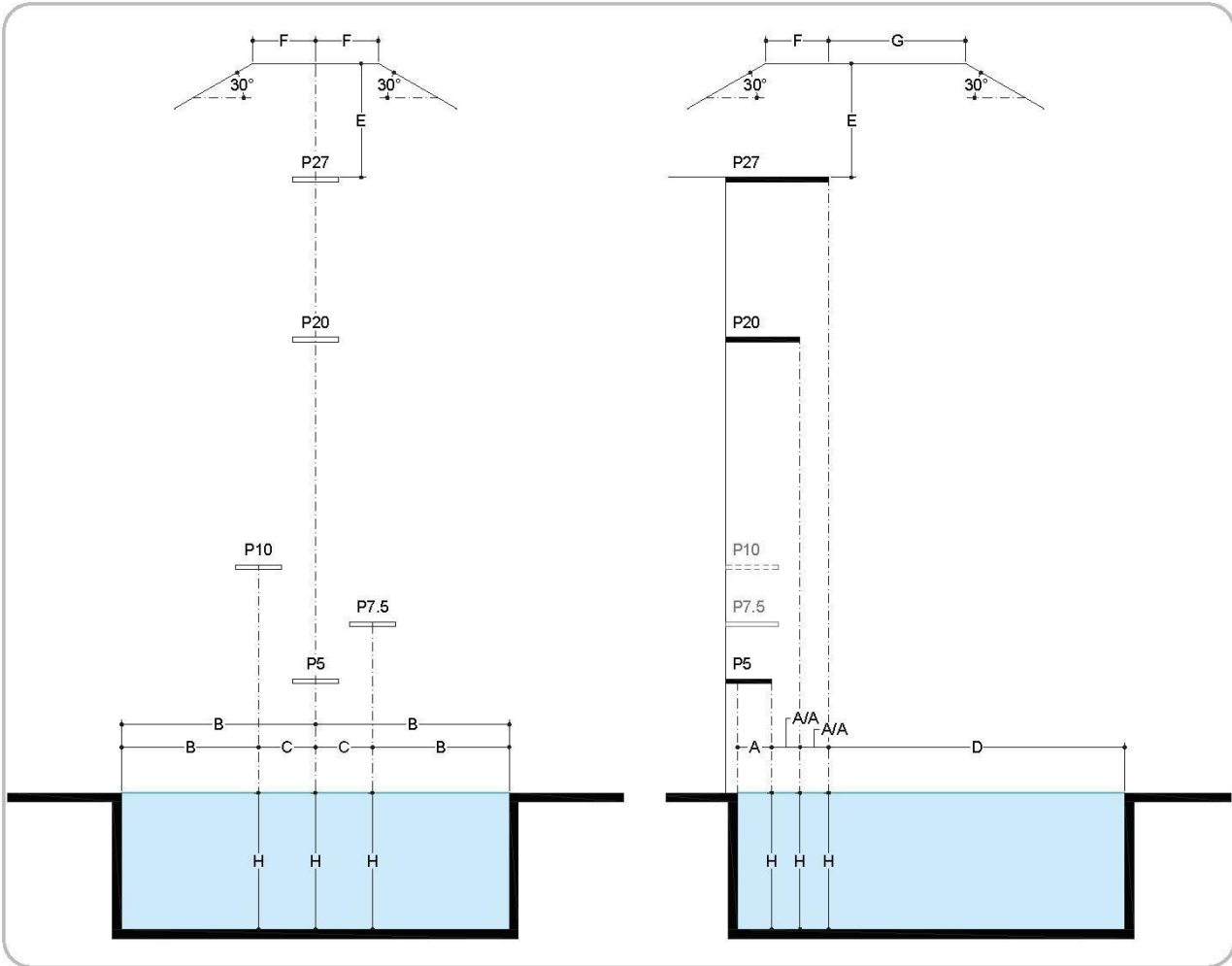

Handrail and Platform Front Edge Detail

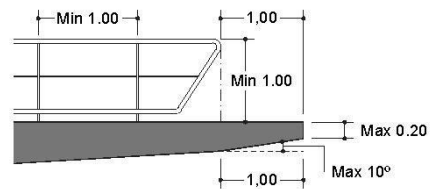
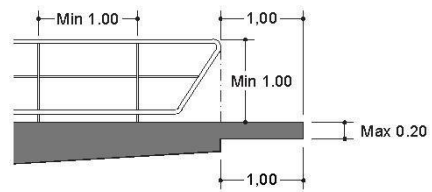

Appendix 4 - Table / Temporary Round Pools / Dimensions

| WORLD AQUATICS | | | PLATFORM | | | | |
|---|--|-----------|----------|--------|--------|--------|--------|
| | | | P 5 | P 7.5 | P 10 | P 20 | P 27 |
| Dimensions for High Diving temporary round pools | | | | | | | |
| Round pool diameter 17 m | Length | Minimum | 5.00 | 5.00 | 5.00 | 5.00 | 5.00 |
| | Width | Minimum | 2.00 | 2.00 | 2.00 | 2.00 | 2.00 |
| | Height | | 5.00 | 7.50 | 10.00 | 20.00 | 27.00 |
| | | Tolerance | ± 0.05 | ± 0.05 | ± 0.05 | ± 0.05 | ± 0.05 |
| A | From plummet BACK TO POOL WALL | | 1.50 | 1.85 | 1.85 | 2.25 | 3.00 |
| A/A | From plummet BACK TO PLATFORM plummet direct below | | | | | 0.75 | 0.75 |
| B | From plummet to POOL WALL AT SIDE | | 4.80 | 3.20 | 3.20 | 5.70 | 6.40 |
| C | From plummet to ADJACENT PLUMMET ¹⁾ | | 2.50 | 2.50 | 2.50 | 2.50 | 2.50 |
| D | From plummet to POOL WALL AHEAD | | 14.00 | 14.00 | 14.00 | 14.00 | 14.00 |
| H | DEPTH OF WATER at plummet | | 5.80 | 5.80 | 5.80 | 5.80 | 5.80 |

Notes

- The appropriate local authorities must certify that the minimum requirements are observed.

- ¹⁾ The side distance between platforms must not be less than 0.50 metre.
- The use of temporary round pools (TRP) is restricted to sanctioned World Aquatics competitions.

Comment

The same dimensions and configuration of the platforms can be achieved in a rectangular pool with the following dimensions: 14.00 x 17.00 metres.

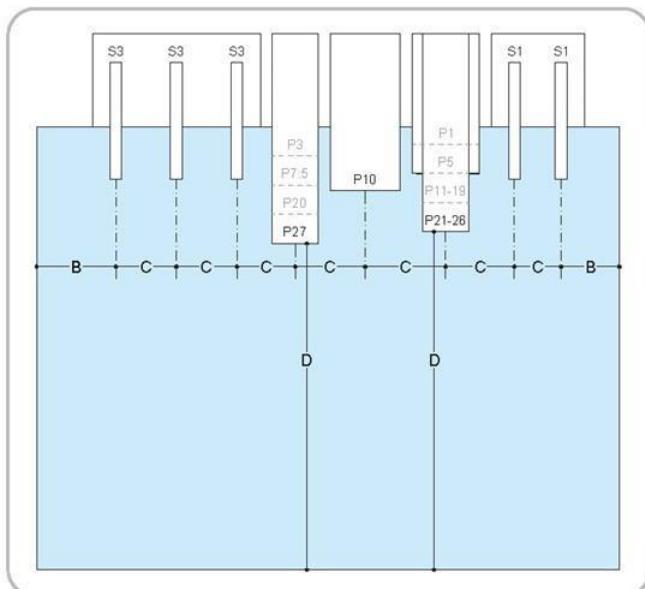
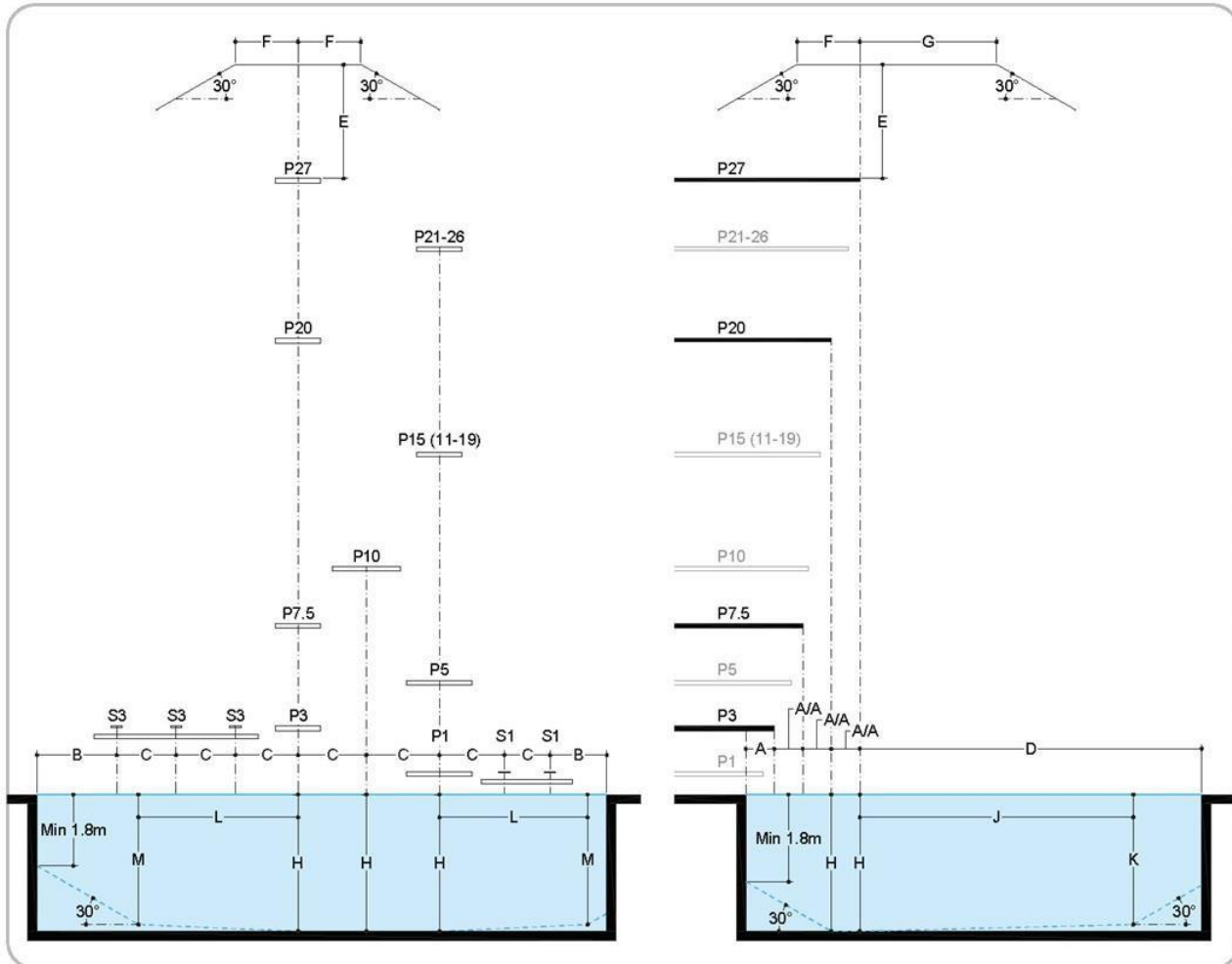
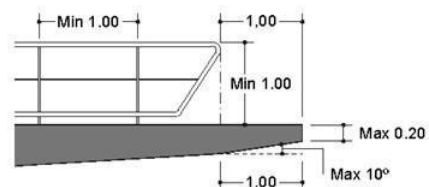
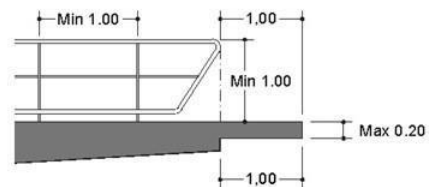
Appendix 5 - Diagram / General Standard Facilities combined with Diving

Handrail and Platform Front Edge Detail

11. DEGREE OF DIFFICULTY – FORMULA AND TABLES
11.1 Degree of Difficulty - Formula and Components

| HIGH DIVING: 12 METERS | | | | | | | | | | | | | | | | | | | | | | | | | | | | | | | | | | | | | | | | | | | | | | | | | | | | | | | | | | | | | | | | | | | | | | | | | | | | | | | | | | | | | | | | | | | | | | | | | | | | | | | | | | | | | | | | | | | | | | | | | | | | | | | | | | | | | | | | | | | | | | | | | | | | | | | | | | | | | | | | | |
|--|---|-----|-----|-----|---|---|----|-----|-----|-----|-----|--|--------|--|---|---|---|---|----|-----|-----|-----|-----|--|--------|--|---|---|---|---|---|-----|-----|-----|-----|--|--------|-----|-----|---|---|---|-----|-----|-----|-----|-----|-----|--------|-----|-----|--------|---|---|-----|-----|-----|-----|--------|-----|--|--------|---|---|-----|-----|-----|-----|-----|-----|--|--------|--|--------|-----|-----|---|----|--------|-----|-----|-----|-----|--------|---|--------|-----|-----|-----|----|---|--------|-----|-----|-----|--------|---|--------|-----|-----|-----|-----|-----|--------|-----|-----|-----|-----|-----|--------|-----|-----|-----|-----|-----|--------|-----|-----|-----|-----|---|---|--------|-----|-----|-----|---|---|----|-----|-----|-----|-----|--|---|-----|-----|--|--|---|-----|-----|--|--|---|-----|-----|--|--|--------|--|---|---|---|---|----|-----|-----|-----|-----|--|
| STANDING DIVES A+B+C+D+E+F=DD | ARMSTAND DIVES A1+B1+C1+D1+E1+F1=DD | | | | | | | | | | | | | | | | | | | | | | | | | | | | | | | | | | | | | | | | | | | | | | | | | | | | | | | | | | | | | | | | | | | | | | | | | | | | | | | | | | | | | | | | | | | | | | | | | | | | | | | | | | | | | | | | | | | | | | | | | | | | | | | | | | | | | | | | | | | | | | | | | | | | | | | | | | | | | | | | |
| FORWARD (GROUP 1) 1 - 51 | FORWARD (GROUP 5) 61 | | | | | | | | | | | | | | | | | | | | | | | | | | | | | | | | | | | | | | | | | | | | | | | | | | | | | | | | | | | | | | | | | | | | | | | | | | | | | | | | | | | | | | | | | | | | | | | | | | | | | | | | | | | | | | | | | | | | | | | | | | | | | | | | | | | | | | | | | | | | | | | | | | | | | | | | | | | | | | | | |
| <p>A. SOMERSAULTS</p> <table border="1"> <tr><td colspan="2">1/2 SS</td></tr> <tr><td>2</td><td>4</td><td>6</td><td>8</td><td>10</td></tr> <tr><td>2.3</td><td>2.6</td><td>3.4</td><td>4.7</td><td></td></tr> </table> <p>B. APPROACH</p> <table border="1"> <tr><td colspan="2">1/2 SS</td></tr> <tr><td>2</td><td>4</td><td>6</td><td>8</td><td>10</td></tr> <tr><td>0.0</td><td>0.0</td><td>0.0</td><td>0.0</td><td></td></tr> </table> <p>C. TWISTS BARANI ENTRY</p> <table border="1"> <tr><td colspan="2">1/2 SS</td></tr> <tr><td>1</td><td>3</td><td>5</td><td>7</td><td>9</td></tr> <tr><td>0.0</td><td>0.1</td><td>0.3</td><td>0.5</td><td></td></tr> </table> <p>D. TWISTS BLIND ENTRY</p> <table border="1"> <tr><td colspan="2">1/2 SS</td></tr> <tr><td>1</td><td>3</td><td>5</td><td>7</td><td>9</td></tr> <tr><td>0.0</td><td>0.1</td><td>0.3</td><td>0.5</td><td></td></tr> </table> <p>E. BLIND ENTRY</p> <table border="1"> <tr><td colspan="2">1/2 SS</td></tr> <tr><td>2</td><td>4</td><td>6</td><td>8</td><td>10</td></tr> <tr><td>0.2</td><td>0.5</td><td>0.8</td><td>1.2</td><td></td></tr> </table> | 1/2 SS | | 2 | 4 | 6 | 8 | 10 | 2.3 | 2.6 | 3.4 | 4.7 | | 1/2 SS | | 2 | 4 | 6 | 8 | 10 | 0.0 | 0.0 | 0.0 | 0.0 | | 1/2 SS | | 1 | 3 | 5 | 7 | 9 | 0.0 | 0.1 | 0.3 | 0.5 | | 1/2 SS | | 1 | 3 | 5 | 7 | 9 | 0.0 | 0.1 | 0.3 | 0.5 | | 1/2 SS | | 2 | 4 | 6 | 8 | 10 | 0.2 | 0.5 | 0.8 | 1.2 | | <p>A1. SOMERSAULTS</p> <table border="1"> <tr><td colspan="2">1/2 SS</td></tr> <tr><td>1</td><td>3</td><td>5</td><td>7</td><td>9</td></tr> <tr><td>2.3</td><td>2.6</td><td>3.4</td><td>4.7</td><td></td></tr> </table> <p>B1. APPROACH</p> <table border="1"> <tr><td colspan="2">1/2 SS</td></tr> <tr><td>1</td><td>3</td><td>5</td><td>7</td><td>9</td></tr> <tr><td>0.0</td><td>0.1</td><td>0.3</td><td>0.5</td><td></td></tr> </table> <p>C1. TWISTS BARANI ENTRY</p> <table border="1"> <tr><td colspan="2">1/2 SS</td></tr> <tr><td>1</td><td>3</td><td>5</td><td>7</td><td>9</td></tr> <tr><td>0.0</td><td>0.1</td><td>0.3</td><td>0.5</td><td></td></tr> </table> <p>D1. TWISTS BLIND ENTRY</p> <table border="1"> <tr><td colspan="2">1/2 SS</td></tr> <tr><td>1</td><td>3</td><td>5</td><td>7</td><td>9</td></tr> <tr><td>0.0</td><td>0.1</td><td>0.3</td><td>0.5</td><td></td></tr> </table> <p>E1. BLIND ENTRY</p> <table border="1"> <tr><td colspan="2">1/2 SS</td></tr> <tr><td>1</td><td>3</td><td>5</td><td>7</td><td>9</td></tr> <tr><td>0.1</td><td>0.4</td><td>0.8</td><td>1.2</td><td></td></tr> </table> | 1/2 SS | | 1 | 3 | 5 | 7 | 9 | 2.3 | 2.6 | 3.4 | 4.7 | | 1/2 SS | | 1 | 3 | 5 | 7 | 9 | 0.0 | 0.1 | 0.3 | 0.5 | | 1/2 SS | | 1 | 3 | 5 | 7 | 9 | 0.0 | 0.1 | 0.3 | 0.5 | | 1/2 SS | | 1 | 3 | 5 | 7 | 9 | 0.0 | 0.1 | 0.3 | 0.5 | | 1/2 SS | | 1 | 3 | 5 | 7 | 9 | 0.1 | 0.4 | 0.8 | 1.2 | | | | | | | | | | | | | | | | | | | | | | | | | | | | | | | | | | | | | | | | | |
| 1/2 SS | | | | | | | | | | | | | | | | | | | | | | | | | | | | | | | | | | | | | | | | | | | | | | | | | | | | | | | | | | | | | | | | | | | | | | | | | | | | | | | | | | | | | | | | | | | | | | | | | | | | | | | | | | | | | | | | | | | | | | | | | | | | | | | | | | | | | | | | | | | | | | | | | | | | | | | | | | | | | | | | | |
| 2 | 4 | 6 | 8 | 10 | | | | | | | | | | | | | | | | | | | | | | | | | | | | | | | | | | | | | | | | | | | | | | | | | | | | | | | | | | | | | | | | | | | | | | | | | | | | | | | | | | | | | | | | | | | | | | | | | | | | | | | | | | | | | | | | | | | | | | | | | | | | | | | | | | | | | | | | | | | | | | | | | | | | | | | | | | | | | |
| 2.3 | 2.6 | 3.4 | 4.7 | | | | | | | | | | | | | | | | | | | | | | | | | | | | | | | | | | | | | | | | | | | | | | | | | | | | | | | | | | | | | | | | | | | | | | | | | | | | | | | | | | | | | | | | | | | | | | | | | | | | | | | | | | | | | | | | | | | | | | | | | | | | | | | | | | | | | | | | | | | | | | | | | | | | | | | | | | | | | | |
| 1/2 SS | | | | | | | | | | | | | | | | | | | | | | | | | | | | | | | | | | | | | | | | | | | | | | | | | | | | | | | | | | | | | | | | | | | | | | | | | | | | | | | | | | | | | | | | | | | | | | | | | | | | | | | | | | | | | | | | | | | | | | | | | | | | | | | | | | | | | | | | | | | | | | | | | | | | | | | | | | | | | | | | | |
| 2 | 4 | 6 | 8 | 10 | | | | | | | | | | | | | | | | | | | | | | | | | | | | | | | | | | | | | | | | | | | | | | | | | | | | | | | | | | | | | | | | | | | | | | | | | | | | | | | | | | | | | | | | | | | | | | | | | | | | | | | | | | | | | | | | | | | | | | | | | | | | | | | | | | | | | | | | | | | | | | | | | | | | | | | | | | | | | |
| 0.0 | 0.0 | 0.0 | 0.0 | | | | | | | | | | | | | | | | | | | | | | | | | | | | | | | | | | | | | | | | | | | | | | | | | | | | | | | | | | | | | | | | | | | | | | | | | | | | | | | | | | | | | | | | | | | | | | | | | | | | | | | | | | | | | | | | | | | | | | | | | | | | | | | | | | | | | | | | | | | | | | | | | | | | | | | | | | | | | | |
| 1/2 SS | | | | | | | | | | | | | | | | | | | | | | | | | | | | | | | | | | | | | | | | | | | | | | | | | | | | | | | | | | | | | | | | | | | | | | | | | | | | | | | | | | | | | | | | | | | | | | | | | | | | | | | | | | | | | | | | | | | | | | | | | | | | | | | | | | | | | | | | | | | | | | | | | | | | | | | | | | | | | | | | | |
| 1 | 3 | 5 | 7 | 9 | | | | | | | | | | | | | | | | | | | | | | | | | | | | | | | | | | | | | | | | | | | | | | | | | | | | | | | | | | | | | | | | | | | | | | | | | | | | | | | | | | | | | | | | | | | | | | | | | | | | | | | | | | | | | | | | | | | | | | | | | | | | | | | | | | | | | | | | | | | | | | | | | | | | | | | | | | | | | |
| 0.0 | 0.1 | 0.3 | 0.5 | | | | | | | | | | | | | | | | | | | | | | | | | | | | | | | | | | | | | | | | | | | | | | | | | | | | | | | | | | | | | | | | | | | | | | | | | | | | | | | | | | | | | | | | | | | | | | | | | | | | | | | | | | | | | | | | | | | | | | | | | | | | | | | | | | | | | | | | | | | | | | | | | | | | | | | | | | | | | | |
| 1/2 SS | | | | | | | | | | | | | | | | | | | | | | | | | | | | | | | | | | | | | | | | | | | | | | | | | | | | | | | | | | | | | | | | | | | | | | | | | | | | | | | | | | | | | | | | | | | | | | | | | | | | | | | | | | | | | | | | | | | | | | | | | | | | | | | | | | | | | | | | | | | | | | | | | | | | | | | | | | | | | | | | | |
| 1 | 3 | 5 | 7 | 9 | | | | | | | | | | | | | | | | | | | | | | | | | | | | | | | | | | | | | | | | | | | | | | | | | | | | | | | | | | | | | | | | | | | | | | | | | | | | | | | | | | | | | | | | | | | | | | | | | | | | | | | | | | | | | | | | | | | | | | | | | | | | | | | | | | | | | | | | | | | | | | | | | | | | | | | | | | | | | |
| 0.0 | 0.1 | 0.3 | 0.5 | | | | | | | | | | | | | | | | | | | | | | | | | | | | | | | | | | | | | | | | | | | | | | | | | | | | | | | | | | | | | | | | | | | | | | | | | | | | | | | | | | | | | | | | | | | | | | | | | | | | | | | | | | | | | | | | | | | | | | | | | | | | | | | | | | | | | | | | | | | | | | | | | | | | | | | | | | | | | | |
| 1/2 SS | | | | | | | | | | | | | | | | | | | | | | | | | | | | | | | | | | | | | | | | | | | | | | | | | | | | | | | | | | | | | | | | | | | | | | | | | | | | | | | | | | | | | | | | | | | | | | | | | | | | | | | | | | | | | | | | | | | | | | | | | | | | | | | | | | | | | | | | | | | | | | | | | | | | | | | | | | | | | | | | | |
| 2 | 4 | 6 | 8 | 10 | | | | | | | | | | | | | | | | | | | | | | | | | | | | | | | | | | | | | | | | | | | | | | | | | | | | | | | | | | | | | | | | | | | | | | | | | | | | | | | | | | | | | | | | | | | | | | | | | | | | | | | | | | | | | | | | | | | | | | | | | | | | | | | | | | | | | | | | | | | | | | | | | | | | | | | | | | | | | |
| 0.2 | 0.5 | 0.8 | 1.2 | | | | | | | | | | | | | | | | | | | | | | | | | | | | | | | | | | | | | | | | | | | | | | | | | | | | | | | | | | | | | | | | | | | | | | | | | | | | | | | | | | | | | | | | | | | | | | | | | | | | | | | | | | | | | | | | | | | | | | | | | | | | | | | | | | | | | | | | | | | | | | | | | | | | | | | | | | | | | | |
| 1/2 SS | | | | | | | | | | | | | | | | | | | | | | | | | | | | | | | | | | | | | | | | | | | | | | | | | | | | | | | | | | | | | | | | | | | | | | | | | | | | | | | | | | | | | | | | | | | | | | | | | | | | | | | | | | | | | | | | | | | | | | | | | | | | | | | | | | | | | | | | | | | | | | | | | | | | | | | | | | | | | | | | | |
| 1 | 3 | 5 | 7 | 9 | | | | | | | | | | | | | | | | | | | | | | | | | | | | | | | | | | | | | | | | | | | | | | | | | | | | | | | | | | | | | | | | | | | | | | | | | | | | | | | | | | | | | | | | | | | | | | | | | | | | | | | | | | | | | | | | | | | | | | | | | | | | | | | | | | | | | | | | | | | | | | | | | | | | | | | | | | | | | |
| 2.3 | 2.6 | 3.4 | 4.7 | | | | | | | | | | | | | | | | | | | | | | | | | | | | | | | | | | | | | | | | | | | | | | | | | | | | | | | | | | | | | | | | | | | | | | | | | | | | | | | | | | | | | | | | | | | | | | | | | | | | | | | | | | | | | | | | | | | | | | | | | | | | | | | | | | | | | | | | | | | | | | | | | | | | | | | | | | | | | | |
| 1/2 SS | | | | | | | | | | | | | | | | | | | | | | | | | | | | | | | | | | | | | | | | | | | | | | | | | | | | | | | | | | | | | | | | | | | | | | | | | | | | | | | | | | | | | | | | | | | | | | | | | | | | | | | | | | | | | | | | | | | | | | | | | | | | | | | | | | | | | | | | | | | | | | | | | | | | | | | | | | | | | | | | | |
| 1 | 3 | 5 | 7 | 9 | | | | | | | | | | | | | | | | | | | | | | | | | | | | | | | | | | | | | | | | | | | | | | | | | | | | | | | | | | | | | | | | | | | | | | | | | | | | | | | | | | | | | | | | | | | | | | | | | | | | | | | | | | | | | | | | | | | | | | | | | | | | | | | | | | | | | | | | | | | | | | | | | | | | | | | | | | | | | |
| 0.0 | 0.1 | 0.3 | 0.5 | | | | | | | | | | | | | | | | | | | | | | | | | | | | | | | | | | | | | | | | | | | | | | | | | | | | | | | | | | | | | | | | | | | | | | | | | | | | | | | | | | | | | | | | | | | | | | | | | | | | | | | | | | | | | | | | | | | | | | | | | | | | | | | | | | | | | | | | | | | | | | | | | | | | | | | | | | | | | | |
| 1/2 SS | | | | | | | | | | | | | | | | | | | | | | | | | | | | | | | | | | | | | | | | | | | | | | | | | | | | | | | | | | | | | | | | | | | | | | | | | | | | | | | | | | | | | | | | | | | | | | | | | | | | | | | | | | | | | | | | | | | | | | | | | | | | | | | | | | | | | | | | | | | | | | | | | | | | | | | | | | | | | | | | | |
| 1 | 3 | 5 | 7 | 9 | | | | | | | | | | | | | | | | | | | | | | | | | | | | | | | | | | | | | | | | | | | | | | | | | | | | | | | | | | | | | | | | | | | | | | | | | | | | | | | | | | | | | | | | | | | | | | | | | | | | | | | | | | | | | | | | | | | | | | | | | | | | | | | | | | | | | | | | | | | | | | | | | | | | | | | | | | | | | |
| 0.0 | 0.1 | 0.3 | 0.5 | | | | | | | | | | | | | | | | | | | | | | | | | | | | | | | | | | | | | | | | | | | | | | | | | | | | | | | | | | | | | | | | | | | | | | | | | | | | | | | | | | | | | | | | | | | | | | | | | | | | | | | | | | | | | | | | | | | | | | | | | | | | | | | | | | | | | | | | | | | | | | | | | | | | | | | | | | | | | | |
| 1/2 SS | | | | | | | | | | | | | | | | | | | | | | | | | | | | | | | | | | | | | | | | | | | | | | | | | | | | | | | | | | | | | | | | | | | | | | | | | | | | | | | | | | | | | | | | | | | | | | | | | | | | | | | | | | | | | | | | | | | | | | | | | | | | | | | | | | | | | | | | | | | | | | | | | | | | | | | | | | | | | | | | | |
| 1 | 3 | 5 | 7 | 9 | | | | | | | | | | | | | | | | | | | | | | | | | | | | | | | | | | | | | | | | | | | | | | | | | | | | | | | | | | | | | | | | | | | | | | | | | | | | | | | | | | | | | | | | | | | | | | | | | | | | | | | | | | | | | | | | | | | | | | | | | | | | | | | | | | | | | | | | | | | | | | | | | | | | | | | | | | | | | |
| 0.0 | 0.1 | 0.3 | 0.5 | | | | | | | | | | | | | | | | | | | | | | | | | | | | | | | | | | | | | | | | | | | | | | | | | | | | | | | | | | | | | | | | | | | | | | | | | | | | | | | | | | | | | | | | | | | | | | | | | | | | | | | | | | | | | | | | | | | | | | | | | | | | | | | | | | | | | | | | | | | | | | | | | | | | | | | | | | | | | | |
| 1/2 SS | | | | | | | | | | | | | | | | | | | | | | | | | | | | | | | | | | | | | | | | | | | | | | | | | | | | | | | | | | | | | | | | | | | | | | | | | | | | | | | | | | | | | | | | | | | | | | | | | | | | | | | | | | | | | | | | | | | | | | | | | | | | | | | | | | | | | | | | | | | | | | | | | | | | | | | | | | | | | | | | | |
| 1 | 3 | 5 | 7 | 9 | | | | | | | | | | | | | | | | | | | | | | | | | | | | | | | | | | | | | | | | | | | | | | | | | | | | | | | | | | | | | | | | | | | | | | | | | | | | | | | | | | | | | | | | | | | | | | | | | | | | | | | | | | | | | | | | | | | | | | | | | | | | | | | | | | | | | | | | | | | | | | | | | | | | | | | | | | | | | |
| 0.1 | 0.4 | 0.8 | 1.2 | | | | | | | | | | | | | | | | | | | | | | | | | | | | | | | | | | | | | | | | | | | | | | | | | | | | | | | | | | | | | | | | | | | | | | | | | | | | | | | | | | | | | | | | | | | | | | | | | | | | | | | | | | | | | | | | | | | | | | | | | | | | | | | | | | | | | | | | | | | | | | | | | | | | | | | | | | | | | | |
| INWARD (GROUP 4) 4 - 54 | BACK (GROUP 5) 62 | | | | | | | | | | | | | | | | | | | | | | | | | | | | | | | | | | | | | | | | | | | | | | | | | | | | | | | | | | | | | | | | | | | | | | | | | | | | | | | | | | | | | | | | | | | | | | | | | | | | | | | | | | | | | | | | | | | | | | | | | | | | | | | | | | | | | | | | | | | | | | | | | | | | | | | | | | | | | | | | |
| <p>A. SOMERSAULTS</p> <table border="1"> <tr><td colspan="2">1/2 SS</td></tr> <tr><td>2</td><td>4</td><td>6</td><td>8</td><td>10</td></tr> <tr><td>2.3</td><td>2.6</td><td>3.4</td><td>4.7</td><td></td></tr> </table> <p>B. APPROACH</p> <table border="1"> <tr><td colspan="2">1/2 SS</td></tr> <tr><td>2</td><td>4</td><td>6</td><td>8</td><td>10</td></tr> <tr><td>0.2</td><td>0.4</td><td>0.6</td><td>0.8</td><td></td></tr> </table> <p>C. TWISTS BARANI ENTRY</p> <table border="1"> <tr><td colspan="2">1/2 SS</td></tr> <tr><td>1</td><td>3</td><td>5</td><td>7</td><td>9</td></tr> <tr><td>0.0</td><td>0.1</td><td>0.3</td><td>0.5</td><td></td></tr> </table> <p>D. TWISTS BLIND ENTRY</p> <table border="1"> <tr><td colspan="2">1/2 SS</td></tr> <tr><td>2</td><td>4</td><td>6</td><td>8</td><td>10</td></tr> <tr><td>2</td><td>2</td><td>1.0</td><td>1.5</td><td>2.3</td></tr> <tr><td>4</td><td>1.7</td><td>2.4</td><td></td><td></td></tr> <tr><td>6</td><td>2.6</td><td></td><td></td><td></td></tr> </table> <p>E. BLIND ENTRY</p> <table border="1"> <tr><td colspan="2">1/2 SS</td></tr> <tr><td>2</td><td>4</td><td>6</td><td>8</td><td>10</td></tr> <tr><td>0.4</td><td>0.6</td><td>0.9</td><td>1.4</td><td></td></tr> </table> | 1/2 SS | | 2 | 4 | 6 | 8 | 10 | 2.3 | 2.6 | 3.4 | 4.7 | | 1/2 SS | | 2 | 4 | 6 | 8 | 10 | 0.2 | 0.4 | 0.6 | 0.8 | | 1/2 SS | | 1 | 3 | 5 | 7 | 9 | 0.0 | 0.1 | 0.3 | 0.5 | | 1/2 SS | | 2 | 4 | 6 | 8 | 10 | 2 | 2 | 1.0 | 1.5 | 2.3 | 4 | 1.7 | 2.4 | | | 6 | 2.6 | | | | 1/2 SS | | 2 | 4 | 6 | 8 | 10 | 0.4 | 0.6 | 0.9 | 1.4 | | <p>A1. SOMERSAULTS</p> <table border="1"> <tr><td colspan="2">1/2 SS</td></tr> <tr><td>1</td><td>3</td><td>5</td><td>7</td><td>9</td></tr> <tr><td>2.3</td><td>2.6</td><td>3.4</td><td>4.7</td><td></td></tr> </table> <p>B1. APPROACH</p> <table border="1"> <tr><td colspan="2">1/2 SS</td></tr> <tr><td>1</td><td>3</td><td>5</td><td>7</td><td>9</td></tr> <tr><td>0.0</td><td>0.0</td><td>0.3</td><td>0.5</td><td></td></tr> </table> <p>C1. TWISTS BARANI ENTRY</p> <table border="1"> <tr><td colspan="2">1/2 SS</td></tr> <tr><td>1</td><td>3</td><td>5</td><td>7</td><td>9</td></tr> <tr><td>0.1</td><td>0.2</td><td>0.4</td><td>0.6</td><td></td></tr> <tr><td>4</td><td>0.7</td><td>1.0</td><td></td><td></td></tr> <tr><td>6</td><td>1.4</td><td>1.8</td><td></td><td></td></tr> <tr><td>8</td><td>2.3</td><td>2.8</td><td></td><td></td></tr> </table> <p>D1. TWISTS BLIND ENTRY</p> <table border="1"> <tr><td colspan="2">1/2 SS</td></tr> <tr><td>1</td><td>3</td><td>5</td><td>7</td><td>9</td></tr> <tr><td>0.3</td><td>0.5</td><td>0.9</td><td>1.3</td><td></td></tr> <tr><td>3</td><td>1.0</td><td>1.5</td><td></td><td></td></tr> <tr><td>5</td><td>1.8</td><td>2.4</td><td></td><td></td></tr> <tr><td>7</td><td>2.8</td><td>3.5</td><td></td><td></td></tr> </table> <p>F1. BACK ROTATION CONTROL ENTRY</p> <table border="1"> <tr><td colspan="2">1/2 SS</td></tr> <tr><td>1</td><td>3</td><td>5</td><td>7</td><td>9</td></tr> <tr><td>0.2</td><td>0.4</td><td>0.7</td><td>1.0</td><td></td></tr> </table> | 1/2 SS | | 1 | 3 | 5 | 7 | 9 | 2.3 | 2.6 | 3.4 | 4.7 | | 1/2 SS | | 1 | 3 | 5 | 7 | 9 | 0.0 | 0.0 | 0.3 | 0.5 | | 1/2 SS | | 1 | 3 | 5 | 7 | 9 | 0.1 | 0.2 | 0.4 | 0.6 | | 4 | 0.7 | 1.0 | | | 6 | 1.4 | 1.8 | | | 8 | 2.3 | 2.8 | | | 1/2 SS | | 1 | 3 | 5 | 7 | 9 | 0.3 | 0.5 | 0.9 | 1.3 | | 3 | 1.0 | 1.5 | | | 5 | 1.8 | 2.4 | | | 7 | 2.8 | 3.5 | | | 1/2 SS | | 1 | 3 | 5 | 7 | 9 | 0.2 | 0.4 | 0.7 | 1.0 | |
| 1/2 SS | | | | | | | | | | | | | | | | | | | | | | | | | | | | | | | | | | | | | | | | | | | | | | | | | | | | | | | | | | | | | | | | | | | | | | | | | | | | | | | | | | | | | | | | | | | | | | | | | | | | | | | | | | | | | | | | | | | | | | | | | | | | | | | | | | | | | | | | | | | | | | | | | | | | | | | | | | | | | | | | | |
| 2 | 4 | 6 | 8 | 10 | | | | | | | | | | | | | | | | | | | | | | | | | | | | | | | | | | | | | | | | | | | | | | | | | | | | | | | | | | | | | | | | | | | | | | | | | | | | | | | | | | | | | | | | | | | | | | | | | | | | | | | | | | | | | | | | | | | | | | | | | | | | | | | | | | | | | | | | | | | | | | | | | | | | | | | | | | | | | |
| 2.3 | 2.6 | 3.4 | 4.7 | | | | | | | | | | | | | | | | | | | | | | | | | | | | | | | | | | | | | | | | | | | | | | | | | | | | | | | | | | | | | | | | | | | | | | | | | | | | | | | | | | | | | | | | | | | | | | | | | | | | | | | | | | | | | | | | | | | | | | | | | | | | | | | | | | | | | | | | | | | | | | | | | | | | | | | | | | | | | | |
| 1/2 SS | | | | | | | | | | | | | | | | | | | | | | | | | | | | | | | | | | | | | | | | | | | | | | | | | | | | | | | | | | | | | | | | | | | | | | | | | | | | | | | | | | | | | | | | | | | | | | | | | | | | | | | | | | | | | | | | | | | | | | | | | | | | | | | | | | | | | | | | | | | | | | | | | | | | | | | | | | | | | | | | | |
| 2 | 4 | 6 | 8 | 10 | | | | | | | | | | | | | | | | | | | | | | | | | | | | | | | | | | | | | | | | | | | | | | | | | | | | | | | | | | | | | | | | | | | | | | | | | | | | | | | | | | | | | | | | | | | | | | | | | | | | | | | | | | | | | | | | | | | | | | | | | | | | | | | | | | | | | | | | | | | | | | | | | | | | | | | | | | | | | |
| 0.2 | 0.4 | 0.6 | 0.8 | | | | | | | | | | | | | | | | | | | | | | | | | | | | | | | | | | | | | | | | | | | | | | | | | | | | | | | | | | | | | | | | | | | | | | | | | | | | | | | | | | | | | | | | | | | | | | | | | | | | | | | | | | | | | | | | | | | | | | | | | | | | | | | | | | | | | | | | | | | | | | | | | | | | | | | | | | | | | | |
| 1/2 SS | | | | | | | | | | | | | | | | | | | | | | | | | | | | | | | | | | | | | | | | | | | | | | | | | | | | | | | | | | | | | | | | | | | | | | | | | | | | | | | | | | | | | | | | | | | | | | | | | | | | | | | | | | | | | | | | | | | | | | | | | | | | | | | | | | | | | | | | | | | | | | | | | | | | | | | | | | | | | | | | | |
| 1 | 3 | 5 | 7 | 9 | | | | | | | | | | | | | | | | | | | | | | | | | | | | | | | | | | | | | | | | | | | | | | | | | | | | | | | | | | | | | | | | | | | | | | | | | | | | | | | | | | | | | | | | | | | | | | | | | | | | | | | | | | | | | | | | | | | | | | | | | | | | | | | | | | | | | | | | | | | | | | | | | | | | | | | | | | | | | |
| 0.0 | 0.1 | 0.3 | 0.5 | | | | | | | | | | | | | | | | | | | | | | | | | | | | | | | | | | | | | | | | | | | | | | | | | | | | | | | | | | | | | | | | | | | | | | | | | | | | | | | | | | | | | | | | | | | | | | | | | | | | | | | | | | | | | | | | | | | | | | | | | | | | | | | | | | | | | | | | | | | | | | | | | | | | | | | | | | | | | | |
| 1/2 SS | | | | | | | | | | | | | | | | | | | | | | | | | | | | | | | | | | | | | | | | | | | | | | | | | | | | | | | | | | | | | | | | | | | | | | | | | | | | | | | | | | | | | | | | | | | | | | | | | | | | | | | | | | | | | | | | | | | | | | | | | | | | | | | | | | | | | | | | | | | | | | | | | | | | | | | | | | | | | | | | | |
| 2 | 4 | 6 | 8 | 10 | | | | | | | | | | | | | | | | | | | | | | | | | | | | | | | | | | | | | | | | | | | | | | | | | | | | | | | | | | | | | | | | | | | | | | | | | | | | | | | | | | | | | | | | | | | | | | | | | | | | | | | | | | | | | | | | | | | | | | | | | | | | | | | | | | | | | | | | | | | | | | | | | | | | | | | | | | | | | |
| 2 | 2 | 1.0 | 1.5 | 2.3 | | | | | | | | | | | | | | | | | | | | | | | | | | | | | | | | | | | | | | | | | | | | | | | | | | | | | | | | | | | | | | | | | | | | | | | | | | | | | | | | | | | | | | | | | | | | | | | | | | | | | | | | | | | | | | | | | | | | | | | | | | | | | | | | | | | | | | | | | | | | | | | | | | | | | | | | | | | | | |
| 4 | 1.7 | 2.4 | | | | | | | | | | | | | | | | | | | | | | | | | | | | | | | | | | | | | | | | | | | | | | | | | | | | | | | | | | | | | | | | | | | | | | | | | | | | | | | | | | | | | | | | | | | | | | | | | | | | | | | | | | | | | | | | | | | | | | | | | | | | | | | | | | | | | | | | | | | | | | | | | | | | | | | | | | | | | | | |
| 6 | 2.6 | | | | | | | | | | | | | | | | | | | | | | | | | | | | | | | | | | | | | | | | | | | | | | | | | | | | | | | | | | | | | | | | | | | | | | | | | | | | | | | | | | | | | | | | | | | | | | | | | | | | | | | | | | | | | | | | | | | | | | | | | | | | | | | | | | | | | | | | | | | | | | | | | | | | | | | | | | | | | | | | |
| 1/2 SS | | | | | | | | | | | | | | | | | | | | | | | | | | | | | | | | | | | | | | | | | | | | | | | | | | | | | | | | | | | | | | | | | | | | | | | | | | | | | | | | | | | | | | | | | | | | | | | | | | | | | | | | | | | | | | | | | | | | | | | | | | | | | | | | | | | | | | | | | | | | | | | | | | | | | | | | | | | | | | | | | |
| 2 | 4 | 6 | 8 | 10 | | | | | | | | | | | | | | | | | | | | | | | | | | | | | | | | | | | | | | | | | | | | | | | | | | | | | | | | | | | | | | | | | | | | | | | | | | | | | | | | | | | | | | | | | | | | | | | | | | | | | | | | | | | | | | | | | | | | | | | | | | | | | | | | | | | | | | | | | | | | | | | | | | | | | | | | | | | | | |
| 0.4 | 0.6 | 0.9 | 1.4 | | | | | | | | | | | | | | | | | | | | | | | | | | | | | | | | | | | | | | | | | | | | | | | | | | | | | | | | | | | | | | | | | | | | | | | | | | | | | | | | | | | | | | | | | | | | | | | | | | | | | | | | | | | | | | | | | | | | | | | | | | | | | | | | | | | | | | | | | | | | | | | | | | | | | | | | | | | | | | |
| 1/2 SS | | | | | | | | | | | | | | | | | | | | | | | | | | | | | | | | | | | | | | | | | | | | | | | | | | | | | | | | | | | | | | | | | | | | | | | | | | | | | | | | | | | | | | | | | | | | | | | | | | | | | | | | | | | | | | | | | | | | | | | | | | | | | | | | | | | | | | | | | | | | | | | | | | | | | | | | | | | | | | | | | |
| 1 | 3 | 5 | 7 | 9 | | | | | | | | | | | | | | | | | | | | | | | | | | | | | | | | | | | | | | | | | | | | | | | | | | | | | | | | | | | | | | | | | | | | | | | | | | | | | | | | | | | | | | | | | | | | | | | | | | | | | | | | | | | | | | | | | | | | | | | | | | | | | | | | | | | | | | | | | | | | | | | | | | | | | | | | | | | | | |
| 2.3 | 2.6 | 3.4 | 4.7 | | | | | | | | | | | | | | | | | | | | | | | | | | | | | | | | | | | | | | | | | | | | | | | | | | | | | | | | | | | | | | | | | | | | | | | | | | | | | | | | | | | | | | | | | | | | | | | | | | | | | | | | | | | | | | | | | | | | | | | | | | | | | | | | | | | | | | | | | | | | | | | | | | | | | | | | | | | | | | |
| 1/2 SS | | | | | | | | | | | | | | | | | | | | | | | | | | | | | | | | | | | | | | | | | | | | | | | | | | | | | | | | | | | | | | | | | | | | | | | | | | | | | | | | | | | | | | | | | | | | | | | | | | | | | | | | | | | | | | | | | | | | | | | | | | | | | | | | | | | | | | | | | | | | | | | | | | | | | | | | | | | | | | | | | |
| 1 | 3 | 5 | 7 | 9 | | | | | | | | | | | | | | | | | | | | | | | | | | | | | | | | | | | | | | | | | | | | | | | | | | | | | | | | | | | | | | | | | | | | | | | | | | | | | | | | | | | | | | | | | | | | | | | | | | | | | | | | | | | | | | | | | | | | | | | | | | | | | | | | | | | | | | | | | | | | | | | | | | | | | | | | | | | | | |
| 0.0 | 0.0 | 0.3 | 0.5 | | | | | | | | | | | | | | | | | | | | | | | | | | | | | | | | | | | | | | | | | | | | | | | | | | | | | | | | | | | | | | | | | | | | | | | | | | | | | | | | | | | | | | | | | | | | | | | | | | | | | | | | | | | | | | | | | | | | | | | | | | | | | | | | | | | | | | | | | | | | | | | | | | | | | | | | | | | | | | |
| 1/2 SS | | | | | | | | | | | | | | | | | | | | | | | | | | | | | | | | | | | | | | | | | | | | | | | | | | | | | | | | | | | | | | | | | | | | | | | | | | | | | | | | | | | | | | | | | | | | | | | | | | | | | | | | | | | | | | | | | | | | | | | | | | | | | | | | | | | | | | | | | | | | | | | | | | | | | | | | | | | | | | | | | |
| 1 | 3 | 5 | 7 | 9 | | | | | | | | | | | | | | | | | | | | | | | | | | | | | | | | | | | | | | | | | | | | | | | | | | | | | | | | | | | | | | | | | | | | | | | | | | | | | | | | | | | | | | | | | | | | | | | | | | | | | | | | | | | | | | | | | | | | | | | | | | | | | | | | | | | | | | | | | | | | | | | | | | | | | | | | | | | | | |
| 0.1 | 0.2 | 0.4 | 0.6 | | | | | | | | | | | | | | | | | | | | | | | | | | | | | | | | | | | | | | | | | | | | | | | | | | | | | | | | | | | | | | | | | | | | | | | | | | | | | | | | | | | | | | | | | | | | | | | | | | | | | | | | | | | | | | | | | | | | | | | | | | | | | | | | | | | | | | | | | | | | | | | | | | | | | | | | | | | | | | |
| 4 | 0.7 | 1.0 | | | | | | | | | | | | | | | | | | | | | | | | | | | | | | | | | | | | | | | | | | | | | | | | | | | | | | | | | | | | | | | | | | | | | | | | | | | | | | | | | | | | | | | | | | | | | | | | | | | | | | | | | | | | | | | | | | | | | | | | | | | | | | | | | | | | | | | | | | | | | | | | | | | | | | | | | | | | | | | |
| 6 | 1.4 | 1.8 | | | | | | | | | | | | | | | | | | | | | | | | | | | | | | | | | | | | | | | | | | | | | | | | | | | | | | | | | | | | | | | | | | | | | | | | | | | | | | | | | | | | | | | | | | | | | | | | | | | | | | | | | | | | | | | | | | | | | | | | | | | | | | | | | | | | | | | | | | | | | | | | | | | | | | | | | | | | | | | |
| 8 | 2.3 | 2.8 | | | | | | | | | | | | | | | | | | | | | | | | | | | | | | | | | | | | | | | | | | | | | | | | | | | | | | | | | | | | | | | | | | | | | | | | | | | | | | | | | | | | | | | | | | | | | | | | | | | | | | | | | | | | | | | | | | | | | | | | | | | | | | | | | | | | | | | | | | | | | | | | | | | | | | | | | | | | | | | |
| 1/2 SS | | | | | | | | | | | | | | | | | | | | | | | | | | | | | | | | | | | | | | | | | | | | | | | | | | | | | | | | | | | | | | | | | | | | | | | | | | | | | | | | | | | | | | | | | | | | | | | | | | | | | | | | | | | | | | | | | | | | | | | | | | | | | | | | | | | | | | | | | | | | | | | | | | | | | | | | | | | | | | | | | |
| 1 | 3 | 5 | 7 | 9 | | | | | | | | | | | | | | | | | | | | | | | | | | | | | | | | | | | | | | | | | | | | | | | | | | | | | | | | | | | | | | | | | | | | | | | | | | | | | | | | | | | | | | | | | | | | | | | | | | | | | | | | | | | | | | | | | | | | | | | | | | | | | | | | | | | | | | | | | | | | | | | | | | | | | | | | | | | | | |
| 0.3 | 0.5 | 0.9 | 1.3 | | | | | | | | | | | | | | | | | | | | | | | | | | | | | | | | | | | | | | | | | | | | | | | | | | | | | | | | | | | | | | | | | | | | | | | | | | | | | | | | | | | | | | | | | | | | | | | | | | | | | | | | | | | | | | | | | | | | | | | | | | | | | | | | | | | | | | | | | | | | | | | | | | | | | | | | | | | | | | |
| 3 | 1.0 | 1.5 | | | | | | | | | | | | | | | | | | | | | | | | | | | | | | | | | | | | | | | | | | | | | | | | | | | | | | | | | | | | | | | | | | | | | | | | | | | | | | | | | | | | | | | | | | | | | | | | | | | | | | | | | | | | | | | | | | | | | | | | | | | | | | | | | | | | | | | | | | | | | | | | | | | | | | | | | | | | | | | |
| 5 | 1.8 | 2.4 | | | | | | | | | | | | | | | | | | | | | | | | | | | | | | | | | | | | | | | | | | | | | | | | | | | | | | | | | | | | | | | | | | | | | | | | | | | | | | | | | | | | | | | | | | | | | | | | | | | | | | | | | | | | | | | | | | | | | | | | | | | | | | | | | | | | | | | | | | | | | | | | | | | | | | | | | | | | | | | |
| 7 | 2.8 | 3.5 | | | | | | | | | | | | | | | | | | | | | | | | | | | | | | | | | | | | | | | | | | | | | | | | | | | | | | | | | | | | | | | | | | | | | | | | | | | | | | | | | | | | | | | | | | | | | | | | | | | | | | | | | | | | | | | | | | | | | | | | | | | | | | | | | | | | | | | | | | | | | | | | | | | | | | | | | | | | | | | |
| 1/2 SS | | | | | | | | | | | | | | | | | | | | | | | | | | | | | | | | | | | | | | | | | | | | | | | | | | | | | | | | | | | | | | | | | | | | | | | | | | | | | | | | | | | | | | | | | | | | | | | | | | | | | | | | | | | | | | | | | | | | | | | | | | | | | | | | | | | | | | | | | | | | | | | | | | | | | | | | | | | | | | | | | |
| 1 | 3 | 5 | 7 | 9 | | | | | | | | | | | | | | | | | | | | | | | | | | | | | | | | | | | | | | | | | | | | | | | | | | | | | | | | | | | | | | | | | | | | | | | | | | | | | | | | | | | | | | | | | | | | | | | | | | | | | | | | | | | | | | | | | | | | | | | | | | | | | | | | | | | | | | | | | | | | | | | | | | | | | | | | | | | | | |
| 0.2 | 0.4 | 0.7 | 1.0 | | | | | | | | | | | | | | | | | | | | | | | | | | | | | | | | | | | | | | | | | | | | | | | | | | | | | | | | | | | | | | | | | | | | | | | | | | | | | | | | | | | | | | | | | | | | | | | | | | | | | | | | | | | | | | | | | | | | | | | | | | | | | | | | | | | | | | | | | | | | | | | | | | | | | | | | | | | | | | |
| FORWARD (GROUP 2) 1 - 51 | REVERSE (GROUP 3) 3 - 53 | | | | | | | | | | | | | | | | | | | | | | | | | | | | | | | | | | | | | | | | | | | | | | | | | | | | | | | | | | | | | | | | | | | | | | | | | | | | | | | | | | | | | | | | | | | | | | | | | | | | | | | | | | | | | | | | | | | | | | | | | | | | | | | | | | | | | | | | | | | | | | | | | | | | | | | | | | | | | | | | |
| <p>A. SOMERSAULTS</p> <table border="1"> <tr><td colspan="2">1/2 SS</td></tr> <tr><td>2</td><td>4</td><td>6</td><td>8</td><td>10</td></tr> <tr><td>2.3</td><td>2.6</td><td>3.4</td><td>4.7</td><td></td></tr> </table> <p>B. APPROACH</p> <table border="1"> <tr><td colspan="2">1/2 SS</td></tr> <tr><td>2</td><td>4</td><td>6</td><td>8</td><td>10</td></tr> <tr><td>0.0</td><td>0.0</td><td>0.0</td><td>0.0</td><td></td></tr> </table> <p>C. TWISTS BARANI ENTRY</p> <table border="1"> <tr><td colspan="2">1/2 SS</td></tr> <tr><td>1</td><td>3</td><td>5</td><td>7</td><td>9</td></tr> <tr><td>0.0</td><td>0.0</td><td>0.0</td><td>0.0</td><td></td></tr> </table> <p>D. TWISTS BLIND ENTRY</p> <table border="1"> <tr><td colspan="2">1/2 SS</td></tr> <tr><td>2</td><td>4</td><td>6</td><td>8</td><td>10</td></tr> <tr><td>0.8</td><td>1.3</td><td>2.1</td><td></td><td></td></tr> <tr><td>4</td><td>1.4</td><td>2.1</td><td></td><td></td></tr> <tr><td>6</td><td>2.2</td><td></td><td></td><td></td></tr> </table> <p>E. BLIND ENTRY</p> <table border="1"> <tr><td colspan="2">1/2 SS</td></tr> <tr><td>2</td><td>4</td><td>6</td><td>8</td><td>10</td></tr> <tr><td>0.2</td><td>0.5</td><td>0.8</td><td>1.2</td><td></td></tr> </table> | 1/2 SS | | 2 | 4 | 6 | 8 | 10 | 2.3 | 2.6 | 3.4 | 4.7 | | 1/2 SS | | 2 | 4 | 6 | 8 | 10 | 0.0 | 0.0 | 0.0 | 0.0 | | 1/2 SS | | 1 | 3 | 5 | 7 | 9 | 0.0 | 0.0 | 0.0 | 0.0 | | 1/2 SS | | 2 | 4 | 6 | 8 | 10 | 0.8 | 1.3 | 2.1 | | | 4 | 1.4 | 2.1 | | | 6 | 2.2 | | | | 1/2 SS | | 2 | 4 | 6 | 8 | 10 | 0.2 | 0.5 | 0.8 | 1.2 | | <p>A. SOMERSAULTS</p> <table border="1"> <tr><td colspan="2">1/2 SS</td></tr> <tr><td>2</td><td>4</td><td>6</td><td>8</td><td>10</td></tr> <tr><td>2.3</td><td>2.6</td><td>3.4</td><td>4.7</td><td></td></tr> </table> <p>B. APPROACH</p> <table border="1"> <tr><td colspan="2">1/2 SS</td></tr> <tr><td>2</td><td>4</td><td>6</td><td>8</td><td>10</td></tr> <tr><td>0.2</td><td>0.3</td><td>0.5</td><td>0.7</td><td></td></tr> </table> <p>C. TWISTS BARANI ENTRY</p> <table border="1"> <tr><td colspan="2">1/2 SS</td></tr> <tr><td>1</td><td>3</td><td>5</td><td>7</td><td>9</td></tr> <tr><td>0.1</td><td>0.2</td><td>0.3</td><td>0.4</td><td></td></tr> <tr><td>4</td><td>0.6</td><td>0.9</td><td></td><td></td></tr> <tr><td>6</td><td>1.2</td><td>1.7</td><td></td><td></td></tr> <tr><td>8</td><td>2.0</td><td>2.7</td><td></td><td></td></tr> </table> <p>D. TWISTS BLIND ENTRY</p> <table border="1"> <tr><td colspan="2">1/2 SS</td></tr> <tr><td>2</td><td>4</td><td>6</td><td>8</td><td>10</td></tr> <tr><td>0.3</td><td>0.5</td><td>0.8</td><td>1.1</td><td></td></tr> <tr><td>3</td><td>0.9</td><td>1.4</td><td></td><td></td></tr> <tr><td>5</td><td>1.6</td><td>2.3</td><td></td><td></td></tr> <tr><td>7</td><td>2.5</td><td>3.4</td><td></td><td></td></tr> </table> <p>F. BACK ROTATION CONTROL ENTRY</p> <table border="1"> <tr><td colspan="2">1/2 SS</td></tr> <tr><td>2</td><td>4</td><td>6</td><td>8</td><td>10</td></tr> <tr><td>0.1</td><td>0.2</td><td>0.5</td><td>0.8</td><td></td></tr> </table> | 1/2 SS | | 2 | 4 | 6 | 8 | 10 | 2.3 | 2.6 | 3.4 | 4.7 | | 1/2 SS | | 2 | 4 | 6 | 8 | 10 | 0.2 | 0.3 | 0.5 | 0.7 | | 1/2 SS | | 1 | 3 | 5 | 7 | 9 | 0.1 | 0.2 | 0.3 | 0.4 | | 4 | 0.6 | 0.9 | | | 6 | 1.2 | 1.7 | | | 8 | 2.0 | 2.7 | | | 1/2 SS | | 2 | 4 | 6 | 8 | 10 | 0.3 | 0.5 | 0.8 | 1.1 | | 3 | 0.9 | 1.4 | | | 5 | 1.6 | 2.3 | | | 7 | 2.5 | 3.4 | | | 1/2 SS | | 2 | 4 | 6 | 8 | 10 | 0.1 | 0.2 | 0.5 | 0.8 | |
| 1/2 SS | | | | | | | | | | | | | | | | | | | | | | | | | | | | | | | | | | | | | | | | | | | | | | | | | | | | | | | | | | | | | | | | | | | | | | | | | | | | | | | | | | | | | | | | | | | | | | | | | | | | | | | | | | | | | | | | | | | | | | | | | | | | | | | | | | | | | | | | | | | | | | | | | | | | | | | | | | | | | | | | | |
| 2 | 4 | 6 | 8 | 10 | | | | | | | | | | | | | | | | | | | | | | | | | | | | | | | | | | | | | | | | | | | | | | | | | | | | | | | | | | | | | | | | | | | | | | | | | | | | | | | | | | | | | | | | | | | | | | | | | | | | | | | | | | | | | | | | | | | | | | | | | | | | | | | | | | | | | | | | | | | | | | | | | | | | | | | | | | | | | |
| 2.3 | 2.6 | 3.4 | 4.7 | | | | | | | | | | | | | | | | | | | | | | | | | | | | | | | | | | | | | | | | | | | | | | | | | | | | | | | | | | | | | | | | | | | | | | | | | | | | | | | | | | | | | | | | | | | | | | | | | | | | | | | | | | | | | | | | | | | | | | | | | | | | | | | | | | | | | | | | | | | | | | | | | | | | | | | | | | | | | | |
| 1/2 SS | | | | | | | | | | | | | | | | | | | | | | | | | | | | | | | | | | | | | | | | | | | | | | | | | | | | | | | | | | | | | | | | | | | | | | | | | | | | | | | | | | | | | | | | | | | | | | | | | | | | | | | | | | | | | | | | | | | | | | | | | | | | | | | | | | | | | | | | | | | | | | | | | | | | | | | | | | | | | | | | | |
| 2 | 4 | 6 | 8 | 10 | | | | | | | | | | | | | | | | | | | | | | | | | | | | | | | | | | | | | | | | | | | | | | | | | | | | | | | | | | | | | | | | | | | | | | | | | | | | | | | | | | | | | | | | | | | | | | | | | | | | | | | | | | | | | | | | | | | | | | | | | | | | | | | | | | | | | | | | | | | | | | | | | | | | | | | | | | | | | |
| 0.0 | 0.0 | 0.0 | 0.0 | | | | | | | | | | | | | | | | | | | | | | | | | | | | | | | | | | | | | | | | | | | | | | | | | | | | | | | | | | | | | | | | | | | | | | | | | | | | | | | | | | | | | | | | | | | | | | | | | | | | | | | | | | | | | | | | | | | | | | | | | | | | | | | | | | | | | | | | | | | | | | | | | | | | | | | | | | | | | | |
| 1/2 SS | | | | | | | | | | | | | | | | | | | | | | | | | | | | | | | | | | | | | | | | | | | | | | | | | | | | | | | | | | | | | | | | | | | | | | | | | | | | | | | | | | | | | | | | | | | | | | | | | | | | | | | | | | | | | | | | | | | | | | | | | | | | | | | | | | | | | | | | | | | | | | | | | | | | | | | | | | | | | | | | | |
| 1 | 3 | 5 | 7 | 9 | | | | | | | | | | | | | | | | | | | | | | | | | | | | | | | | | | | | | | | | | | | | | | | | | | | | | | | | | | | | | | | | | | | | | | | | | | | | | | | | | | | | | | | | | | | | | | | | | | | | | | | | | | | | | | | | | | | | | | | | | | | | | | | | | | | | | | | | | | | | | | | | | | | | | | | | | | | | | |
| 0.0 | 0.0 | 0.0 | 0.0 | | | | | | | | | | | | | | | | | | | | | | | | | | | | | | | | | | | | | | | | | | | | | | | | | | | | | | | | | | | | | | | | | | | | | | | | | | | | | | | | | | | | | | | | | | | | | | | | | | | | | | | | | | | | | | | | | | | | | | | | | | | | | | | | | | | | | | | | | | | | | | | | | | | | | | | | | | | | | | |
| 1/2 SS | | | | | | | | | | | | | | | | | | | | | | | | | | | | | | | | | | | | | | | | | | | | | | | | | | | | | | | | | | | | | | | | | | | | | | | | | | | | | | | | | | | | | | | | | | | | | | | | | | | | | | | | | | | | | | | | | | | | | | | | | | | | | | | | | | | | | | | | | | | | | | | | | | | | | | | | | | | | | | | | | |
| 2 | 4 | 6 | 8 | 10 | | | | | | | | | | | | | | | | | | | | | | | | | | | | | | | | | | | | | | | | | | | | | | | | | | | | | | | | | | | | | | | | | | | | | | | | | | | | | | | | | | | | | | | | | | | | | | | | | | | | | | | | | | | | | | | | | | | | | | | | | | | | | | | | | | | | | | | | | | | | | | | | | | | | | | | | | | | | | |
| 0.8 | 1.3 | 2.1 | | | | | | | | | | | | | | | | | | | | | | | | | | | | | | | | | | | | | | | | | | | | | | | | | | | | | | | | | | | | | | | | | | | | | | | | | | | | | | | | | | | | | | | | | | | | | | | | | | | | | | | | | | | | | | | | | | | | | | | | | | | | | | | | | | | | | | | | | | | | | | | | | | | | | | | | | | | | | | | |
| 4 | 1.4 | 2.1 | | | | | | | | | | | | | | | | | | | | | | | | | | | | | | | | | | | | | | | | | | | | | | | | | | | | | | | | | | | | | | | | | | | | | | | | | | | | | | | | | | | | | | | | | | | | | | | | | | | | | | | | | | | | | | | | | | | | | | | | | | | | | | | | | | | | | | | | | | | | | | | | | | | | | | | | | | | | | | | |
| 6 | 2.2 | | | | | | | | | | | | | | | | | | | | | | | | | | | | | | | | | | | | | | | | | | | | | | | | | | | | | | | | | | | | | | | | | | | | | | | | | | | | | | | | | | | | | | | | | | | | | | | | | | | | | | | | | | | | | | | | | | | | | | | | | | | | | | | | | | | | | | | | | | | | | | | | | | | | | | | | | | | | | | | | |
| 1/2 SS | | | | | | | | | | | | | | | | | | | | | | | | | | | | | | | | | | | | | | | | | | | | | | | | | | | | | | | | | | | | | | | | | | | | | | | | | | | | | | | | | | | | | | | | | | | | | | | | | | | | | | | | | | | | | | | | | | | | | | | | | | | | | | | | | | | | | | | | | | | | | | | | | | | | | | | | | | | | | | | | | |
| 2 | 4 | 6 | 8 | 10 | | | | | | | | | | | | | | | | | | | | | | | | | | | | | | | | | | | | | | | | | | | | | | | | | | | | | | | | | | | | | | | | | | | | | | | | | | | | | | | | | | | | | | | | | | | | | | | | | | | | | | | | | | | | | | | | | | | | | | | | | | | | | | | | | | | | | | | | | | | | | | | | | | | | | | | | | | | | | |
| 0.2 | 0.5 | 0.8 | 1.2 | | | | | | | | | | | | | | | | | | | | | | | | | | | | | | | | | | | | | | | | | | | | | | | | | | | | | | | | | | | | | | | | | | | | | | | | | | | | | | | | | | | | | | | | | | | | | | | | | | | | | | | | | | | | | | | | | | | | | | | | | | | | | | | | | | | | | | | | | | | | | | | | | | | | | | | | | | | | | | |
| 1/2 SS | | | | | | | | | | | | | | | | | | | | | | | | | | | | | | | | | | | | | | | | | | | | | | | | | | | | | | | | | | | | | | | | | | | | | | | | | | | | | | | | | | | | | | | | | | | | | | | | | | | | | | | | | | | | | | | | | | | | | | | | | | | | | | | | | | | | | | | | | | | | | | | | | | | | | | | | | | | | | | | | | |
| 2 | 4 | 6 | 8 | 10 | | | | | | | | | | | | | | | | | | | | | | | | | | | | | | | | | | | | | | | | | | | | | | | | | | | | | | | | | | | | | | | | | | | | | | | | | | | | | | | | | | | | | | | | | | | | | | | | | | | | | | | | | | | | | | | | | | | | | | | | | | | | | | | | | | | | | | | | | | | | | | | | | | | | | | | | | | | | | |
| 2.3 | 2.6 | 3.4 | 4.7 | | | | | | | | | | | | | | | | | | | | | | | | | | | | | | | | | | | | | | | | | | | | | | | | | | | | | | | | | | | | | | | | | | | | | | | | | | | | | | | | | | | | | | | | | | | | | | | | | | | | | | | | | | | | | | | | | | | | | | | | | | | | | | | | | | | | | | | | | | | | | | | | | | | | | | | | | | | | | | |
| 1/2 SS | | | | | | | | | | | | | | | | | | | | | | | | | | | | | | | | | | | | | | | | | | | | | | | | | | | | | | | | | | | | | | | | | | | | | | | | | | | | | | | | | | | | | | | | | | | | | | | | | | | | | | | | | | | | | | | | | | | | | | | | | | | | | | | | | | | | | | | | | | | | | | | | | | | | | | | | | | | | | | | | | |
| 2 | 4 | 6 | 8 | 10 | | | | | | | | | | | | | | | | | | | | | | | | | | | | | | | | | | | | | | | | | | | | | | | | | | | | | | | | | | | | | | | | | | | | | | | | | | | | | | | | | | | | | | | | | | | | | | | | | | | | | | | | | | | | | | | | | | | | | | | | | | | | | | | | | | | | | | | | | | | | | | | | | | | | | | | | | | | | | |
| 0.2 | 0.3 | 0.5 | 0.7 | | | | | | | | | | | | | | | | | | | | | | | | | | | | | | | | | | | | | | | | | | | | | | | | | | | | | | | | | | | | | | | | | | | | | | | | | | | | | | | | | | | | | | | | | | | | | | | | | | | | | | | | | | | | | | | | | | | | | | | | | | | | | | | | | | | | | | | | | | | | | | | | | | | | | | | | | | | | | | |
| 1/2 SS | | | | | | | | | | | | | | | | | | | | | | | | | | | | | | | | | | | | | | | | | | | | | | | | | | | | | | | | | | | | | | | | | | | | | | | | | | | | | | | | | | | | | | | | | | | | | | | | | | | | | | | | | | | | | | | | | | | | | | | | | | | | | | | | | | | | | | | | | | | | | | | | | | | | | | | | | | | | | | | | | |
| 1 | 3 | 5 | 7 | 9 | | | | | | | | | | | | | | | | | | | | | | | | | | | | | | | | | | | | | | | | | | | | | | | | | | | | | | | | | | | | | | | | | | | | | | | | | | | | | | | | | | | | | | | | | | | | | | | | | | | | | | | | | | | | | | | | | | | | | | | | | | | | | | | | | | | | | | | | | | | | | | | | | | | | | | | | | | | | | |
| 0.1 | 0.2 | 0.3 | 0.4 | | | | | | | | | | | | | | | | | | | | | | | | | | | | | | | | | | | | | | | | | | | | | | | | | | | | | | | | | | | | | | | | | | | | | | | | | | | | | | | | | | | | | | | | | | | | | | | | | | | | | | | | | | | | | | | | | | | | | | | | | | | | | | | | | | | | | | | | | | | | | | | | | | | | | | | | | | | | | | |
| 4 | 0.6 | 0.9 | | | | | | | | | | | | | | | | | | | | | | | | | | | | | | | | | | | | | | | | | | | | | | | | | | | | | | | | | | | | | | | | | | | | | | | | | | | | | | | | | | | | | | | | | | | | | | | | | | | | | | | | | | | | | | | | | | | | | | | | | | | | | | | | | | | | | | | | | | | | | | | | | | | | | | | | | | | | | | | |
| 6 | 1.2 | 1.7 | | | | | | | | | | | | | | | | | | | | | | | | | | | | | | | | | | | | | | | | | | | | | | | | | | | | | | | | | | | | | | | | | | | | | | | | | | | | | | | | | | | | | | | | | | | | | | | | | | | | | | | | | | | | | | | | | | | | | | | | | | | | | | | | | | | | | | | | | | | | | | | | | | | | | | | | | | | | | | | |
| 8 | 2.0 | 2.7 | | | | | | | | | | | | | | | | | | | | | | | | | | | | | | | | | | | | | | | | | | | | | | | | | | | | | | | | | | | | | | | | | | | | | | | | | | | | | | | | | | | | | | | | | | | | | | | | | | | | | | | | | | | | | | | | | | | | | | | | | | | | | | | | | | | | | | | | | | | | | | | | | | | | | | | | | | | | | | | |
| 1/2 SS | | | | | | | | | | | | | | | | | | | | | | | | | | | | | | | | | | | | | | | | | | | | | | | | | | | | | | | | | | | | | | | | | | | | | | | | | | | | | | | | | | | | | | | | | | | | | | | | | | | | | | | | | | | | | | | | | | | | | | | | | | | | | | | | | | | | | | | | | | | | | | | | | | | | | | | | | | | | | | | | | |
| 2 | 4 | 6 | 8 | 10 | | | | | | | | | | | | | | | | | | | | | | | | | | | | | | | | | | | | | | | | | | | | | | | | | | | | | | | | | | | | | | | | | | | | | | | | | | | | | | | | | | | | | | | | | | | | | | | | | | | | | | | | | | | | | | | | | | | | | | | | | | | | | | | | | | | | | | | | | | | | | | | | | | | | | | | | | | | | | |
| 0.3 | 0.5 | 0.8 | 1.1 | | | | | | | | | | | | | | | | | | | | | | | | | | | | | | | | | | | | | | | | | | | | | | | | | | | | | | | | | | | | | | | | | | | | | | | | | | | | | | | | | | | | | | | | | | | | | | | | | | | | | | | | | | | | | | | | | | | | | | | | | | | | | | | | | | | | | | | | | | | | | | | | | | | | | | | | | | | | | | |
| 3 | 0.9 | 1.4 | | | | | | | | | | | | | | | | | | | | | | | | | | | | | | | | | | | | | | | | | | | | | | | | | | | | | | | | | | | | | | | | | | | | | | | | | | | | | | | | | | | | | | | | | | | | | | | | | | | | | | | | | | | | | | | | | | | | | | | | | | | | | | | | | | | | | | | | | | | | | | | | | | | | | | | | | | | | | | | |
| 5 | 1.6 | 2.3 | | | | | | | | | | | | | | | | | | | | | | | | | | | | | | | | | | | | | | | | | | | | | | | | | | | | | | | | | | | | | | | | | | | | | | | | | | | | | | | | | | | | | | | | | | | | | | | | | | | | | | | | | | | | | | | | | | | | | | | | | | | | | | | | | | | | | | | | | | | | | | | | | | | | | | | | | | | | | | | |
| 7 | 2.5 | 3.4 | | | | | | | | | | | | | | | | | | | | | | | | | | | | | | | | | | | | | | | | | | | | | | | | | | | | | | | | | | | | | | | | | | | | | | | | | | | | | | | | | | | | | | | | | | | | | | | | | | | | | | | | | | | | | | | | | | | | | | | | | | | | | | | | | | | | | | | | | | | | | | | | | | | | | | | | | | | | | | | |
| 1/2 SS | | | | | | | | | | | | | | | | | | | | | | | | | | | | | | | | | | | | | | | | | | | | | | | | | | | | | | | | | | | | | | | | | | | | | | | | | | | | | | | | | | | | | | | | | | | | | | | | | | | | | | | | | | | | | | | | | | | | | | | | | | | | | | | | | | | | | | | | | | | | | | | | | | | | | | | | | | | | | | | | | |
| 2 | 4 | 6 | 8 | 10 | | | | | | | | | | | | | | | | | | | | | | | | | | | | | | | | | | | | | | | | | | | | | | | | | | | | | | | | | | | | | | | | | | | | | | | | | | | | | | | | | | | | | | | | | | | | | | | | | | | | | | | | | | | | | | | | | | | | | | | | | | | | | | | | | | | | | | | | | | | | | | | | | | | | | | | | | | | | | |
| 0.1 | 0.2 | 0.5 | 0.8 | | | | | | | | | | | | | | | | | | | | | | | | | | | | | | | | | | | | | | | | | | | | | | | | | | | | | | | | | | | | | | | | | | | | | | | | | | | | | | | | | | | | | | | | | | | | | | | | | | | | | | | | | | | | | | | | | | | | | | | | | | | | | | | | | | | | | | | | | | | | | | | | | | | | | | | | | | | | | | |
| BACK (GROUP 2) 2 - 52 | REVERSE (GROUP 5) 63 | | | | | | | | | | | | | | | | | | | | | | | | | | | | | | | | | | | | | | | | | | | | | | | | | | | | | | | | | | | | | | | | | | | | | | | | | | | | | | | | | | | | | | | | | | | | | | | | | | | | | | | | | | | | | | | | | | | | | | | | | | | | | | | | | | | | | | | | | | | | | | | | | | | | | | | | | | | | | | | | |
| <p>A. SOMERSAULTS</p> <table border="1"> <tr><td colspan="2">1/2 SS</td></tr> <tr><td>2</td><td>4</td><td>6</td><td>8</td><td>10</td></tr> <tr><td>2.3</td><td>2.6</td><td>3.4</td><td>4.7</td><td></td></tr> </table> <p>B. APPROACH</p> <table border="1"> <tr><td colspan="2">1/2 SS</td></tr> <tr><td>2</td><td>4</td><td>6</td><td>8</td><td>10</td></tr> <tr><td>0.2</td><td>0.3</td><td>0.5</td><td>0.7</td><td></td></tr> </table> <p>C. TWISTS BARANI ENTRY</p> <table border="1"> <tr><td colspan="2">1/2 SS</td></tr> <tr><td>1</td><td>3</td><td>5</td><td>7</td><td>9</td></tr> <tr><td>0.1</td><td>0.2</td><td>0.3</td><td>0.4</td><td></td></tr> <tr><td>4</td><td>0.6</td><td>0.9</td><td></td><td></td></tr> <tr><td>6</td><td>1.2</td><td>1.7</td><td></td><td></td></tr> <tr><td>8</td><td>2.0</td><td>2.7</td><td></td><td></td></tr> </table> <p>D. TWISTS BLIND ENTRY</p> <table border="1"> <tr><td colspan="2">1/2 SS</td></tr> <tr><td>2</td><td>4</td><td>6</td><td>8</td><td>10</td></tr> <tr><td>0.3</td><td>0.5</td><td>0.8</td><td>1.1</td><td></td></tr> <tr><td>3</td><td>0.9</td><td>1.4</td><td></td><td></td></tr> <tr><td>5</td><td>1.6</td><td>2.3</td><td></td><td></td></tr> <tr><td>7</td><td>2.5</td><td>3.4</td><td></td><td></td></tr> </table> <p>F. BACK ROTATION CONTROL ENTRY</p> <table border="1"> <tr><td colspan="2">1/2 SS</td></tr> <tr><td>1</td><td>3</td><td>5</td><td>7</td><td>9</td></tr> <tr><td>0.2</td><td>0.4</td><td>0.6</td><td>0.8</td><td></td></tr> </table> | 1/2 SS | | 2 | 4 | 6 | 8 | 10 | 2.3 | 2.6 | 3.4 | 4.7 | | 1/2 SS | | 2 | 4 | 6 | 8 | 10 | 0.2 | 0.3 | 0.5 | 0.7 | | 1/2 SS | | 1 | 3 | 5 | 7 | 9 | 0.1 | 0.2 | 0.3 | 0.4 | | 4 | 0.6 | 0.9 | | | 6 | 1.2 | 1.7 | | | 8 | 2.0 | 2.7 | | | 1/2 SS | | 2 | 4 | 6 | 8 | 10 | 0.3 | 0.5 | 0.8 | 1.1 | | 3 | 0.9 | 1.4 | | | 5 | 1.6 | 2.3 | | | 7 | 2.5 | 3.4 | | | 1/2 SS | | 1 | 3 | 5 | 7 | 9 | 0.2 | 0.4 | 0.6 | 0.8 | | <p>A1. SOMERSAULTS</p> <table border="1"> <tr><td colspan="2">1/2 SS</td></tr> <tr><td>1</td><td>3</td><td>5</td><td>7</td><td>9</td></tr> <tr><td>2.3</td><td>2.6</td><td>3.4</td><td>4.7</td><td></td></tr> </table> <p>B1. APPROACH</p> <table border="1"> <tr><td colspan="2">1/2 SS</td></tr> <tr><td>1</td><td>3</td><td>5</td><td>7</td><td>9</td></tr> <tr><td>0.1</td><td>0.3</td><td>0.5</td><td>0.8</td><td></td></tr> </table> <p>F1. BACK ROTATION CONTROL ENTRY</p> <table border="1"> <tr><td colspan="2">1/2 SS</td></tr> <tr><td>1</td><td>3</td><td>5</td><td>7</td><td>9</td></tr> <tr><td>0.2</td><td>0.4</td><td>0.6</td><td>0.8</td><td></td></tr> </table> | 1/2 SS | | 1 | 3 | 5 | 7 | 9 | 2.3 | 2.6 | 3.4 | 4.7 | | 1/2 SS | | 1 | 3 | 5 | 7 | 9 | 0.1 | 0.3 | 0.5 | 0.8 | | 1/2 SS | | 1 | 3 | 5 | 7 | 9 | 0.2 | 0.4 | 0.6 | 0.8 | | | | | | | | | | | | | | | | | | | | | | | | | | | | | | | | | | | |
| 1/2 SS | | | | | | | | | | | | | | | | | | | | | | | | | | | | | | | | | | | | | | | | | | | | | | | | | | | | | | | | | | | | | | | | | | | | | | | | | | | | | | | | | | | | | | | | | | | | | | | | | | | | | | | | | | | | | | | | | | | | | | | | | | | | | | | | | | | | | | | | | | | | | | | | | | | | | | | | | | | | | | | | | |
| 2 | 4 | 6 | 8 | 10 | | | | | | | | | | | | | | | | | | | | | | | | | | | | | | | | | | | | | | | | | | | | | | | | | | | | | | | | | | | | | | | | | | | | | | | | | | | | | | | | | | | | | | | | | | | | | | | | | | | | | | | | | | | | | | | | | | | | | | | | | | | | | | | | | | | | | | | | | | | | | | | | | | | | | | | | | | | | | |
| 2.3 | 2.6 | 3.4 | 4.7 | | | | | | | | | | | | | | | | | | | | | | | | | | | | | | | | | | | | | | | | | | | | | | | | | | | | | | | | | | | | | | | | | | | | | | | | | | | | | | | | | | | | | | | | | | | | | | | | | | | | | | | | | | | | | | | | | | | | | | | | | | | | | | | | | | | | | | | | | | | | | | | | | | | | | | | | | | | | | | |
| 1/2 SS | | | | | | | | | | | | | | | | | | | | | | | | | | | | | | | | | | | | | | | | | | | | | | | | | | | | | | | | | | | | | | | | | | | | | | | | | | | | | | | | | | | | | | | | | | | | | | | | | | | | | | | | | | | | | | | | | | | | | | | | | | | | | | | | | | | | | | | | | | | | | | | | | | | | | | | | | | | | | | | | | |
| 2 | 4 | 6 | 8 | 10 | | | | | | | | | | | | | | | | | | | | | | | | | | | | | | | | | | | | | | | | | | | | | | | | | | | | | | | | | | | | | | | | | | | | | | | | | | | | | | | | | | | | | | | | | | | | | | | | | | | | | | | | | | | | | | | | | | | | | | | | | | | | | | | | | | | | | | | | | | | | | | | | | | | | | | | | | | | | | |
| 0.2 | 0.3 | 0.5 | 0.7 | | | | | | | | | | | | | | | | | | | | | | | | | | | | | | | | | | | | | | | | | | | | | | | | | | | | | | | | | | | | | | | | | | | | | | | | | | | | | | | | | | | | | | | | | | | | | | | | | | | | | | | | | | | | | | | | | | | | | | | | | | | | | | | | | | | | | | | | | | | | | | | | | | | | | | | | | | | | | | |
| 1/2 SS | | | | | | | | | | | | | | | | | | | | | | | | | | | | | | | | | | | | | | | | | | | | | | | | | | | | | | | | | | | | | | | | | | | | | | | | | | | | | | | | | | | | | | | | | | | | | | | | | | | | | | | | | | | | | | | | | | | | | | | | | | | | | | | | | | | | | | | | | | | | | | | | | | | | | | | | | | | | | | | | | |
| 1 | 3 | 5 | 7 | 9 | | | | | | | | | | | | | | | | | | | | | | | | | | | | | | | | | | | | | | | | | | | | | | | | | | | | | | | | | | | | | | | | | | | | | | | | | | | | | | | | | | | | | | | | | | | | | | | | | | | | | | | | | | | | | | | | | | | | | | | | | | | | | | | | | | | | | | | | | | | | | | | | | | | | | | | | | | | | | |
| 0.1 | 0.2 | 0.3 | 0.4 | | | | | | | | | | | | | | | | | | | | | | | | | | | | | | | | | | | | | | | | | | | | | | | | | | | | | | | | | | | | | | | | | | | | | | | | | | | | | | | | | | | | | | | | | | | | | | | | | | | | | | | | | | | | | | | | | | | | | | | | | | | | | | | | | | | | | | | | | | | | | | | | | | | | | | | | | | | | | | |
| 4 | 0.6 | 0.9 | | | | | | | | | | | | | | | | | | | | | | | | | | | | | | | | | | | | | | | | | | | | | | | | | | | | | | | | | | | | | | | | | | | | | | | | | | | | | | | | | | | | | | | | | | | | | | | | | | | | | | | | | | | | | | | | | | | | | | | | | | | | | | | | | | | | | | | | | | | | | | | | | | | | | | | | | | | | | | | |
| 6 | 1.2 | 1.7 | | | | | | | | | | | | | | | | | | | | | | | | | | | | | | | | | | | | | | | | | | | | | | | | | | | | | | | | | | | | | | | | | | | | | | | | | | | | | | | | | | | | | | | | | | | | | | | | | | | | | | | | | | | | | | | | | | | | | | | | | | | | | | | | | | | | | | | | | | | | | | | | | | | | | | | | | | | | | | | |
| 8 | 2.0 | 2.7 | | | | | | | | | | | | | | | | | | | | | | | | | | | | | | | | | | | | | | | | | | | | | | | | | | | | | | | | | | | | | | | | | | | | | | | | | | | | | | | | | | | | | | | | | | | | | | | | | | | | | | | | | | | | | | | | | | | | | | | | | | | | | | | | | | | | | | | | | | | | | | | | | | | | | | | | | | | | | | | |
| 1/2 SS | | | | | | | | | | | | | | | | | | | | | | | | | | | | | | | | | | | | | | | | | | | | | | | | | | | | | | | | | | | | | | | | | | | | | | | | | | | | | | | | | | | | | | | | | | | | | | | | | | | | | | | | | | | | | | | | | | | | | | | | | | | | | | | | | | | | | | | | | | | | | | | | | | | | | | | | | | | | | | | | | |
| 2 | 4 | 6 | 8 | 10 | | | | | | | | | | | | | | | | | | | | | | | | | | | | | | | | | | | | | | | | | | | | | | | | | | | | | | | | | | | | | | | | | | | | | | | | | | | | | | | | | | | | | | | | | | | | | | | | | | | | | | | | | | | | | | | | | | | | | | | | | | | | | | | | | | | | | | | | | | | | | | | | | | | | | | | | | | | | | |
| 0.3 | 0.5 | 0.8 | 1.1 | | | | | | | | | | | | | | | | | | | | | | | | | | | | | | | | | | | | | | | | | | | | | | | | | | | | | | | | | | | | | | | | | | | | | | | | | | | | | | | | | | | | | | | | | | | | | | | | | | | | | | | | | | | | | | | | | | | | | | | | | | | | | | | | | | | | | | | | | | | | | | | | | | | | | | | | | | | | | | |
| 3 | 0.9 | 1.4 | | | | | | | | | | | | | | | | | | | | | | | | | | | | | | | | | | | | | | | | | | | | | | | | | | | | | | | | | | | | | | | | | | | | | | | | | | | | | | | | | | | | | | | | | | | | | | | | | | | | | | | | | | | | | | | | | | | | | | | | | | | | | | | | | | | | | | | | | | | | | | | | | | | | | | | | | | | | | | | |
| 5 | 1.6 | 2.3 | | | | | | | | | | | | | | | | | | | | | | | | | | | | | | | | | | | | | | | | | | | | | | | | | | | | | | | | | | | | | | | | | | | | | | | | | | | | | | | | | | | | | | | | | | | | | | | | | | | | | | | | | | | | | | | | | | | | | | | | | | | | | | | | | | | | | | | | | | | | | | | | | | | | | | | | | | | | | | | |
| 7 | 2.5 | 3.4 | | | | | | | | | | | | | | | | | | | | | | | | | | | | | | | | | | | | | | | | | | | | | | | | | | | | | | | | | | | | | | | | | | | | | | | | | | | | | | | | | | | | | | | | | | | | | | | | | | | | | | | | | | | | | | | | | | | | | | | | | | | | | | | | | | | | | | | | | | | | | | | | | | | | | | | | | | | | | | | |
| 1/2 SS | | | | | | | | | | | | | | | | | | | | | | | | | | | | | | | | | | | | | | | | | | | | | | | | | | | | | | | | | | | | | | | | | | | | | | | | | | | | | | | | | | | | | | | | | | | | | | | | | | | | | | | | | | | | | | | | | | | | | | | | | | | | | | | | | | | | | | | | | | | | | | | | | | | | | | | | | | | | | | | | | |
| 1 | 3 | 5 | 7 | 9 | | | | | | | | | | | | | | | | | | | | | | | | | | | | | | | | | | | | | | | | | | | | | | | | | | | | | | | | | | | | | | | | | | | | | | | | | | | | | | | | | | | | | | | | | | | | | | | | | | | | | | | | | | | | | | | | | | | | | | | | | | | | | | | | | | | | | | | | | | | | | | | | | | | | | | | | | | | | | |
| 0.2 | 0.4 | 0.6 | 0.8 | | | | | | | | | | | | | | | | | | | | | | | | | | | | | | | | | | | | | | | | | | | | | | | | | | | | | | | | | | | | | | | | | | | | | | | | | | | | | | | | | | | | | | | | | | | | | | | | | | | | | | | | | | | | | | | | | | | | | | | | | | | | | | | | | | | | | | | | | | | | | | | | | | | | | | | | | | | | | | |
| 1/2 SS | | | | | | | | | | | | | | | | | | | | | | | | | | | | | | | | | | | | | | | | | | | | | | | | | | | | | | | | | | | | | | | | | | | | | | | | | | | | | | | | | | | | | | | | | | | | | | | | | | | | | | | | | | | | | | | | | | | | | | | | | | | | | | | | | | | | | | | | | | | | | | | | | | | | | | | | | | | | | | | | | |
| 1 | 3 | 5 | 7 | 9 | | | | | | | | | | | | | | | | | | | | | | | | | | | | | | | | | | | | | | | | | | | | | | | | | | | | | | | | | | | | | | | | | | | | | | | | | | | | | | | | | | | | | | | | | | | | | | | | | | | | | | | | | | | | | | | | | | | | | | | | | | | | | | | | | | | | | | | | | | | | | | | | | | | | | | | | | | | | | |
| 2.3 | 2.6 | 3.4 | 4.7 | | | | | | | | | | | | | | | | | | | | | | | | | | | | | | | | | | | | | | | | | | | | | | | | | | | | | | | | | | | | | | | | | | | | | | | | | | | | | | | | | | | | | | | | | | | | | | | | | | | | | | | | | | | | | | | | | | | | | | | | | | | | | | | | | | | | | | | | | | | | | | | | | | | | | | | | | | | | | | |
| 1/2 SS | | | | | | | | | | | | | | | | | | | | | | | | | | | | | | | | | | | | | | | | | | | | | | | | | | | | | | | | | | | | | | | | | | | | | | | | | | | | | | | | | | | | | | | | | | | | | | | | | | | | | | | | | | | | | | | | | | | | | | | | | | | | | | | | | | | | | | | | | | | | | | | | | | | | | | | | | | | | | | | | | |
| 1 | 3 | 5 | 7 | 9 | | | | | | | | | | | | | | | | | | | | | | | | | | | | | | | | | | | | | | | | | | | | | | | | | | | | | | | | | | | | | | | | | | | | | | | | | | | | | | | | | | | | | | | | | | | | | | | | | | | | | | | | | | | | | | | | | | | | | | | | | | | | | | | | | | | | | | | | | | | | | | | | | | | | | | | | | | | | | |
| 0.1 | 0.3 | 0.5 | 0.8 | | | | | | | | | | | | | | | | | | | | | | | | | | | | | | | | | | | | | | | | | | | | | | | | | | | | | | | | | | | | | | | | | | | | | | | | | | | | | | | | | | | | | | | | | | | | | | | | | | | | | | | | | | | | | | | | | | | | | | | | | | | | | | | | | | | | | | | | | | | | | | | | | | | | | | | | | | | | | | |
| 1/2 SS | | | | | | | | | | | | | | | | | | | | | | | | | | | | | | | | | | | | | | | | | | | | | | | | | | | | | | | | | | | | | | | | | | | | | | | | | | | | | | | | | | | | | | | | | | | | | | | | | | | | | | | | | | | | | | | | | | | | | | | | | | | | | | | | | | | | | | | | | | | | | | | | | | | | | | | | | | | | | | | | | |
| 1 | 3 | 5 | 7 | 9 | | | | | | | | | | | | | | | | | | | | | | | | | | | | | | | | | | | | | | | | | | | | | | | | | | | | | | | | | | | | | | | | | | | | | | | | | | | | | | | | | | | | | | | | | | | | | | | | | | | | | | | | | | | | | | | | | | | | | | | | | | | | | | | | | | | | | | | | | | | | | | | | | | | | | | | | | | | | | |
| 0.2 | 0.4 | 0.6 | 0.8 | | | | | | | | | | | | | | | | | | | | | | | | | | | | | | | | | | | | | | | | | | | | | | | | | | | | | | | | | | | | | | | | | | | | | | | | | | | | | | | | | | | | | | | | | | | | | | | | | | | | | | | | | | | | | | | | | | | | | | | | | | | | | | | | | | | | | | | | | | | | | | | | | | | | | | | | | | | | | | |

HIGH DIVING: 15 METERS

| STANDING DIVES A+B+C+D+E+F+DD | ARMSTAND DIVES A1+B1+C1+D1+E1+F1+DD | | | | | | | | | | | | | | | | | | | | | | | | | | | | | | | | | | | | | | | | | | | | | | | | | | | | | | | | | | | | | | | | | | | | | | | | | | | | | | | | | | | | | | | | | | | | | | | | | | | | | | | | | | | | | | | | | | | | | | | | | | | | | | | | | | | | | | | | | | | | | | | | | | | | | | | | | | | | | | | | | | | | | | | | | | | | | | | | | | | | | | | | | | | | | | | | | | | | | | | | | | | | | | | | | | | | | | | | | | | | | | | | | | | | | | | | | | | | | | | | | | | | | | | | | | | | | | | | | | | | | | | | | | | | | | | | | | | | | | | | | | | | | | | | | | | | | | | | | | | | | | | | | | | | | | | | | | | | | | | | | | | | | | | | | | | | | | | | | | | | | | | | | | | | | | | | | | | | | | | | | | | | | | | | | | | | | | | | | | | | | | | | | | | | | | | | | | | | | | | | | | | | | | | | | | | | | | | | | | | | | | | | | | | | | | | | | | | | | | | | | | | | | | | | | | | | | | | | | | | | | | | | | | | | | | | | | | | | | | | | | | | | | | | | | | | | | | | | | | | | | | | | | | | | | | | | | | | | | | | | | | | | | | | | | | | | | | | | | | | | | | | | | | | | | | | | | | | | | | | | | | | | | | | | | | | | | | | | | | | | | | | | | | | | | | | | | | | | | | | | | | | | | | | |
|--|--|-----|-----|-----|---|---|----|-----|-----|-----|-----|-----|--------|--|---|---|---|---|----|-----|-----|-----|-----|-----|--------|--|---|---|---|---|----|---|-----|-----|-----|-----|---|-----|-----|-----|-----|---|-----|-----|-----|-----|---|-----|-----|-----|-----|---|-----|-----|-----|-----|--------|--|---|---|---|---|----|---|-----|-----|-----|-----|---|-----|-----|-----|-----|---|-----|-----|-----|-----|--------|--|---|---|---|---|----|-----|-----|-----|-----|-----|--------|--|---|---|---|---|----|-----|-----|-----|-----|-----|--------|--|---|---|---|---|----|-----|-----|-----|-----|-----|--------|--|---|---|---|---|----|---|-----|-----|-----|-----|---|-----|-----|-----|-----|---|-----|-----|-----|-----|---|-----|-----|-----|-----|----|-----|-----|-----|-----|--------|--|---|---|---|---|----|---|-----|-----|-----|-----|---|-----|-----|-----|-----|---|-----|-----|-----|-----|---|-----|-----|-----|-----|--------|--|---|---|---|---|----|-----|-----|-----|-----|-----|--|--------|--|---|---|---|---|----|-----|-----|-----|-----|-----|--------|--|---|---|---|---|----|-----|-----|-----|-----|-----|--------|--|---|---|---|---|----|---|-----|-----|-----|-----|---|-----|-----|-----|-----|---|-----|-----|-----|-----|---|-----|-----|-----|-----|--------|--|---|---|---|---|----|---|-----|-----|-----|-----|---|-----|-----|-----|-----|---|-----|-----|-----|-----|--------|--|---|---|---|---|----|-----|-----|-----|-----|-----|--------|--|---|---|---|---|----|-----|-----|-----|-----|-----|--------|--|---|---|---|---|----|-----|-----|-----|-----|-----|--------|--|---|---|---|---|----|---|-----|-----|-----|-----|---|-----|-----|-----|-----|---|-----|-----|-----|-----|---|-----|-----|-----|-----|----|-----|-----|-----|-----|--------|--|---|---|---|---|----|---|-----|-----|-----|-----|---|-----|-----|-----|-----|---|-----|-----|-----|-----|---|-----|-----|-----|-----|--------|--|---|---|---|---|----|-----|-----|-----|-----|-----|--|--------|--|---|---|---|---|---|-----|-----|-----|-----|-----|--------|--|---|---|---|---|---|-----|-----|-----|-----|-----|--------|--|---|---|---|---|---|---|-----|-----|-----|-----|---|-----|-----|-----|-----|---|-----|-----|-----|-----|---|-----|-----|-----|-----|--------|--|---|---|---|---|---|---|-----|-----|-----|-----|---|-----|-----|-----|-----|---|-----|-----|-----|-----|--------|--|---|---|---|---|---|-----|-----|-----|-----|-----|--------|--|---|---|---|---|---|-----|-----|-----|-----|-----|--------|--|---|---|---|---|---|-----|-----|-----|-----|-----|--------|--|---|---|---|---|---|---|-----|-----|-----|-----|---|-----|-----|-----|-----|---|-----|-----|-----|-----|---|-----|-----|-----|-----|----|-----|-----|-----|-----|--------|--|---|---|---|---|---|---|-----|-----|-----|-----|---|-----|-----|-----|-----|---|-----|-----|-----|-----|---|-----|-----|-----|-----|--------|--|---|---|---|---|---|-----|-----|-----|-----|-----|---|--------|--|---|---|---|---|---|-----|-----|-----|-----|-----|--------|--|---|---|---|---|---|-----|-----|-----|-----|-----|--------|--|---|---|---|---|---|-----|-----|-----|-----|-----|--------|--|---|---|---|---|---|-----|-----|-----|-----|-----|--------|--|---|---|---|---|---|-----|-----|-----|-----|-----|
| <p style="text-align: center;">FORWARD (GROUP 1)</p> <p style="text-align: center;">1 - 51</p> <p>A. SOMERSAULTS</p> <table border="1" style="width: 100%; text-align: center;"> <tr><td colspan="2">1/2 ss</td></tr> <tr><td>2</td><td>4</td><td>6</td><td>8</td><td>10</td></tr> <tr><td>2.4</td><td>2.7</td><td>3.2</td><td>4.2</td><td>5.7</td></tr> </table> <p>B. APPROACH</p> <table border="1" style="width: 100%; text-align: center;"> <tr><td colspan="2">1/2 ss</td></tr> <tr><td>2</td><td>4</td><td>6</td><td>8</td><td>10</td></tr> <tr><td>0.0</td><td>0.0</td><td>0.0</td><td>0.0</td><td>0.0</td></tr> </table> <p>C. TWISTS BARANI ENTRY</p> <table border="1" style="width: 100%; text-align: center;"> <tr><td colspan="2">1/2 ss</td></tr> <tr><td>2</td><td>4</td><td>6</td><td>8</td><td>10</td></tr> <tr><td>1</td><td>0.0</td><td>0.2</td><td>0.4</td><td>0.6</td></tr> <tr><td>3</td><td>0.5</td><td>0.9</td><td>1.4</td><td>2.0</td></tr> <tr><td>5</td><td>1.0</td><td>1.5</td><td>2.0</td><td>2.5</td></tr> <tr><td>7</td><td>1.4</td><td>1.9</td><td>2.4</td><td>2.9</td></tr> <tr><td>9</td><td>1.8</td><td>2.3</td><td>2.8</td><td>3.3</td></tr> </table> <p>D. TWISTS BLIND ENTRY</p> <table border="1" style="width: 100%; text-align: center;"> <tr><td colspan="2">1/2 ss</td></tr> <tr><td>2</td><td>4</td><td>6</td><td>8</td><td>10</td></tr> <tr><td>1</td><td>0.8</td><td>1.3</td><td>1.8</td><td>2.3</td></tr> <tr><td>4</td><td>1.3</td><td>1.8</td><td>2.3</td><td>2.8</td></tr> <tr><td>6</td><td>1.9</td><td>2.4</td><td>2.9</td><td>3.4</td></tr> </table> <p>E. BLIND ENTRY</p> <table border="1" style="width: 100%; text-align: center;"> <tr><td colspan="2">1/2 ss</td></tr> <tr><td>2</td><td>4</td><td>6</td><td>8</td><td>10</td></tr> <tr><td>0.2</td><td>0.5</td><td>0.8</td><td>1.2</td><td>1.6</td></tr> </table> <p style="text-align: center;">BACK (GROUP 2)</p> <p>A. SOMERSAULTS</p> <table border="1" style="width: 100%; text-align: center;"> <tr><td colspan="2">1/2 ss</td></tr> <tr><td>2</td><td>4</td><td>6</td><td>8</td><td>10</td></tr> <tr><td>2.4</td><td>2.7</td><td>3.2</td><td>4.2</td><td>5.7</td></tr> </table> <p>B. APPROACH</p> <table border="1" style="width: 100%; text-align: center;"> <tr><td colspan="2">1/2 ss</td></tr> <tr><td>2</td><td>4</td><td>6</td><td>8</td><td>10</td></tr> <tr><td>0.2</td><td>0.3</td><td>0.5</td><td>0.7</td><td>0.9</td></tr> </table> <p>C. TWISTS BARANI ENTRY</p> <table border="1" style="width: 100%; text-align: center;"> <tr><td colspan="2">1/2 ss</td></tr> <tr><td>2</td><td>4</td><td>6</td><td>8</td><td>10</td></tr> <tr><td>2</td><td>0.1</td><td>0.2</td><td>0.3</td><td>0.4</td></tr> <tr><td>4</td><td>0.5</td><td>0.8</td><td>1.1</td><td>1.4</td></tr> <tr><td>6</td><td>0.9</td><td>1.4</td><td>1.9</td><td>2.4</td></tr> <tr><td>8</td><td>1.3</td><td>1.8</td><td>2.3</td><td>2.8</td></tr> <tr><td>10</td><td>1.7</td><td>2.2</td><td>2.7</td><td>3.2</td></tr> </table> <p>D. TWISTS BLIND ENTRY</p> <table border="1" style="width: 100%; text-align: center;"> <tr><td colspan="2">1/2 ss</td></tr> <tr><td>2</td><td>4</td><td>6</td><td>8</td><td>10</td></tr> <tr><td>1</td><td>0.3</td><td>0.5</td><td>0.8</td><td>1.1</td></tr> <tr><td>3</td><td>0.8</td><td>1.3</td><td>1.8</td><td>2.3</td></tr> <tr><td>5</td><td>1.3</td><td>1.8</td><td>2.3</td><td>2.8</td></tr> <tr><td>7</td><td>1.7</td><td>2.2</td><td>2.7</td><td>3.2</td></tr> </table> <p>F. BACK ROTATION CONTROL ENTRY</p> <table border="1" style="width: 100%; text-align: center;"> <tr><td colspan="2">1/2 ss</td></tr> <tr><td>2</td><td>4</td><td>6</td><td>8</td><td>10</td></tr> <tr><td>0.1</td><td>0.2</td><td>0.5</td><td>0.8</td><td>1.0</td></tr> </table> | 1/2 ss | | 2 | 4 | 6 | 8 | 10 | 2.4 | 2.7 | 3.2 | 4.2 | 5.7 | 1/2 ss | | 2 | 4 | 6 | 8 | 10 | 0.0 | 0.0 | 0.0 | 0.0 | 0.0 | 1/2 ss | | 2 | 4 | 6 | 8 | 10 | 1 | 0.0 | 0.2 | 0.4 | 0.6 | 3 | 0.5 | 0.9 | 1.4 | 2.0 | 5 | 1.0 | 1.5 | 2.0 | 2.5 | 7 | 1.4 | 1.9 | 2.4 | 2.9 | 9 | 1.8 | 2.3 | 2.8 | 3.3 | 1/2 ss | | 2 | 4 | 6 | 8 | 10 | 1 | 0.8 | 1.3 | 1.8 | 2.3 | 4 | 1.3 | 1.8 | 2.3 | 2.8 | 6 | 1.9 | 2.4 | 2.9 | 3.4 | 1/2 ss | | 2 | 4 | 6 | 8 | 10 | 0.2 | 0.5 | 0.8 | 1.2 | 1.6 | 1/2 ss | | 2 | 4 | 6 | 8 | 10 | 2.4 | 2.7 | 3.2 | 4.2 | 5.7 | 1/2 ss | | 2 | 4 | 6 | 8 | 10 | 0.2 | 0.3 | 0.5 | 0.7 | 0.9 | 1/2 ss | | 2 | 4 | 6 | 8 | 10 | 2 | 0.1 | 0.2 | 0.3 | 0.4 | 4 | 0.5 | 0.8 | 1.1 | 1.4 | 6 | 0.9 | 1.4 | 1.9 | 2.4 | 8 | 1.3 | 1.8 | 2.3 | 2.8 | 10 | 1.7 | 2.2 | 2.7 | 3.2 | 1/2 ss | | 2 | 4 | 6 | 8 | 10 | 1 | 0.3 | 0.5 | 0.8 | 1.1 | 3 | 0.8 | 1.3 | 1.8 | 2.3 | 5 | 1.3 | 1.8 | 2.3 | 2.8 | 7 | 1.7 | 2.2 | 2.7 | 3.2 | 1/2 ss | | 2 | 4 | 6 | 8 | 10 | 0.1 | 0.2 | 0.5 | 0.8 | 1.0 | <p style="text-align: center;">INWARD (GROUP 4)</p> <p style="text-align: center;">4 - 54</p> <p>A. SOMERSAULTS</p> <table border="1" style="width: 100%; text-align: center;"> <tr><td colspan="2">1/2 ss</td></tr> <tr><td>2</td><td>4</td><td>6</td><td>8</td><td>10</td></tr> <tr><td>2.4</td><td>2.7</td><td>3.2</td><td>4.2</td><td>5.7</td></tr> </table> <p>B. APPROACH</p> <table border="1" style="width: 100%; text-align: center;"> <tr><td colspan="2">1/2 ss</td></tr> <tr><td>2</td><td>4</td><td>6</td><td>8</td><td>10</td></tr> <tr><td>0.2</td><td>0.4</td><td>0.6</td><td>0.8</td><td>1.0</td></tr> </table> <p>C. TWISTS BARANI ENTRY</p> <table border="1" style="width: 100%; text-align: center;"> <tr><td colspan="2">1/2 ss</td></tr> <tr><td>2</td><td>4</td><td>6</td><td>8</td><td>10</td></tr> <tr><td>1</td><td>0.1</td><td>0.2</td><td>0.4</td><td>0.7</td></tr> <tr><td>3</td><td>0.6</td><td>1.0</td><td>1.5</td><td>2.0</td></tr> <tr><td>5</td><td>1.1</td><td>1.7</td><td>2.2</td><td>2.7</td></tr> <tr><td>7</td><td>1.6</td><td>2.2</td><td>2.8</td><td>3.4</td></tr> </table> <p>D. TWISTS BLIND ENTRY</p> <table border="1" style="width: 100%; text-align: center;"> <tr><td colspan="2">1/2 ss</td></tr> <tr><td>2</td><td>4</td><td>6</td><td>8</td><td>10</td></tr> <tr><td>1</td><td>1.0</td><td>1.5</td><td>2.0</td><td>2.5</td></tr> <tr><td>4</td><td>1.6</td><td>2.3</td><td>3.0</td><td>3.7</td></tr> <tr><td>6</td><td>2.3</td><td>3.0</td><td>3.7</td><td>4.4</td></tr> </table> <p>E. BLIND ENTRY</p> <table border="1" style="width: 100%; text-align: center;"> <tr><td colspan="2">1/2 ss</td></tr> <tr><td>2</td><td>4</td><td>6</td><td>8</td><td>10</td></tr> <tr><td>0.4</td><td>0.6</td><td>0.9</td><td>1.4</td><td>2.0</td></tr> </table> <p style="text-align: center;">REVERSE (GROUP 3)</p> <p>A. SOMERSAULTS</p> <table border="1" style="width: 100%; text-align: center;"> <tr><td colspan="2">1/2 ss</td></tr> <tr><td>2</td><td>4</td><td>6</td><td>8</td><td>10</td></tr> <tr><td>2.4</td><td>2.7</td><td>3.2</td><td>4.2</td><td>5.7</td></tr> </table> <p>B. APPROACH</p> <table border="1" style="width: 100%; text-align: center;"> <tr><td colspan="2">1/2 ss</td></tr> <tr><td>2</td><td>4</td><td>6</td><td>8</td><td>10</td></tr> <tr><td>0.2</td><td>0.3</td><td>0.5</td><td>0.7</td><td>0.9</td></tr> </table> <p>C. TWISTS BARANI ENTRY</p> <table border="1" style="width: 100%; text-align: center;"> <tr><td colspan="2">1/2 ss</td></tr> <tr><td>2</td><td>4</td><td>6</td><td>8</td><td>10</td></tr> <tr><td>2</td><td>0.2</td><td>0.3</td><td>0.4</td><td>0.6</td></tr> <tr><td>4</td><td>0.7</td><td>1.1</td><td>1.6</td><td>2.1</td></tr> <tr><td>6</td><td>1.2</td><td>1.7</td><td>2.2</td><td>2.7</td></tr> <tr><td>8</td><td>1.7</td><td>2.2</td><td>2.7</td><td>3.2</td></tr> <tr><td>10</td><td>2.2</td><td>2.7</td><td>3.2</td><td>3.7</td></tr> </table> <p>D. TWISTS BLIND ENTRY</p> <table border="1" style="width: 100%; text-align: center;"> <tr><td colspan="2">1/2 ss</td></tr> <tr><td>2</td><td>4</td><td>6</td><td>8</td><td>10</td></tr> <tr><td>1</td><td>0.4</td><td>0.6</td><td>0.9</td><td>1.3</td></tr> <tr><td>3</td><td>1.0</td><td>1.5</td><td>2.0</td><td>2.5</td></tr> <tr><td>5</td><td>1.6</td><td>2.1</td><td>2.6</td><td>3.1</td></tr> <tr><td>7</td><td>2.2</td><td>2.7</td><td>3.2</td><td>3.7</td></tr> </table> <p>F. BACK ROTATION CONTROL ENTRY</p> <table border="1" style="width: 100%; text-align: center;"> <tr><td colspan="2">1/2 ss</td></tr> <tr><td>2</td><td>4</td><td>6</td><td>8</td><td>10</td></tr> <tr><td>0.1</td><td>0.3</td><td>0.6</td><td>1.0</td><td>1.4</td></tr> </table> | 1/2 ss | | 2 | 4 | 6 | 8 | 10 | 2.4 | 2.7 | 3.2 | 4.2 | 5.7 | 1/2 ss | | 2 | 4 | 6 | 8 | 10 | 0.2 | 0.4 | 0.6 | 0.8 | 1.0 | 1/2 ss | | 2 | 4 | 6 | 8 | 10 | 1 | 0.1 | 0.2 | 0.4 | 0.7 | 3 | 0.6 | 1.0 | 1.5 | 2.0 | 5 | 1.1 | 1.7 | 2.2 | 2.7 | 7 | 1.6 | 2.2 | 2.8 | 3.4 | 1/2 ss | | 2 | 4 | 6 | 8 | 10 | 1 | 1.0 | 1.5 | 2.0 | 2.5 | 4 | 1.6 | 2.3 | 3.0 | 3.7 | 6 | 2.3 | 3.0 | 3.7 | 4.4 | 1/2 ss | | 2 | 4 | 6 | 8 | 10 | 0.4 | 0.6 | 0.9 | 1.4 | 2.0 | 1/2 ss | | 2 | 4 | 6 | 8 | 10 | 2.4 | 2.7 | 3.2 | 4.2 | 5.7 | 1/2 ss | | 2 | 4 | 6 | 8 | 10 | 0.2 | 0.3 | 0.5 | 0.7 | 0.9 | 1/2 ss | | 2 | 4 | 6 | 8 | 10 | 2 | 0.2 | 0.3 | 0.4 | 0.6 | 4 | 0.7 | 1.1 | 1.6 | 2.1 | 6 | 1.2 | 1.7 | 2.2 | 2.7 | 8 | 1.7 | 2.2 | 2.7 | 3.2 | 10 | 2.2 | 2.7 | 3.2 | 3.7 | 1/2 ss | | 2 | 4 | 6 | 8 | 10 | 1 | 0.4 | 0.6 | 0.9 | 1.3 | 3 | 1.0 | 1.5 | 2.0 | 2.5 | 5 | 1.6 | 2.1 | 2.6 | 3.1 | 7 | 2.2 | 2.7 | 3.2 | 3.7 | 1/2 ss | | 2 | 4 | 6 | 8 | 10 | 0.1 | 0.3 | 0.6 | 1.0 | 1.4 | <p style="text-align: center;">FORWARD (GROUP 5)</p> <p style="text-align: center;">61</p> <p>A1. SOMERSAULTS</p> <table border="1" style="width: 100%; text-align: center;"> <tr><td colspan="2">1/2 ss</td></tr> <tr><td>1</td><td>3</td><td>5</td><td>7</td><td>9</td></tr> <tr><td>2.4</td><td>2.7</td><td>3.2</td><td>4.2</td><td>5.7</td></tr> </table> <p>B1. APPROACH</p> <table border="1" style="width: 100%; text-align: center;"> <tr><td colspan="2">1/2 ss</td></tr> <tr><td>1</td><td>3</td><td>5</td><td>7</td><td>9</td></tr> <tr><td>0.0</td><td>0.1</td><td>0.3</td><td>0.5</td><td>0.7</td></tr> </table> <p>C1. TWISTS BARANI ENTRY</p> <table border="1" style="width: 100%; text-align: center;"> <tr><td colspan="2">1/2 ss</td></tr> <tr><td>1</td><td>3</td><td>5</td><td>7</td><td>9</td></tr> <tr><td>1</td><td>0.0</td><td>0.1</td><td>0.3</td><td>0.5</td></tr> <tr><td>3</td><td>0.6</td><td>0.9</td><td>1.4</td><td>2.0</td></tr> <tr><td>5</td><td>1.2</td><td>1.7</td><td>2.2</td><td>2.7</td></tr> <tr><td>7</td><td>1.8</td><td>2.3</td><td>2.8</td><td>3.3</td></tr> </table> <p>D1. TWISTS BLIND ENTRY</p> <table border="1" style="width: 100%; text-align: center;"> <tr><td colspan="2">1/2 ss</td></tr> <tr><td>1</td><td>3</td><td>5</td><td>7</td><td>9</td></tr> <tr><td>1</td><td>0.9</td><td>1.4</td><td>2.1</td><td>2.8</td></tr> <tr><td>4</td><td>1.6</td><td>2.3</td><td>3.0</td><td>3.7</td></tr> <tr><td>6</td><td>2.3</td><td>3.0</td><td>3.7</td><td>4.4</td></tr> </table> <p>E1. BLIND ENTRY</p> <table border="1" style="width: 100%; text-align: center;"> <tr><td colspan="2">1/2 ss</td></tr> <tr><td>1</td><td>3</td><td>5</td><td>7</td><td>9</td></tr> <tr><td>0.1</td><td>0.4</td><td>0.8</td><td>1.2</td><td>1.6</td></tr> </table> <p style="text-align: center;">BACK (GROUP 5)</p> <p>A1. SOMERSAULTS</p> <table border="1" style="width: 100%; text-align: center;"> <tr><td colspan="2">1/2 ss</td></tr> <tr><td>1</td><td>3</td><td>5</td><td>7</td><td>9</td></tr> <tr><td>2.4</td><td>2.7</td><td>3.2</td><td>4.2</td><td>5.7</td></tr> </table> <p>B1. APPROACH</p> <table border="1" style="width: 100%; text-align: center;"> <tr><td colspan="2">1/2 ss</td></tr> <tr><td>1</td><td>3</td><td>5</td><td>7</td><td>9</td></tr> <tr><td>0.0</td><td>0.0</td><td>0.3</td><td>0.5</td><td>0.7</td></tr> </table> <p>C1. TWISTS BARANI ENTRY</p> <table border="1" style="width: 100%; text-align: center;"> <tr><td colspan="2">1/2 ss</td></tr> <tr><td>1</td><td>3</td><td>5</td><td>7</td><td>9</td></tr> <tr><td>2</td><td>0.1</td><td>0.2</td><td>0.4</td><td>0.6</td></tr> <tr><td>4</td><td>0.5</td><td>0.9</td><td>1.4</td><td>2.0</td></tr> <tr><td>6</td><td>0.9</td><td>1.6</td><td>2.2</td><td>2.9</td></tr> <tr><td>8</td><td>1.4</td><td>2.1</td><td>2.8</td><td>3.5</td></tr> <tr><td>10</td><td>2.0</td><td>2.7</td><td>3.4</td><td>4.1</td></tr> </table> <p>D1. TWISTS BLIND ENTRY</p> <table border="1" style="width: 100%; text-align: center;"> <tr><td colspan="2">1/2 ss</td></tr> <tr><td>1</td><td>3</td><td>5</td><td>7</td><td>9</td></tr> <tr><td>1</td><td>0.3</td><td>0.5</td><td>0.9</td><td>1.3</td></tr> <tr><td>3</td><td>0.8</td><td>1.4</td><td>2.0</td><td>2.6</td></tr> <tr><td>5</td><td>1.3</td><td>2.0</td><td>2.7</td><td>3.4</td></tr> <tr><td>7</td><td>1.9</td><td>2.6</td><td>3.3</td><td>4.0</td></tr> </table> <p>F1. BACK ROTATION CONTROL ENTRY</p> <table border="1" style="width: 100%; text-align: center;"> <tr><td colspan="2">1/2 ss</td></tr> <tr><td>1</td><td>3</td><td>5</td><td>7</td><td>9</td></tr> <tr><td>0.2</td><td>0.4</td><td>0.7</td><td>1.0</td><td>1.5</td></tr> </table> | 1/2 ss | | 1 | 3 | 5 | 7 | 9 | 2.4 | 2.7 | 3.2 | 4.2 | 5.7 | 1/2 ss | | 1 | 3 | 5 | 7 | 9 | 0.0 | 0.1 | 0.3 | 0.5 | 0.7 | 1/2 ss | | 1 | 3 | 5 | 7 | 9 | 1 | 0.0 | 0.1 | 0.3 | 0.5 | 3 | 0.6 | 0.9 | 1.4 | 2.0 | 5 | 1.2 | 1.7 | 2.2 | 2.7 | 7 | 1.8 | 2.3 | 2.8 | 3.3 | 1/2 ss | | 1 | 3 | 5 | 7 | 9 | 1 | 0.9 | 1.4 | 2.1 | 2.8 | 4 | 1.6 | 2.3 | 3.0 | 3.7 | 6 | 2.3 | 3.0 | 3.7 | 4.4 | 1/2 ss | | 1 | 3 | 5 | 7 | 9 | 0.1 | 0.4 | 0.8 | 1.2 | 1.6 | 1/2 ss | | 1 | 3 | 5 | 7 | 9 | 2.4 | 2.7 | 3.2 | 4.2 | 5.7 | 1/2 ss | | 1 | 3 | 5 | 7 | 9 | 0.0 | 0.0 | 0.3 | 0.5 | 0.7 | 1/2 ss | | 1 | 3 | 5 | 7 | 9 | 2 | 0.1 | 0.2 | 0.4 | 0.6 | 4 | 0.5 | 0.9 | 1.4 | 2.0 | 6 | 0.9 | 1.6 | 2.2 | 2.9 | 8 | 1.4 | 2.1 | 2.8 | 3.5 | 10 | 2.0 | 2.7 | 3.4 | 4.1 | 1/2 ss | | 1 | 3 | 5 | 7 | 9 | 1 | 0.3 | 0.5 | 0.9 | 1.3 | 3 | 0.8 | 1.4 | 2.0 | 2.6 | 5 | 1.3 | 2.0 | 2.7 | 3.4 | 7 | 1.9 | 2.6 | 3.3 | 4.0 | 1/2 ss | | 1 | 3 | 5 | 7 | 9 | 0.2 | 0.4 | 0.7 | 1.0 | 1.5 | <p style="text-align: center;">REVERSE (GROUP 5)</p> <p style="text-align: center;">63</p> <p>A1. SOMERSAULTS</p> <table border="1" style="width: 100%; text-align: center;"> <tr><td colspan="2">1/2 ss</td></tr> <tr><td>1</td><td>3</td><td>5</td><td>7</td><td>9</td></tr> <tr><td>2.4</td><td>2.7</td><td>3.2</td><td>4.2</td><td>5.7</td></tr> </table> <p>B1. SOMERSAULTS</p> <table border="1" style="width: 100%; text-align: center;"> <tr><td colspan="2">1/2 ss</td></tr> <tr><td>1</td><td>3</td><td>5</td><td>7</td><td>9</td></tr> <tr><td>0.1</td><td>0.3</td><td>0.5</td><td>0.8</td><td>1.1</td></tr> </table> <p style="text-align: center;">REVERSE (GROUP 5)</p> <p style="text-align: center;">63</p> <p>A1. SOMERSAULTS</p> <table border="1" style="width: 100%; text-align: center;"> <tr><td colspan="2">1/2 ss</td></tr> <tr><td>1</td><td>3</td><td>5</td><td>7</td><td>9</td></tr> <tr><td>2.4</td><td>2.7</td><td>3.2</td><td>4.2</td><td>5.7</td></tr> </table> <p>B1. SOMERSAULTS</p> <table border="1" style="width: 100%; text-align: center;"> <tr><td colspan="2">1/2 ss</td></tr> <tr><td>1</td><td>3</td><td>5</td><td>7</td><td>9</td></tr> <tr><td>0.1</td><td>0.3</td><td>0.5</td><td>0.8</td><td>1.1</td></tr> </table> <p style="text-align: center;">REVERSE (GROUP 5)</p> <p style="text-align: center;">63</p> <p>F1. BACK ROTATION CONTROL ENTRY</p> <table border="1" style="width: 100%; text-align: center;"> <tr><td colspan="2">1/2 ss</td></tr> <tr><td>1</td><td>3</td><td>5</td><td>7</td><td>9</td></tr> <tr><td>0.2</td><td>0.4</td><td>0.6</td><td>0.8</td><td>1.0</td></tr> </table> | 1/2 ss | | 1 | 3 | 5 | 7 | 9 | 2.4 | 2.7 | 3.2 | 4.2 | 5.7 | 1/2 ss | | 1 | 3 | 5 | 7 | 9 | 0.1 | 0.3 | 0.5 | 0.8 | 1.1 | 1/2 ss | | 1 | 3 | 5 | 7 | 9 | 2.4 | 2.7 | 3.2 | 4.2 | 5.7 | 1/2 ss | | 1 | 3 | 5 | 7 | 9 | 0.1 | 0.3 | 0.5 | 0.8 | 1.1 | 1/2 ss | | 1 | 3 | 5 | 7 | 9 | 0.2 | 0.4 | 0.6 | 0.8 | 1.0 |
| 1/2 ss | | | | | | | | | | | | | | | | | | | | | | | | | | | | | | | | | | | | | | | | | | | | | | | | | | | | | | | | | | | | | | | | | | | | | | | | | | | | | | | | | | | | | | | | | | | | | | | | | | | | | | | | | | | | | | | | | | | | | | | | | | | | | | | | | | | | | | | | | | | | | | | | | | | | | | | | | | | | | | | | | | | | | | | | | | | | | | | | | | | | | | | | | | | | | | | | | | | | | | | | | | | | | | | | | | | | | | | | | | | | | | | | | | | | | | | | | | | | | | | | | | | | | | | | | | | | | | | | | | | | | | | | | | | | | | | | | | | | | | | | | | | | | | | | | | | | | | | | | | | | | | | | | | | | | | | | | | | | | | | | | | | | | | | | | | | | | | | | | | | | | | | | | | | | | | | | | | | | | | | | | | | | | | | | | | | | | | | | | | | | | | | | | | | | | | | | | | | | | | | | | | | | | | | | | | | | | | | | | | | | | | | | | | | | | | | | | | | | | | | | | | | | | | | | | | | | | | | | | | | | | | | | | | | | | | | | | | | | | | | | | | | | | | | | | | | | | | | | | | | | | | | | | | | | | | | | | | | | | | | | | | | | | | | | | | | | | | | | | | | | | | | | | | | | | | | | | | | | | | | | | | | | | | | | | | | | | | | | | | | | | | | | | | | | | | | | | | | | | | | | | | | | | | | | |
| 2 | 4 | 6 | 8 | 10 | | | | | | | | | | | | | | | | | | | | | | | | | | | | | | | | | | | | | | | | | | | | | | | | | | | | | | | | | | | | | | | | | | | | | | | | | | | | | | | | | | | | | | | | | | | | | | | | | | | | | | | | | | | | | | | | | | | | | | | | | | | | | | | | | | | | | | | | | | | | | | | | | | | | | | | | | | | | | | | | | | | | | | | | | | | | | | | | | | | | | | | | | | | | | | | | | | | | | | | | | | | | | | | | | | | | | | | | | | | | | | | | | | | | | | | | | | | | | | | | | | | | | | | | | | | | | | | | | | | | | | | | | | | | | | | | | | | | | | | | | | | | | | | | | | | | | | | | | | | | | | | | | | | | | | | | | | | | | | | | | | | | | | | | | | | | | | | | | | | | | | | | | | | | | | | | | | | | | | | | | | | | | | | | | | | | | | | | | | | | | | | | | | | | | | | | | | | | | | | | | | | | | | | | | | | | | | | | | | | | | | | | | | | | | | | | | | | | | | | | | | | | | | | | | | | | | | | | | | | | | | | | | | | | | | | | | | | | | | | | | | | | | | | | | | | | | | | | | | | | | | | | | | | | | | | | | | | | | | | | | | | | | | | | | | | | | | | | | | | | | | | | | | | | | | | | | | | | | | | | | | | | | | | | | | | | | | | | | | | | | | | | | | | | | | | | | | | | | | | | | | | | |
| 2.4 | 2.7 | 3.2 | 4.2 | 5.7 | | | | | | | | | | | | | | | | | | | | | | | | | | | | | | | | | | | | | | | | | | | | | | | | | | | | | | | | | | | | | | | | | | | | | | | | | | | | | | | | | | | | | | | | | | | | | | | | | | | | | | | | | | | | | | | | | | | | | | | | | | | | | | | | | | | | | | | | | | | | | | | | | | | | | | | | | | | | | | | | | | | | | | | | | | | | | | | | | | | | | | | | | | | | | | | | | | | | | | | | | | | | | | | | | | | | | | | | | | | | | | | | | | | | | | | | | | | | | | | | | | | | | | | | | | | | | | | | | | | | | | | | | | | | | | | | | | | | | | | | | | | | | | | | | | | | | | | | | | | | | | | | | | | | | | | | | | | | | | | | | | | | | | | | | | | | | | | | | | | | | | | | | | | | | | | | | | | | | | | | | | | | | | | | | | | | | | | | | | | | | | | | | | | | | | | | | | | | | | | | | | | | | | | | | | | | | | | | | | | | | | | | | | | | | | | | | | | | | | | | | | | | | | | | | | | | | | | | | | | | | | | | | | | | | | | | | | | | | | | | | | | | | | | | | | | | | | | | | | | | | | | | | | | | | | | | | | | | | | | | | | | | | | | | | | | | | | | | | | | | | | | | | | | | | | | | | | | | | | | | | | | | | | | | | | | | | | | | | | | | | | | | | | | | | | | | | | | | | | | | | | | | |
| 1/2 ss | | | | | | | | | | | | | | | | | | | | | | | | | | | | | | | | | | | | | | | | | | | | | | | | | | | | | | | | | | | | | | | | | | | | | | | | | | | | | | | | | | | | | | | | | | | | | | | | | | | | | | | | | | | | | | | | | | | | | | | | | | | | | | | | | | | | | | | | | | | | | | | | | | | | | | | | | | | | | | | | | | | | | | | | | | | | | | | | | | | | | | | | | | | | | | | | | | | | | | | | | | | | | | | | | | | | | | | | | | | | | | | | | | | | | | | | | | | | | | | | | | | | | | | | | | | | | | | | | | | | | | | | | | | | | | | | | | | | | | | | | | | | | | | | | | | | | | | | | | | | | | | | | | | | | | | | | | | | | | | | | | | | | | | | | | | | | | | | | | | | | | | | | | | | | | | | | | | | | | | | | | | | | | | | | | | | | | | | | | | | | | | | | | | | | | | | | | | | | | | | | | | | | | | | | | | | | | | | | | | | | | | | | | | | | | | | | | | | | | | | | | | | | | | | | | | | | | | | | | | | | | | | | | | | | | | | | | | | | | | | | | | | | | | | | | | | | | | | | | | | | | | | | | | | | | | | | | | | | | | | | | | | | | | | | | | | | | | | | | | | | | | | | | | | | | | | | | | | | | | | | | | | | | | | | | | | | | | | | | | | | | | | | | | | | | | | | | | | | | | | | | | | | | | | |
| 2 | 4 | 6 | 8 | 10 | | | | | | | | | | | | | | | | | | | | | | | | | | | | | | | | | | | | | | | | | | | | | | | | | | | | | | | | | | | | | | | | | | | | | | | | | | | | | | | | | | | | | | | | | | | | | | | | | | | | | | | | | | | | | | | | | | | | | | | | | | | | | | | | | | | | | | | | | | | | | | | | | | | | | | | | | | | | | | | | | | | | | | | | | | | | | | | | | | | | | | | | | | | | | | | | | | | | | | | | | | | | | | | | | | | | | | | | | | | | | | | | | | | | | | | | | | | | | | | | | | | | | | | | | | | | | | | | | | | | | | | | | | | | | | | | | | | | | | | | | | | | | | | | | | | | | | | | | | | | | | | | | | | | | | | | | | | | | | | | | | | | | | | | | | | | | | | | | | | | | | | | | | | | | | | | | | | | | | | | | | | | | | | | | | | | | | | | | | | | | | | | | | | | | | | | | | | | | | | | | | | | | | | | | | | | | | | | | | | | | | | | | | | | | | | | | | | | | | | | | | | | | | | | | | | | | | | | | | | | | | | | | | | | | | | | | | | | | | | | | | | | | | | | | | | | | | | | | | | | | | | | | | | | | | | | | | | | | | | | | | | | | | | | | | | | | | | | | | | | | | | | | | | | | | | | | | | | | | | | | | | | | | | | | | | | | | | | | | | | | | | | | | | | | | | | | | | | | | | | | | | | |
| 0.0 | 0.0 | 0.0 | 0.0 | 0.0 | | | | | | | | | | | | | | | | | | | | | | | | | | | | | | | | | | | | | | | | | | | | | | | | | | | | | | | | | | | | | | | | | | | | | | | | | | | | | | | | | | | | | | | | | | | | | | | | | | | | | | | | | | | | | | | | | | | | | | | | | | | | | | | | | | | | | | | | | | | | | | | | | | | | | | | | | | | | | | | | | | | | | | | | | | | | | | | | | | | | | | | | | | | | | | | | | | | | | | | | | | | | | | | | | | | | | | | | | | | | | | | | | | | | | | | | | | | | | | | | | | | | | | | | | | | | | | | | | | | | | | | | | | | | | | | | | | | | | | | | | | | | | | | | | | | | | | | | | | | | | | | | | | | | | | | | | | | | | | | | | | | | | | | | | | | | | | | | | | | | | | | | | | | | | | | | | | | | | | | | | | | | | | | | | | | | | | | | | | | | | | | | | | | | | | | | | | | | | | | | | | | | | | | | | | | | | | | | | | | | | | | | | | | | | | | | | | | | | | | | | | | | | | | | | | | | | | | | | | | | | | | | | | | | | | | | | | | | | | | | | | | | | | | | | | | | | | | | | | | | | | | | | | | | | | | | | | | | | | | | | | | | | | | | | | | | | | | | | | | | | | | | | | | | | | | | | | | | | | | | | | | | | | | | | | | | | | | | | | | | | | | | | | | | | | | | | | | | | | | | | | | | |
| 1/2 ss | | | | | | | | | | | | | | | | | | | | | | | | | | | | | | | | | | | | | | | | | | | | | | | | | | | | | | | | | | | | | | | | | | | | | | | | | | | | | | | | | | | | | | | | | | | | | | | | | | | | | | | | | | | | | | | | | | | | | | | | | | | | | | | | | | | | | | | | | | | | | | | | | | | | | | | | | | | | | | | | | | | | | | | | | | | | | | | | | | | | | | | | | | | | | | | | | | | | | | | | | | | | | | | | | | | | | | | | | | | | | | | | | | | | | | | | | | | | | | | | | | | | | | | | | | | | | | | | | | | | | | | | | | | | | | | | | | | | | | | | | | | | | | | | | | | | | | | | | | | | | | | | | | | | | | | | | | | | | | | | | | | | | | | | | | | | | | | | | | | | | | | | | | | | | | | | | | | | | | | | | | | | | | | | | | | | | | | | | | | | | | | | | | | | | | | | | | | | | | | | | | | | | | | | | | | | | | | | | | | | | | | | | | | | | | | | | | | | | | | | | | | | | | | | | | | | | | | | | | | | | | | | | | | | | | | | | | | | | | | | | | | | | | | | | | | | | | | | | | | | | | | | | | | | | | | | | | | | | | | | | | | | | | | | | | | | | | | | | | | | | | | | | | | | | | | | | | | | | | | | | | | | | | | | | | | | | | | | | | | | | | | | | | | | | | | | | | | | | | | | | | | | | | | | |
| 2 | 4 | 6 | 8 | 10 | | | | | | | | | | | | | | | | | | | | | | | | | | | | | | | | | | | | | | | | | | | | | | | | | | | | | | | | | | | | | | | | | | | | | | | | | | | | | | | | | | | | | | | | | | | | | | | | | | | | | | | | | | | | | | | | | | | | | | | | | | | | | | | | | | | | | | | | | | | | | | | | | | | | | | | | | | | | | | | | | | | | | | | | | | | | | | | | | | | | | | | | | | | | | | | | | | | | | | | | | | | | | | | | | | | | | | | | | | | | | | | | | | | | | | | | | | | | | | | | | | | | | | | | | | | | | | | | | | | | | | | | | | | | | | | | | | | | | | | | | | | | | | | | | | | | | | | | | | | | | | | | | | | | | | | | | | | | | | | | | | | | | | | | | | | | | | | | | | | | | | | | | | | | | | | | | | | | | | | | | | | | | | | | | | | | | | | | | | | | | | | | | | | | | | | | | | | | | | | | | | | | | | | | | | | | | | | | | | | | | | | | | | | | | | | | | | | | | | | | | | | | | | | | | | | | | | | | | | | | | | | | | | | | | | | | | | | | | | | | | | | | | | | | | | | | | | | | | | | | | | | | | | | | | | | | | | | | | | | | | | | | | | | | | | | | | | | | | | | | | | | | | | | | | | | | | | | | | | | | | | | | | | | | | | | | | | | | | | | | | | | | | | | | | | | | | | | | | | | | | | | | |
| 1 | 0.0 | 0.2 | 0.4 | 0.6 | | | | | | | | | | | | | | | | | | | | | | | | | | | | | | | | | | | | | | | | | | | | | | | | | | | | | | | | | | | | | | | | | | | | | | | | | | | | | | | | | | | | | | | | | | | | | | | | | | | | | | | | | | | | | | | | | | | | | | | | | | | | | | | | | | | | | | | | | | | | | | | | | | | | | | | | | | | | | | | | | | | | | | | | | | | | | | | | | | | | | | | | | | | | | | | | | | | | | | | | | | | | | | | | | | | | | | | | | | | | | | | | | | | | | | | | | | | | | | | | | | | | | | | | | | | | | | | | | | | | | | | | | | | | | | | | | | | | | | | | | | | | | | | | | | | | | | | | | | | | | | | | | | | | | | | | | | | | | | | | | | | | | | | | | | | | | | | | | | | | | | | | | | | | | | | | | | | | | | | | | | | | | | | | | | | | | | | | | | | | | | | | | | | | | | | | | | | | | | | | | | | | | | | | | | | | | | | | | | | | | | | | | | | | | | | | | | | | | | | | | | | | | | | | | | | | | | | | | | | | | | | | | | | | | | | | | | | | | | | | | | | | | | | | | | | | | | | | | | | | | | | | | | | | | | | | | | | | | | | | | | | | | | | | | | | | | | | | | | | | | | | | | | | | | | | | | | | | | | | | | | | | | | | | | | | | | | | | | | | | | | | | | | | | | | | | | | | | | | | | | | | | |
| 3 | 0.5 | 0.9 | 1.4 | 2.0 | | | | | | | | | | | | | | | | | | | | | | | | | | | | | | | | | | | | | | | | | | | | | | | | | | | | | | | | | | | | | | | | | | | | | | | | | | | | | | | | | | | | | | | | | | | | | | | | | | | | | | | | | | | | | | | | | | | | | | | | | | | | | | | | | | | | | | | | | | | | | | | | | | | | | | | | | | | | | | | | | | | | | | | | | | | | | | | | | | | | | | | | | | | | | | | | | | | | | | | | | | | | | | | | | | | | | | | | | | | | | | | | | | | | | | | | | | | | | | | | | | | | | | | | | | | | | | | | | | | | | | | | | | | | | | | | | | | | | | | | | | | | | | | | | | | | | | | | | | | | | | | | | | | | | | | | | | | | | | | | | | | | | | | | | | | | | | | | | | | | | | | | | | | | | | | | | | | | | | | | | | | | | | | | | | | | | | | | | | | | | | | | | | | | | | | | | | | | | | | | | | | | | | | | | | | | | | | | | | | | | | | | | | | | | | | | | | | | | | | | | | | | | | | | | | | | | | | | | | | | | | | | | | | | | | | | | | | | | | | | | | | | | | | | | | | | | | | | | | | | | | | | | | | | | | | | | | | | | | | | | | | | | | | | | | | | | | | | | | | | | | | | | | | | | | | | | | | | | | | | | | | | | | | | | | | | | | | | | | | | | | | | | | | | | | | | | | | | | | | | | | | | |
| 5 | 1.0 | 1.5 | 2.0 | 2.5 | | | | | | | | | | | | | | | | | | | | | | | | | | | | | | | | | | | | | | | | | | | | | | | | | | | | | | | | | | | | | | | | | | | | | | | | | | | | | | | | | | | | | | | | | | | | | | | | | | | | | | | | | | | | | | | | | | | | | | | | | | | | | | | | | | | | | | | | | | | | | | | | | | | | | | | | | | | | | | | | | | | | | | | | | | | | | | | | | | | | | | | | | | | | | | | | | | | | | | | | | | | | | | | | | | | | | | | | | | | | | | | | | | | | | | | | | | | | | | | | | | | | | | | | | | | | | | | | | | | | | | | | | | | | | | | | | | | | | | | | | | | | | | | | | | | | | | | | | | | | | | | | | | | | | | | | | | | | | | | | | | | | | | | | | | | | | | | | | | | | | | | | | | | | | | | | | | | | | | | | | | | | | | | | | | | | | | | | | | | | | | | | | | | | | | | | | | | | | | | | | | | | | | | | | | | | | | | | | | | | | | | | | | | | | | | | | | | | | | | | | | | | | | | | | | | | | | | | | | | | | | | | | | | | | | | | | | | | | | | | | | | | | | | | | | | | | | | | | | | | | | | | | | | | | | | | | | | | | | | | | | | | | | | | | | | | | | | | | | | | | | | | | | | | | | | | | | | | | | | | | | | | | | | | | | | | | | | | | | | | | | | | | | | | | | | | | | | | | | | | | | | | |
| 7 | 1.4 | 1.9 | 2.4 | 2.9 | | | | | | | | | | | | | | | | | | | | | | | | | | | | | | | | | | | | | | | | | | | | | | | | | | | | | | | | | | | | | | | | | | | | | | | | | | | | | | | | | | | | | | | | | | | | | | | | | | | | | | | | | | | | | | | | | | | | | | | | | | | | | | | | | | | | | | | | | | | | | | | | | | | | | | | | | | | | | | | | | | | | | | | | | | | | | | | | | | | | | | | | | | | | | | | | | | | | | | | | | | | | | | | | | | | | | | | | | | | | | | | | | | | | | | | | | | | | | | | | | | | | | | | | | | | | | | | | | | | | | | | | | | | | | | | | | | | | | | | | | | | | | | | | | | | | | | | | | | | | | | | | | | | | | | | | | | | | | | | | | | | | | | | | | | | | | | | | | | | | | | | | | | | | | | | | | | | | | | | | | | | | | | | | | | | | | | | | | | | | | | | | | | | | | | | | | | | | | | | | | | | | | | | | | | | | | | | | | | | | | | | | | | | | | | | | | | | | | | | | | | | | | | | | | | | | | | | | | | | | | | | | | | | | | | | | | | | | | | | | | | | | | | | | | | | | | | | | | | | | | | | | | | | | | | | | | | | | | | | | | | | | | | | | | | | | | | | | | | | | | | | | | | | | | | | | | | | | | | | | | | | | | | | | | | | | | | | | | | | | | | | | | | | | | | | | | | | | | | | | | | | | |
| 9 | 1.8 | 2.3 | 2.8 | 3.3 | | | | | | | | | | | | | | | | | | | | | | | | | | | | | | | | | | | | | | | | | | | | | | | | | | | | | | | | | | | | | | | | | | | | | | | | | | | | | | | | | | | | | | | | | | | | | | | | | | | | | | | | | | | | | | | | | | | | | | | | | | | | | | | | | | | | | | | | | | | | | | | | | | | | | | | | | | | | | | | | | | | | | | | | | | | | | | | | | | | | | | | | | | | | | | | | | | | | | | | | | | | | | | | | | | | | | | | | | | | | | | | | | | | | | | | | | | | | | | | | | | | | | | | | | | | | | | | | | | | | | | | | | | | | | | | | | | | | | | | | | | | | | | | | | | | | | | | | | | | | | | | | | | | | | | | | | | | | | | | | | | | | | | | | | | | | | | | | | | | | | | | | | | | | | | | | | | | | | | | | | | | | | | | | | | | | | | | | | | | | | | | | | | | | | | | | | | | | | | | | | | | | | | | | | | | | | | | | | | | | | | | | | | | | | | | | | | | | | | | | | | | | | | | | | | | | | | | | | | | | | | | | | | | | | | | | | | | | | | | | | | | | | | | | | | | | | | | | | | | | | | | | | | | | | | | | | | | | | | | | | | | | | | | | | | | | | | | | | | | | | | | | | | | | | | | | | | | | | | | | | | | | | | | | | | | | | | | | | | | | | | | | | | | | | | | | | | | | | | | | | | | | |
| 1/2 ss | | | | | | | | | | | | | | | | | | | | | | | | | | | | | | | | | | | | | | | | | | | | | | | | | | | | | | | | | | | | | | | | | | | | | | | | | | | | | | | | | | | | | | | | | | | | | | | | | | | | | | | | | | | | | | | | | | | | | | | | | | | | | | | | | | | | | | | | | | | | | | | | | | | | | | | | | | | | | | | | | | | | | | | | | | | | | | | | | | | | | | | | | | | | | | | | | | | | | | | | | | | | | | | | | | | | | | | | | | | | | | | | | | | | | | | | | | | | | | | | | | | | | | | | | | | | | | | | | | | | | | | | | | | | | | | | | | | | | | | | | | | | | | | | | | | | | | | | | | | | | | | | | | | | | | | | | | | | | | | | | | | | | | | | | | | | | | | | | | | | | | | | | | | | | | | | | | | | | | | | | | | | | | | | | | | | | | | | | | | | | | | | | | | | | | | | | | | | | | | | | | | | | | | | | | | | | | | | | | | | | | | | | | | | | | | | | | | | | | | | | | | | | | | | | | | | | | | | | | | | | | | | | | | | | | | | | | | | | | | | | | | | | | | | | | | | | | | | | | | | | | | | | | | | | | | | | | | | | | | | | | | | | | | | | | | | | | | | | | | | | | | | | | | | | | | | | | | | | | | | | | | | | | | | | | | | | | | | | | | | | | | | | | | | | | | | | | | | | | | | | | | | | | | | |
| 2 | 4 | 6 | 8 | 10 | | | | | | | | | | | | | | | | | | | | | | | | | | | | | | | | | | | | | | | | | | | | | | | | | | | | | | | | | | | | | | | | | | | | | | | | | | | | | | | | | | | | | | | | | | | | | | | | | | | | | | | | | | | | | | | | | | | | | | | | | | | | | | | | | | | | | | | | | | | | | | | | | | | | | | | | | | | | | | | | | | | | | | | | | | | | | | | | | | | | | | | | | | | | | | | | | | | | | | | | | | | | | | | | | | | | | | | | | | | | | | | | | | | | | | | | | | | | | | | | | | | | | | | | | | | | | | | | | | | | | | | | | | | | | | | | | | | | | | | | | | | | | | | | | | | | | | | | | | | | | | | | | | | | | | | | | | | | | | | | | | | | | | | | | | | | | | | | | | | | | | | | | | | | | | | | | | | | | | | | | | | | | | | | | | | | | | | | | | | | | | | | | | | | | | | | | | | | | | | | | | | | | | | | | | | | | | | | | | | | | | | | | | | | | | | | | | | | | | | | | | | | | | | | | | | | | | | | | | | | | | | | | | | | | | | | | | | | | | | | | | | | | | | | | | | | | | | | | | | | | | | | | | | | | | | | | | | | | | | | | | | | | | | | | | | | | | | | | | | | | | | | | | | | | | | | | | | | | | | | | | | | | | | | | | | | | | | | | | | | | | | | | | | | | | | | | | | | | | | | | | | | |
| 1 | 0.8 | 1.3 | 1.8 | 2.3 | | | | | | | | | | | | | | | | | | | | | | | | | | | | | | | | | | | | | | | | | | | | | | | | | | | | | | | | | | | | | | | | | | | | | | | | | | | | | | | | | | | | | | | | | | | | | | | | | | | | | | | | | | | | | | | | | | | | | | | | | | | | | | | | | | | | | | | | | | | | | | | | | | | | | | | | | | | | | | | | | | | | | | | | | | | | | | | | | | | | | | | | | | | | | | | | | | | | | | | | | | | | | | | | | | | | | | | | | | | | | | | | | | | | | | | | | | | | | | | | | | | | | | | | | | | | | | | | | | | | | | | | | | | | | | | | | | | | | | | | | | | | | | | | | | | | | | | | | | | | | | | | | | | | | | | | | | | | | | | | | | | | | | | | | | | | | | | | | | | | | | | | | | | | | | | | | | | | | | | | | | | | | | | | | | | | | | | | | | | | | | | | | | | | | | | | | | | | | | | | | | | | | | | | | | | | | | | | | | | | | | | | | | | | | | | | | | | | | | | | | | | | | | | | | | | | | | | | | | | | | | | | | | | | | | | | | | | | | | | | | | | | | | | | | | | | | | | | | | | | | | | | | | | | | | | | | | | | | | | | | | | | | | | | | | | | | | | | | | | | | | | | | | | | | | | | | | | | | | | | | | | | | | | | | | | | | | | | | | | | | | | | | | | | | | | | | | | | | | | | | | | | |
| 4 | 1.3 | 1.8 | 2.3 | 2.8 | | | | | | | | | | | | | | | | | | | | | | | | | | | | | | | | | | | | | | | | | | | | | | | | | | | | | | | | | | | | | | | | | | | | | | | | | | | | | | | | | | | | | | | | | | | | | | | | | | | | | | | | | | | | | | | | | | | | | | | | | | | | | | | | | | | | | | | | | | | | | | | | | | | | | | | | | | | | | | | | | | | | | | | | | | | | | | | | | | | | | | | | | | | | | | | | | | | | | | | | | | | | | | | | | | | | | | | | | | | | | | | | | | | | | | | | | | | | | | | | | | | | | | | | | | | | | | | | | | | | | | | | | | | | | | | | | | | | | | | | | | | | | | | | | | | | | | | | | | | | | | | | | | | | | | | | | | | | | | | | | | | | | | | | | | | | | | | | | | | | | | | | | | | | | | | | | | | | | | | | | | | | | | | | | | | | | | | | | | | | | | | | | | | | | | | | | | | | | | | | | | | | | | | | | | | | | | | | | | | | | | | | | | | | | | | | | | | | | | | | | | | | | | | | | | | | | | | | | | | | | | | | | | | | | | | | | | | | | | | | | | | | | | | | | | | | | | | | | | | | | | | | | | | | | | | | | | | | | | | | | | | | | | | | | | | | | | | | | | | | | | | | | | | | | | | | | | | | | | | | | | | | | | | | | | | | | | | | | | | | | | | | | | | | | | | | | | | | | | | | | | | | |
| 6 | 1.9 | 2.4 | 2.9 | 3.4 | | | | | | | | | | | | | | | | | | | | | | | | | | | | | | | | | | | | | | | | | | | | | | | | | | | | | | | | | | | | | | | | | | | | | | | | | | | | | | | | | | | | | | | | | | | | | | | | | | | | | | | | | | | | | | | | | | | | | | | | | | | | | | | | | | | | | | | | | | | | | | | | | | | | | | | | | | | | | | | | | | | | | | | | | | | | | | | | | | | | | | | | | | | | | | | | | | | | | | | | | | | | | | | | | | | | | | | | | | | | | | | | | | | | | | | | | | | | | | | | | | | | | | | | | | | | | | | | | | | | | | | | | | | | | | | | | | | | | | | | | | | | | | | | | | | | | | | | | | | | | | | | | | | | | | | | | | | | | | | | | | | | | | | | | | | | | | | | | | | | | | | | | | | | | | | | | | | | | | | | | | | | | | | | | | | | | | | | | | | | | | | | | | | | | | | | | | | | | | | | | | | | | | | | | | | | | | | | | | | | | | | | | | | | | | | | | | | | | | | | | | | | | | | | | | | | | | | | | | | | | | | | | | | | | | | | | | | | | | | | | | | | | | | | | | | | | | | | | | | | | | | | | | | | | | | | | | | | | | | | | | | | | | | | | | | | | | | | | | | | | | | | | | | | | | | | | | | | | | | | | | | | | | | | | | | | | | | | | | | | | | | | | | | | | | | | | | | | | | | | | | | | |
| 1/2 ss | | | | | | | | | | | | | | | | | | | | | | | | | | | | | | | | | | | | | | | | | | | | | | | | | | | | | | | | | | | | | | | | | | | | | | | | | | | | | | | | | | | | | | | | | | | | | | | | | | | | | | | | | | | | | | | | | | | | | | | | | | | | | | | | | | | | | | | | | | | | | | | | | | | | | | | | | | | | | | | | | | | | | | | | | | | | | | | | | | | | | | | | | | | | | | | | | | | | | | | | | | | | | | | | | | | | | | | | | | | | | | | | | | | | | | | | | | | | | | | | | | | | | | | | | | | | | | | | | | | | | | | | | | | | | | | | | | | | | | | | | | | | | | | | | | | | | | | | | | | | | | | | | | | | | | | | | | | | | | | | | | | | | | | | | | | | | | | | | | | | | | | | | | | | | | | | | | | | | | | | | | | | | | | | | | | | | | | | | | | | | | | | | | | | | | | | | | | | | | | | | | | | | | | | | | | | | | | | | | | | | | | | | | | | | | | | | | | | | | | | | | | | | | | | | | | | | | | | | | | | | | | | | | | | | | | | | | | | | | | | | | | | | | | | | | | | | | | | | | | | | | | | | | | | | | | | | | | | | | | | | | | | | | | | | | | | | | | | | | | | | | | | | | | | | | | | | | | | | | | | | | | | | | | | | | | | | | | | | | | | | | | | | | | | | | | | | | | | | | | | | | | | | | | | |
| 2 | 4 | 6 | 8 | 10 | | | | | | | | | | | | | | | | | | | | | | | | | | | | | | | | | | | | | | | | | | | | | | | | | | | | | | | | | | | | | | | | | | | | | | | | | | | | | | | | | | | | | | | | | | | | | | | | | | | | | | | | | | | | | | | | | | | | | | | | | | | | | | | | | | | | | | | | | | | | | | | | | | | | | | | | | | | | | | | | | | | | | | | | | | | | | | | | | | | | | | | | | | | | | | | | | | | | | | | | | | | | | | | | | | | | | | | | | | | | | | | | | | | | | | | | | | | | | | | | | | | | | | | | | | | | | | | | | | | | | | | | | | | | | | | | | | | | | | | | | | | | | | | | | | | | | | | | | | | | | | | | | | | | | | | | | | | | | | | | | | | | | | | | | | | | | | | | | | | | | | | | | | | | | | | | | | | | | | | | | | | | | | | | | | | | | | | | | | | | | | | | | | | | | | | | | | | | | | | | | | | | | | | | | | | | | | | | | | | | | | | | | | | | | | | | | | | | | | | | | | | | | | | | | | | | | | | | | | | | | | | | | | | | | | | | | | | | | | | | | | | | | | | | | | | | | | | | | | | | | | | | | | | | | | | | | | | | | | | | | | | | | | | | | | | | | | | | | | | | | | | | | | | | | | | | | | | | | | | | | | | | | | | | | | | | | | | | | | | | | | | | | | | | | | | | | | | | | | | | | | | | |
| 0.2 | 0.5 | 0.8 | 1.2 | 1.6 | | | | | | | | | | | | | | | | | | | | | | | | | | | | | | | | | | | | | | | | | | | | | | | | | | | | | | | | | | | | | | | | | | | | | | | | | | | | | | | | | | | | | | | | | | | | | | | | | | | | | | | | | | | | | | | | | | | | | | | | | | | | | | | | | | | | | | | | | | | | | | | | | | | | | | | | | | | | | | | | | | | | | | | | | | | | | | | | | | | | | | | | | | | | | | | | | | | | | | | | | | | | | | | | | | | | | | | | | | | | | | | | | | | | | | | | | | | | | | | | | | | | | | | | | | | | | | | | | | | | | | | | | | | | | | | | | | | | | | | | | | | | | | | | | | | | | | | | | | | | | | | | | | | | | | | | | | | | | | | | | | | | | | | | | | | | | | | | | | | | | | | | | | | | | | | | | | | | | | | | | | | | | | | | | | | | | | | | | | | | | | | | | | | | | | | | | | | | | | | | | | | | | | | | | | | | | | | | | | | | | | | | | | | | | | | | | | | | | | | | | | | | | | | | | | | | | | | | | | | | | | | | | | | | | | | | | | | | | | | | | | | | | | | | | | | | | | | | | | | | | | | | | | | | | | | | | | | | | | | | | | | | | | | | | | | | | | | | | | | | | | | | | | | | | | | | | | | | | | | | | | | | | | | | | | | | | | | | | | | | | | | | | | | | | | | | | | | | | | | | | | | | |
| 1/2 ss | | | | | | | | | | | | | | | | | | | | | | | | | | | | | | | | | | | | | | | | | | | | | | | | | | | | | | | | | | | | | | | | | | | | | | | | | | | | | | | | | | | | | | | | | | | | | | | | | | | | | | | | | | | | | | | | | | | | | | | | | | | | | | | | | | | | | | | | | | | | | | | | | | | | | | | | | | | | | | | | | | | | | | | | | | | | | | | | | | | | | | | | | | | | | | | | | | | | | | | | | | | | | | | | | | | | | | | | | | | | | | | | | | | | | | | | | | | | | | | | | | | | | | | | | | | | | | | | | | | | | | | | | | | | | | | | | | | | | | | | | | | | | | | | | | | | | | | | | | | | | | | | | | | | | | | | | | | | | | | | | | | | | | | | | | | | | | | | | | | | | | | | | | | | | | | | | | | | | | | | | | | | | | | | | | | | | | | | | | | | | | | | | | | | | | | | | | | | | | | | | | | | | | | | | | | | | | | | | | | | | | | | | | | | | | | | | | | | | | | | | | | | | | | | | | | | | | | | | | | | | | | | | | | | | | | | | | | | | | | | | | | | | | | | | | | | | | | | | | | | | | | | | | | | | | | | | | | | | | | | | | | | | | | | | | | | | | | | | | | | | | | | | | | | | | | | | | | | | | | | | | | | | | | | | | | | | | | | | | | | | | | | | | | | | | | | | | | | | | | | | | | | | | | | |
| 2 | 4 | 6 | 8 | 10 | | | | | | | | | | | | | | | | | | | | | | | | | | | | | | | | | | | | | | | | | | | | | | | | | | | | | | | | | | | | | | | | | | | | | | | | | | | | | | | | | | | | | | | | | | | | | | | | | | | | | | | | | | | | | | | | | | | | | | | | | | | | | | | | | | | | | | | | | | | | | | | | | | | | | | | | | | | | | | | | | | | | | | | | | | | | | | | | | | | | | | | | | | | | | | | | | | | | | | | | | | | | | | | | | | | | | | | | | | | | | | | | | | | | | | | | | | | | | | | | | | | | | | | | | | | | | | | | | | | | | | | | | | | | | | | | | | | | | | | | | | | | | | | | | | | | | | | | | | | | | | | | | | | | | | | | | | | | | | | | | | | | | | | | | | | | | | | | | | | | | | | | | | | | | | | | | | | | | | | | | | | | | | | | | | | | | | | | | | | | | | | | | | | | | | | | | | | | | | | | | | | | | | | | | | | | | | | | | | | | | | | | | | | | | | | | | | | | | | | | | | | | | | | | | | | | | | | | | | | | | | | | | | | | | | | | | | | | | | | | | | | | | | | | | | | | | | | | | | | | | | | | | | | | | | | | | | | | | | | | | | | | | | | | | | | | | | | | | | | | | | | | | | | | | | | | | | | | | | | | | | | | | | | | | | | | | | | | | | | | | | | | | | | | | | | | | | | | | | | | | | | | |
| 2.4 | 2.7 | 3.2 | 4.2 | 5.7 | | | | | | | | | | | | | | | | | | | | | | | | | | | | | | | | | | | | | | | | | | | | | | | | | | | | | | | | | | | | | | | | | | | | | | | | | | | | | | | | | | | | | | | | | | | | | | | | | | | | | | | | | | | | | | | | | | | | | | | | | | | | | | | | | | | | | | | | | | | | | | | | | | | | | | | | | | | | | | | | | | | | | | | | | | | | | | | | | | | | | | | | | | | | | | | | | | | | | | | | | | | | | | | | | | | | | | | | | | | | | | | | | | | | | | | | | | | | | | | | | | | | | | | | | | | | | | | | | | | | | | | | | | | | | | | | | | | | | | | | | | | | | | | | | | | | | | | | | | | | | | | | | | | | | | | | | | | | | | | | | | | | | | | | | | | | | | | | | | | | | | | | | | | | | | | | | | | | | | | | | | | | | | | | | | | | | | | | | | | | | | | | | | | | | | | | | | | | | | | | | | | | | | | | | | | | | | | | | | | | | | | | | | | | | | | | | | | | | | | | | | | | | | | | | | | | | | | | | | | | | | | | | | | | | | | | | | | | | | | | | | | | | | | | | | | | | | | | | | | | | | | | | | | | | | | | | | | | | | | | | | | | | | | | | | | | | | | | | | | | | | | | | | | | | | | | | | | | | | | | | | | | | | | | | | | | | | | | | | | | | | | | | | | | | | | | | | | | | | | | | | | | |
| 1/2 ss | | | | | | | | | | | | | | | | | | | | | | | | | | | | | | | | | | | | | | | | | | | | | | | | | | | | | | | | | | | | | | | | | | | | | | | | | | | | | | | | | | | | | | | | | | | | | | | | | | | | | | | | | | | | | | | | | | | | | | | | | | | | | | | | | | | | | | | | | | | | | | | | | | | | | | | | | | | | | | | | | | | | | | | | | | | | | | | | | | | | | | | | | | | | | | | | | | | | | | | | | | | | | | | | | | | | | | | | | | | | | | | | | | | | | | | | | | | | | | | | | | | | | | | | | | | | | | | | | | | | | | | | | | | | | | | | | | | | | | | | | | | | | | | | | | | | | | | | | | | | | | | | | | | | | | | | | | | | | | | | | | | | | | | | | | | | | | | | | | | | | | | | | | | | | | | | | | | | | | | | | | | | | | | | | | | | | | | | | | | | | | | | | | | | | | | | | | | | | | | | | | | | | | | | | | | | | | | | | | | | | | | | | | | | | | | | | | | | | | | | | | | | | | | | | | | | | | | | | | | | | | | | | | | | | | | | | | | | | | | | | | | | | | | | | | | | | | | | | | | | | | | | | | | | | | | | | | | | | | | | | | | | | | | | | | | | | | | | | | | | | | | | | | | | | | | | | | | | | | | | | | | | | | | | | | | | | | | | | | | | | | | | | | | | | | | | | | | | | | | | | | | | | | | | |
| 2 | 4 | 6 | 8 | 10 | | | | | | | | | | | | | | | | | | | | | | | | | | | | | | | | | | | | | | | | | | | | | | | | | | | | | | | | | | | | | | | | | | | | | | | | | | | | | | | | | | | | | | | | | | | | | | | | | | | | | | | | | | | | | | | | | | | | | | | | | | | | | | | | | | | | | | | | | | | | | | | | | | | | | | | | | | | | | | | | | | | | | | | | | | | | | | | | | | | | | | | | | | | | | | | | | | | | | | | | | | | | | | | | | | | | | | | | | | | | | | | | | | | | | | | | | | | | | | | | | | | | | | | | | | | | | | | | | | | | | | | | | | | | | | | | | | | | | | | | | | | | | | | | | | | | | | | | | | | | | | | | | | | | | | | | | | | | | | | | | | | | | | | | | | | | | | | | | | | | | | | | | | | | | | | | | | | | | | | | | | | | | | | | | | | | | | | | | | | | | | | | | | | | | | | | | | | | | | | | | | | | | | | | | | | | | | | | | | | | | | | | | | | | | | | | | | | | | | | | | | | | | | | | | | | | | | | | | | | | | | | | | | | | | | | | | | | | | | | | | | | | | | | | | | | | | | | | | | | | | | | | | | | | | | | | | | | | | | | | | | | | | | | | | | | | | | | | | | | | | | | | | | | | | | | | | | | | | | | | | | | | | | | | | | | | | | | | | | | | | | | | | | | | | | | | | | | | | | | | | | | | |
| 0.2 | 0.3 | 0.5 | 0.7 | 0.9 | | | | | | | | | | | | | | | | | | | | | | | | | | | | | | | | | | | | | | | | | | | | | | | | | | | | | | | | | | | | | | | | | | | | | | | | | | | | | | | | | | | | | | | | | | | | | | | | | | | | | | | | | | | | | | | | | | | | | | | | | | | | | | | | | | | | | | | | | | | | | | | | | | | | | | | | | | | | | | | | | | | | | | | | | | | | | | | | | | | | | | | | | | | | | | | | | | | | | | | | | | | | | | | | | | | | | | | | | | | | | | | | | | | | | | | | | | | | | | | | | | | | | | | | | | | | | | | | | | | | | | | | | | | | | | | | | | | | | | | | | | | | | | | | | | | | | | | | | | | | | | | | | | | | | | | | | | | | | | | | | | | | | | | | | | | | | | | | | | | | | | | | | | | | | | | | | | | | | | | | | | | | | | | | | | | | | | | | | | | | | | | | | | | | | | | | | | | | | | | | | | | | | | | | | | | | | | | | | | | | | | | | | | | | | | | | | | | | | | | | | | | | | | | | | | | | | | | | | | | | | | | | | | | | | | | | | | | | | | | | | | | | | | | | | | | | | | | | | | | | | | | | | | | | | | | | | | | | | | | | | | | | | | | | | | | | | | | | | | | | | | | | | | | | | | | | | | | | | | | | | | | | | | | | | | | | | | | | | | | | | | | | | | | | | | | | | | | | | | | | | | | | |
| 1/2 ss | | | | | | | | | | | | | | | | | | | | | | | | | | | | | | | | | | | | | | | | | | | | | | | | | | | | | | | | | | | | | | | | | | | | | | | | | | | | | | | | | | | | | | | | | | | | | | | | | | | | | | | | | | | | | | | | | | | | | | | | | | | | | | | | | | | | | | | | | | | | | | | | | | | | | | | | | | | | | | | | | | | | | | | | | | | | | | | | | | | | | | | | | | | | | | | | | | | | | | | | | | | | | | | | | | | | | | | | | | | | | | | | | | | | | | | | | | | | | | | | | | | | | | | | | | | | | | | | | | | | | | | | | | | | | | | | | | | | | | | | | | | | | | | | | | | | | | | | | | | | | | | | | | | | | | | | | | | | | | | | | | | | | | | | | | | | | | | | | | | | | | | | | | | | | | | | | | | | | | | | | | | | | | | | | | | | | | | | | | | | | | | | | | | | | | | | | | | | | | | | | | | | | | | | | | | | | | | | | | | | | | | | | | | | | | | | | | | | | | | | | | | | | | | | | | | | | | | | | | | | | | | | | | | | | | | | | | | | | | | | | | | | | | | | | | | | | | | | | | | | | | | | | | | | | | | | | | | | | | | | | | | | | | | | | | | | | | | | | | | | | | | | | | | | | | | | | | | | | | | | | | | | | | | | | | | | | | | | | | | | | | | | | | | | | | | | | | | | | | | | | | | | | | | | |
| 2 | 4 | 6 | 8 | 10 | | | | | | | | | | | | | | | | | | | | | | | | | | | | | | | | | | | | | | | | | | | | | | | | | | | | | | | | | | | | | | | | | | | | | | | | | | | | | | | | | | | | | | | | | | | | | | | | | | | | | | | | | | | | | | | | | | | | | | | | | | | | | | | | | | | | | | | | | | | | | | | | | | | | | | | | | | | | | | | | | | | | | | | | | | | | | | | | | | | | | | | | | | | | | | | | | | | | | | | | | | | | | | | | | | | | | | | | | | | | | | | | | | | | | | | | | | | | | | | | | | | | | | | | | | | | | | | | | | | | | | | | | | | | | | | | | | | | | | | | | | | | | | | | | | | | | | | | | | | | | | | | | | | | | | | | | | | | | | | | | | | | | | | | | | | | | | | | | | | | | | | | | | | | | | | | | | | | | | | | | | | | | | | | | | | | | | | | | | | | | | | | | | | | | | | | | | | | | | | | | | | | | | | | | | | | | | | | | | | | | | | | | | | | | | | | | | | | | | | | | | | | | | | | | | | | | | | | | | | | | | | | | | | | | | | | | | | | | | | | | | | | | | | | | | | | | | | | | | | | | | | | | | | | | | | | | | | | | | | | | | | | | | | | | | | | | | | | | | | | | | | | | | | | | | | | | | | | | | | | | | | | | | | | | | | | | | | | | | | | | | | | | | | | | | | | | | | | | | | | | | | | |
| 2 | 0.1 | 0.2 | 0.3 | 0.4 | | | | | | | | | | | | | | | | | | | | | | | | | | | | | | | | | | | | | | | | | | | | | | | | | | | | | | | | | | | | | | | | | | | | | | | | | | | | | | | | | | | | | | | | | | | | | | | | | | | | | | | | | | | | | | | | | | | | | | | | | | | | | | | | | | | | | | | | | | | | | | | | | | | | | | | | | | | | | | | | | | | | | | | | | | | | | | | | | | | | | | | | | | | | | | | | | | | | | | | | | | | | | | | | | | | | | | | | | | | | | | | | | | | | | | | | | | | | | | | | | | | | | | | | | | | | | | | | | | | | | | | | | | | | | | | | | | | | | | | | | | | | | | | | | | | | | | | | | | | | | | | | | | | | | | | | | | | | | | | | | | | | | | | | | | | | | | | | | | | | | | | | | | | | | | | | | | | | | | | | | | | | | | | | | | | | | | | | | | | | | | | | | | | | | | | | | | | | | | | | | | | | | | | | | | | | | | | | | | | | | | | | | | | | | | | | | | | | | | | | | | | | | | | | | | | | | | | | | | | | | | | | | | | | | | | | | | | | | | | | | | | | | | | | | | | | | | | | | | | | | | | | | | | | | | | | | | | | | | | | | | | | | | | | | | | | | | | | | | | | | | | | | | | | | | | | | | | | | | | | | | | | | | | | | | | | | | | | | | | | | | | | | | | | | | | | | | | | | | | | | | | | |
| 4 | 0.5 | 0.8 | 1.1 | 1.4 | | | | | | | | | | | | | | | | | | | | | | | | | | | | | | | | | | | | | | | | | | | | | | | | | | | | | | | | | | | | | | | | | | | | | | | | | | | | | | | | | | | | | | | | | | | | | | | | | | | | | | | | | | | | | | | | | | | | | | | | | | | | | | | | | | | | | | | | | | | | | | | | | | | | | | | | | | | | | | | | | | | | | | | | | | | | | | | | | | | | | | | | | | | | | | | | | | | | | | | | | | | | | | | | | | | | | | | | | | | | | | | | | | | | | | | | | | | | | | | | | | | | | | | | | | | | | | | | | | | | | | | | | | | | | | | | | | | | | | | | | | | | | | | | | | | | | | | | | | | | | | | | | | | | | | | | | | | | | | | | | | | | | | | | | | | | | | | | | | | | | | | | | | | | | | | | | | | | | | | | | | | | | | | | | | | | | | | | | | | | | | | | | | | | | | | | | | | | | | | | | | | | | | | | | | | | | | | | | | | | | | | | | | | | | | | | | | | | | | | | | | | | | | | | | | | | | | | | | | | | | | | | | | | | | | | | | | | | | | | | | | | | | | | | | | | | | | | | | | | | | | | | | | | | | | | | | | | | | | | | | | | | | | | | | | | | | | | | | | | | | | | | | | | | | | | | | | | | | | | | | | | | | | | | | | | | | | | | | | | | | | | | | | | | | | | | | | | | | | | | | | | | |
| 6 | 0.9 | 1.4 | 1.9 | 2.4 | | | | | | | | | | | | | | | | | | | | | | | | | | | | | | | | | | | | | | | | | | | | | | | | | | | | | | | | | | | | | | | | | | | | | | | | | | | | | | | | | | | | | | | | | | | | | | | | | | | | | | | | | | | | | | | | | | | | | | | | | | | | | | | | | | | | | | | | | | | | | | | | | | | | | | | | | | | | | | | | | | | | | | | | | | | | | | | | | | | | | | | | | | | | | | | | | | | | | | | | | | | | | | | | | | | | | | | | | | | | | | | | | | | | | | | | | | | | | | | | | | | | | | | | | | | | | | | | | | | | | | | | | | | | | | | | | | | | | | | | | | | | | | | | | | | | | | | | | | | | | | | | | | | | | | | | | | | | | | | | | | | | | | | | | | | | | | | | | | | | | | | | | | | | | | | | | | | | | | | | | | | | | | | | | | | | | | | | | | | | | | | | | | | | | | | | | | | | | | | | | | | | | | | | | | | | | | | | | | | | | | | | | | | | | | | | | | | | | | | | | | | | | | | | | | | | | | | | | | | | | | | | | | | | | | | | | | | | | | | | | | | | | | | | | | | | | | | | | | | | | | | | | | | | | | | | | | | | | | | | | | | | | | | | | | | | | | | | | | | | | | | | | | | | | | | | | | | | | | | | | | | | | | | | | | | | | | | | | | | | | | | | | | | | | | | | | | | | | | | | | | | | |
| 8 | 1.3 | 1.8 | 2.3 | 2.8 | | | | | | | | | | | | | | | | | | | | | | | | | | | | | | | | | | | | | | | | | | | | | | | | | | | | | | | | | | | | | | | | | | | | | | | | | | | | | | | | | | | | | | | | | | | | | | | | | | | | | | | | | | | | | | | | | | | | | | | | | | | | | | | | | | | | | | | | | | | | | | | | | | | | | | | | | | | | | | | | | | | | | | | | | | | | | | | | | | | | | | | | | | | | | | | | | | | | | | | | | | | | | | | | | | | | | | | | | | | | | | | | | | | | | | | | | | | | | | | | | | | | | | | | | | | | | | | | | | | | | | | | | | | | | | | | | | | | | | | | | | | | | | | | | | | | | | | | | | | | | | | | | | | | | | | | | | | | | | | | | | | | | | | | | | | | | | | | | | | | | | | | | | | | | | | | | | | | | | | | | | | | | | | | | | | | | | | | | | | | | | | | | | | | | | | | | | | | | | | | | | | | | | | | | | | | | | | | | | | | | | | | | | | | | | | | | | | | | | | | | | | | | | | | | | | | | | | | | | | | | | | | | | | | | | | | | | | | | | | | | | | | | | | | | | | | | | | | | | | | | | | | | | | | | | | | | | | | | | | | | | | | | | | | | | | | | | | | | | | | | | | | | | | | | | | | | | | | | | | | | | | | | | | | | | | | | | | | | | | | | | | | | | | | | | | | | | | | | | | | | | | | |
| 10 | 1.7 | 2.2 | 2.7 | 3.2 | | | | | | | | | | | | | | | | | | | | | | | | | | | | | | | | | | | | | | | | | | | | | | | | | | | | | | | | | | | | | | | | | | | | | | | | | | | | | | | | | | | | | | | | | | | | | | | | | | | | | | | | | | | | | | | | | | | | | | | | | | | | | | | | | | | | | | | | | | | | | | | | | | | | | | | | | | | | | | | | | | | | | | | | | | | | | | | | | | | | | | | | | | | | | | | | | | | | | | | | | | | | | | | | | | | | | | | | | | | | | | | | | | | | | | | | | | | | | | | | | | | | | | | | | | | | | | | | | | | | | | | | | | | | | | | | | | | | | | | | | | | | | | | | | | | | | | | | | | | | | | | | | | | | | | | | | | | | | | | | | | | | | | | | | | | | | | | | | | | | | | | | | | | | | | | | | | | | | | | | | | | | | | | | | | | | | | | | | | | | | | | | | | | | | | | | | | | | | | | | | | | | | | | | | | | | | | | | | | | | | | | | | | | | | | | | | | | | | | | | | | | | | | | | | | | | | | | | | | | | | | | | | | | | | | | | | | | | | | | | | | | | | | | | | | | | | | | | | | | | | | | | | | | | | | | | | | | | | | | | | | | | | | | | | | | | | | | | | | | | | | | | | | | | | | | | | | | | | | | | | | | | | | | | | | | | | | | | | | | | | | | | | | | | | | | | | | | | | | | | | | | | |
| 1/2 ss | | | | | | | | | | | | | | | | | | | | | | | | | | | | | | | | | | | | | | | | | | | | | | | | | | | | | | | | | | | | | | | | | | | | | | | | | | | | | | | | | | | | | | | | | | | | | | | | | | | | | | | | | | | | | | | | | | | | | | | | | | | | | | | | | | | | | | | | | | | | | | | | | | | | | | | | | | | | | | | | | | | | | | | | | | | | | | | | | | | | | | | | | | | | | | | | | | | | | | | | | | | | | | | | | | | | | | | | | | | | | | | | | | | | | | | | | | | | | | | | | | | | | | | | | | | | | | | | | | | | | | | | | | | | | | | | | | | | | | | | | | | | | | | | | | | | | | | | | | | | | | | | | | | | | | | | | | | | | | | | | | | | | | | | | | | | | | | | | | | | | | | | | | | | | | | | | | | | | | | | | | | | | | | | | | | | | | | | | | | | | | | | | | | | | | | | | | | | | | | | | | | | | | | | | | | | | | | | | | | | | | | | | | | | | | | | | | | | | | | | | | | | | | | | | | | | | | | | | | | | | | | | | | | | | | | | | | | | | | | | | | | | | | | | | | | | | | | | | | | | | | | | | | | | | | | | | | | | | | | | | | | | | | | | | | | | | | | | | | | | | | | | | | | | | | | | | | | | | | | | | | | | | | | | | | | | | | | | | | | | | | | | | | | | | | | | | | | | | | | | | | | | | | | | |
| 2 | 4 | 6 | 8 | 10 | | | | | | | | | | | | | | | | | | | | | | | | | | | | | | | | | | | | | | | | | | | | | | | | | | | | | | | | | | | | | | | | | | | | | | | | | | | | | | | | | | | | | | | | | | | | | | | | | | | | | | | | | | | | | | | | | | | | | | | | | | | | | | | | | | | | | | | | | | | | | | | | | | | | | | | | | | | | | | | | | | | | | | | | | | | | | | | | | | | | | | | | | | | | | | | | | | | | | | | | | | | | | | | | | | | | | | | | | | | | | | | | | | | | | | | | | | | | | | | | | | | | | | | | | | | | | | | | | | | | | | | | | | | | | | | | | | | | | | | | | | | | | | | | | | | | | | | | | | | | | | | | | | | | | | | | | | | | | | | | | | | | | | | | | | | | | | | | | | | | | | | | | | | | | | | | | | | | | | | | | | | | | | | | | | | | | | | | | | | | | | | | | | | | | | | | | | | | | | | | | | | | | | | | | | | | | | | | | | | | | | | | | | | | | | | | | | | | | | | | | | | | | | | | | | | | | | | | | | | | | | | | | | | | | | | | | | | | | | | | | | | | | | | | | | | | | | | | | | | | | | | | | | | | | | | | | | | | | | | | | | | | | | | | | | | | | | | | | | | | | | | | | | | | | | | | | | | | | | | | | | | | | | | | | | | | | | | | | | | | | | | | | | | | | | | | | | | | | | | | | | | | |
| 1 | 0.3 | 0.5 | 0.8 | 1.1 | | | | | | | | | | | | | | | | | | | | | | | | | | | | | | | | | | | | | | | | | | | | | | | | | | | | | | | | | | | | | | | | | | | | | | | | | | | | | | | | | | | | | | | | | | | | | | | | | | | | | | | | | | | | | | | | | | | | | | | | | | | | | | | | | | | | | | | | | | | | | | | | | | | | | | | | | | | | | | | | | | | | | | | | | | | | | | | | | | | | | | | | | | | | | | | | | | | | | | | | | | | | | | | | | | | | | | | | | | | | | | | | | | | | | | | | | | | | | | | | | | | | | | | | | | | | | | | | | | | | | | | | | | | | | | | | | | | | | | | | | | | | | | | | | | | | | | | | | | | | | | | | | | | | | | | | | | | | | | | | | | | | | | | | | | | | | | | | | | | | | | | | | | | | | | | | | | | | | | | | | | | | | | | | | | | | | | | | | | | | | | | | | | | | | | | | | | | | | | | | | | | | | | | | | | | | | | | | | | | | | | | | | | | | | | | | | | | | | | | | | | | | | | | | | | | | | | | | | | | | | | | | | | | | | | | | | | | | | | | | | | | | | | | | | | | | | | | | | | | | | | | | | | | | | | | | | | | | | | | | | | | | | | | | | | | | | | | | | | | | | | | | | | | | | | | | | | | | | | | | | | | | | | | | | | | | | | | | | | | | | | | | | | | | | | | | | | | | | | | | | | | | |
| 3 | 0.8 | 1.3 | 1.8 | 2.3 | | | | | | | | | | | | | | | | | | | | | | | | | | | | | | | | | | | | | | | | | | | | | | | | | | | | | | | | | | | | | | | | | | | | | | | | | | | | | | | | | | | | | | | | | | | | | | | | | | | | | | | | | | | | | | | | | | | | | | | | | | | | | | | | | | | | | | | | | | | | | | | | | | | | | | | | | | | | | | | | | | | | | | | | | | | | | | | | | | | | | | | | | | | | | | | | | | | | | | | | | | | | | | | | | | | | | | | | | | | | | | | | | | | | | | | | | | | | | | | | | | | | | | | | | | | | | | | | | | | | | | | | | | | | | | | | | | | | | | | | | | | | | | | | | | | | | | | | | | | | | | | | | | | | | | | | | | | | | | | | | | | | | | | | | | | | | | | | | | | | | | | | | | | | | | | | | | | | | | | | | | | | | | | | | | | | | | | | | | | | | | | | | | | | | | | | | | | | | | | | | | | | | | | | | | | | | | | | | | | | | | | | | | | | | | | | | | | | | | | | | | | | | | | | | | | | | | | | | | | | | | | | | | | | | | | | | | | | | | | | | | | | | | | | | | | | | | | | | | | | | | | | | | | | | | | | | | | | | | | | | | | | | | | | | | | | | | | | | | | | | | | | | | | | | | | | | | | | | | | | | | | | | | | | | | | | | | | | | | | | | | | | | | | | | | | | | | | | | | | | | | | | |
| 5 | 1.3 | 1.8 | 2.3 | 2.8 | | | | | | | | | | | | | | | | | | | | | | | | | | | | | | | | | | | | | | | | | | | | | | | | | | | | | | | | | | | | | | | | | | | | | | | | | | | | | | | | | | | | | | | | | | | | | | | | | | | | | | | | | | | | | | | | | | | | | | | | | | | | | | | | | | | | | | | | | | | | | | | | | | | | | | | | | | | | | | | | | | | | | | | | | | | | | | | | | | | | | | | | | | | | | | | | | | | | | | | | | | | | | | | | | | | | | | | | | | | | | | | | | | | | | | | | | | | | | | | | | | | | | | | | | | | | | | | | | | | | | | | | | | | | | | | | | | | | | | | | | | | | | | | | | | | | | | | | | | | | | | | | | | | | | | | | | | | | | | | | | | | | | | | | | | | | | | | | | | | | | | | | | | | | | | | | | | | | | | | | | | | | | | | | | | | | | | | | | | | | | | | | | | | | | | | | | | | | | | | | | | | | | | | | | | | | | | | | | | | | | | | | | | | | | | | | | | | | | | | | | | | | | | | | | | | | | | | | | | | | | | | | | | | | | | | | | | | | | | | | | | | | | | | | | | | | | | | | | | | | | | | | | | | | | | | | | | | | | | | | | | | | | | | | | | | | | | | | | | | | | | | | | | | | | | | | | | | | | | | | | | | | | | | | | | | | | | | | | | | | | | | | | | | | | | | | | | | | | | | | | | | | |
| 7 | 1.7 | 2.2 | 2.7 | 3.2 | | | | | | | | | | | | | | | | | | | | | | | | | | | | | | | | | | | | | | | | | | | | | | | | | | | | | | | | | | | | | | | | | | | | | | | | | | | | | | | | | | | | | | | | | | | | | | | | | | | | | | | | | | | | | | | | | | | | | | | | | | | | | | | | | | | | | | | | | | | | | | | | | | | | | | | | | | | | | | | | | | | | | | | | | | | | | | | | | | | | | | | | | | | | | | | | | | | | | | | | | | | | | | | | | | | | | | | | | | | | | | | | | | | | | | | | | | | | | | | | | | | | | | | | | | | | | | | | | | | | | | | | | | | | | | | | | | | | | | | | | | | | | | | | | | | | | | | | | | | | | | | | | | | | | | | | | | | | | | | | | | | | | | | | | | | | | | | | | | | | | | | | | | | | | | | | | | | | | | | | | | | | | | | | | | | | | | | | | | | | | | | | | | | | | | | | | | | | | | | | | | | | | | | | | | | | | | | | | | | | | | | | | | | | | | | | | | | | | | | | | | | | | | | | | | | | | | | | | | | | | | | | | | | | | | | | | | | | | | | | | | | | | | | | | | | | | | | | | | | | | | | | | | | | | | | | | | | | | | | | | | | | | | | | | | | | | | | | | | | | | | | | | | | | | | | | | | | | | | | | | | | | | | | | | | | | | | | | | | | | | | | | | | | | | | | | | | | | | | | | | | | | |
| 1/2 ss | | | | | | | | | | | | | | | | | | | | | | | | | | | | | | | | | | | | | | | | | | | | | | | | | | | | | | | | | | | | | | | | | | | | | | | | | | | | | | | | | | | | | | | | | | | | | | | | | | | | | | | | | | | | | | | | | | | | | | | | | | | | | | | | | | | | | | | | | | | | | | | | | | | | | | | | | | | | | | | | | | | | | | | | | | | | | | | | | | | | | | | | | | | | | | | | | | | | | | | | | | | | | | | | | | | | | | | | | | | | | | | | | | | | | | | | | | | | | | | | | | | | | | | | | | | | | | | | | | | | | | | | | | | | | | | | | | | | | | | | | | | | | | | | | | | | | | | | | | | | | | | | | | | | | | | | | | | | | | | | | | | | | | | | | | | | | | | | | | | | | | | | | | | | | | | | | | | | | | | | | | | | | | | | | | | | | | | | | | | | | | | | | | | | | | | | | | | | | | | | | | | | | | | | | | | | | | | | | | | | | | | | | | | | | | | | | | | | | | | | | | | | | | | | | | | | | | | | | | | | | | | | | | | | | | | | | | | | | | | | | | | | | | | | | | | | | | | | | | | | | | | | | | | | | | | | | | | | | | | | | | | | | | | | | | | | | | | | | | | | | | | | | | | | | | | | | | | | | | | | | | | | | | | | | | | | | | | | | | | | | | | | | | | | | | | | | | | | | | | | | | | | | | | | |
| 2 | 4 | 6 | 8 | 10 | | | | | | | | | | | | | | | | | | | | | | | | | | | | | | | | | | | | | | | | | | | | | | | | | | | | | | | | | | | | | | | | | | | | | | | | | | | | | | | | | | | | | | | | | | | | | | | | | | | | | | | | | | | | | | | | | | | | | | | | | | | | | | | | | | | | | | | | | | | | | | | | | | | | | | | | | | | | | | | | | | | | | | | | | | | | | | | | | | | | | | | | | | | | | | | | | | | | | | | | | | | | | | | | | | | | | | | | | | | | | | | | | | | | | | | | | | | | | | | | | | | | | | | | | | | | | | | | | | | | | | | | | | | | | | | | | | | | | | | | | | | | | | | | | | | | | | | | | | | | | | | | | | | | | | | | | | | | | | | | | | | | | | | | | | | | | | | | | | | | | | | | | | | | | | | | | | | | | | | | | | | | | | | | | | | | | | | | | | | | | | | | | | | | | | | | | | | | | | | | | | | | | | | | | | | | | | | | | | | | | | | | | | | | | | | | | | | | | | | | | | | | | | | | | | | | | | | | | | | | | | | | | | | | | | | | | | | | | | | | | | | | | | | | | | | | | | | | | | | | | | | | | | | | | | | | | | | | | | | | | | | | | | | | | | | | | | | | | | | | | | | | | | | | | | | | | | | | | | | | | | | | | | | | | | | | | | | | | | | | | | | | | | | | | | | | | | | | | | | | | | | | |
| 0.1 | 0.2 | 0.5 | 0.8 | 1.0 | | | | | | | | | | | | | | | | | | | | | | | | | | | | | | | | | | | | | | | | | | | | | | | | | | | | | | | | | | | | | | | | | | | | | | | | | | | | | | | | | | | | | | | | | | | | | | | | | | | | | | | | | | | | | | | | | | | | | | | | | | | | | | | | | | | | | | | | | | | | | | | | | | | | | | | | | | | | | | | | | | | | | | | | | | | | | | | | | | | | | | | | | | | | | | | | | | | | | | | | | | | | | | | | | | | | | | | | | | | | | | | | | | | | | | | | | | | | | | | | | | | | | | | | | | | | | | | | | | | | | | | | | | | | | | | | | | | | | | | | | | | | | | | | | | | | | | | | | | | | | | | | | | | | | | | | | | | | | | | | | | | | | | | | | | | | | | | | | | | | | | | | | | | | | | | | | | | | | | | | | | | | | | | | | | | | | | | | | | | | | | | | | | | | | | | | | | | | | | | | | | | | | | | | | | | | | | | | | | | | | | | | | | | | | | | | | | | | | | | | | | | | | | | | | | | | | | | | | | | | | | | | | | | | | | | | | | | | | | | | | | | | | | | | | | | | | | | | | | | | | | | | | | | | | | | | | | | | | | | | | | | | | | | | | | | | | | | | | | | | | | | | | | | | | | | | | | | | | | | | | | | | | | | | | | | | | | | | | | | | | | | | | | | | | | | | | | | | | | | | | | | | |
| 1/2 ss | | | | | | | | | | | | | | | | | | | | | | | | | | | | | | | | | | | | | | | | | | | | | | | | | | | | | | | | | | | | | | | | | | | | | | | | | | | | | | | | | | | | | | | | | | | | | | | | | | | | | | | | | | | | | | | | | | | | | | | | | | | | | | | | | | | | | | | | | | | | | | | | | | | | | | | | | | | | | | | | | | | | | | | | | | | | | | | | | | | | | | | | | | | | | | | | | | | | | | | | | | | | | | | | | | | | | | | | | | | | | | | | | | | | | | | | | | | | | | | | | | | | | | | | | | | | | | | | | | | | | | | | | | | | | | | | | | | | | | | | | | | | | | | | | | | | | | | | | | | | | | | | | | | | | | | | | | | | | | | | | | | | | | | | | | | | | | | | | | | | | | | | | | | | | | | | | | | | | | | | | | | | | | | | | | | | | | | | | | | | | | | | | | | | | | | | | | | | | | | | | | | | | | | | | | | | | | | | | | | | | | | | | | | | | | | | | | | | | | | | | | | | | | | | | | | | | | | | | | | | | | | | | | | | | | | | | | | | | | | | | | | | | | | | | | | | | | | | | | | | | | | | | | | | | | | | | | | | | | | | | | | | | | | | | | | | | | | | | | | | | | | | | | | | | | | | | | | | | | | | | | | | | | | | | | | | | | | | | | | | | | | | | | | | | | | | | | | | | | | | | | | | | | | | |
| 2 | 4 | 6 | 8 | 10 | | | | | | | | | | | | | | | | | | | | | | | | | | | | | | | | | | | | | | | | | | | | | | | | | | | | | | | | | | | | | | | | | | | | | | | | | | | | | | | | | | | | | | | | | | | | | | | | | | | | | | | | | | | | | | | | | | | | | | | | | | | | | | | | | | | | | | | | | | | | | | | | | | | | | | | | | | | | | | | | | | | | | | | | | | | | | | | | | | | | | | | | | | | | | | | | | | | | | | | | | | | | | | | | | | | | | | | | | | | | | | | | | | | | | | | | | | | | | | | | | | | | | | | | | | | | | | | | | | | | | | | | | | | | | | | | | | | | | | | | | | | | | | | | | | | | | | | | | | | | | | | | | | | | | | | | | | | | | | | | | | | | | | | | | | | | | | | | | | | | | | | | | | | | | | | | | | | | | | | | | | | | | | | | | | | | | | | | | | | | | | | | | | | | | | | | | | | | | | | | | | | | | | | | | | | | | | | | | | | | | | | | | | | | | | | | | | | | | | | | | | | | | | | | | | | | | | | | | | | | | | | | | | | | | | | | | | | | | | | | | | | | | | | | | | | | | | | | | | | | | | | | | | | | | | | | | | | | | | | | | | | | | | | | | | | | | | | | | | | | | | | | | | | | | | | | | | | | | | | | | | | | | | | | | | | | | | | | | | | | | | | | | | | | | | | | | | | | | | | | | | | | |
| 2.4 | 2.7 | 3.2 | 4.2 | 5.7 | | | | | | | | | | | | | | | | | | | | | | | | | | | | | | | | | | | | | | | | | | | | | | | | | | | | | | | | | | | | | | | | | | | | | | | | | | | | | | | | | | | | | | | | | | | | | | | | | | | | | | | | | | | | | | | | | | | | | | | | | | | | | | | | | | | | | | | | | | | | | | | | | | | | | | | | | | | | | | | | | | | | | | | | | | | | | | | | | | | | | | | | | | | | | | | | | | | | | | | | | | | | | | | | | | | | | | | | | | | | | | | | | | | | | | | | | | | | | | | | | | | | | | | | | | | | | | | | | | | | | | | | | | | | | | | | | | | | | | | | | | | | | | | | | | | | | | | | | | | | | | | | | | | | | | | | | | | | | | | | | | | | | | | | | | | | | | | | | | | | | | | | | | | | | | | | | | | | | | | | | | | | | | | | | | | | | | | | | | | | | | | | | | | | | | | | | | | | | | | | | | | | | | | | | | | | | | | | | | | | | | | | | | | | | | | | | | | | | | | | | | | | | | | | | | | | | | | | | | | | | | | | | | | | | | | | | | | | | | | | | | | | | | | | | | | | | | | | | | | | | | | | | | | | | | | | | | | | | | | | | | | | | | | | | | | | | | | | | | | | | | | | | | | | | | | | | | | | | | | | | | | | | | | | | | | | | | | | | | | | | | | | | | | | | | | | | | | | | | | | | | | | |
| 1/2 ss | | | | | | | | | | | | | | | | | | | | | | | | | | | | | | | | | | | | | | | | | | | | | | | | | | | | | | | | | | | | | | | | | | | | | | | | | | | | | | | | | | | | | | | | | | | | | | | | | | | | | | | | | | | | | | | | | | | | | | | | | | | | | | | | | | | | | | | | | | | | | | | | | | | | | | | | | | | | | | | | | | | | | | | | | | | | | | | | | | | | | | | | | | | | | | | | | | | | | | | | | | | | | | | | | | | | | | | | | | | | | | | | | | | | | | | | | | | | | | | | | | | | | | | | | | | | | | | | | | | | | | | | | | | | | | | | | | | | | | | | | | | | | | | | | | | | | | | | | | | | | | | | | | | | | | | | | | | | | | | | | | | | | | | | | | | | | | | | | | | | | | | | | | | | | | | | | | | | | | | | | | | | | | | | | | | | | | | | | | | | | | | | | | | | | | | | | | | | | | | | | | | | | | | | | | | | | | | | | | | | | | | | | | | | | | | | | | | | | | | | | | | | | | | | | | | | | | | | | | | | | | | | | | | | | | | | | | | | | | | | | | | | | | | | | | | | | | | | | | | | | | | | | | | | | | | | | | | | | | | | | | | | | | | | | | | | | | | | | | | | | | | | | | | | | | | | | | | | | | | | | | | | | | | | | | | | | | | | | | | | | | | | | | | | | | | | | | | | | | | | | | | | | | | | |
| 2 | 4 | 6 | 8 | 10 | | | | | | | | | | | | | | | | | | | | | | | | | | | | | | | | | | | | | | | | | | | | | | | | | | | | | | | | | | | | | | | | | | | | | | | | | | | | | | | | | | | | | | | | | | | | | | | | | | | | | | | | | | | | | | | | | | | | | | | | | | | | | | | | | | | | | | | | | | | | | | | | | | | | | | | | | | | | | | | | | | | | | | | | | | | | | | | | | | | | | | | | | | | | | | | | | | | | | | | | | | | | | | | | | | | | | | | | | | | | | | | | | | | | | | | | | | | | | | | | | | | | | | | | | | | | | | | | | | | | | | | | | | | | | | | | | | | | | | | | | | | | | | | | | | | | | | | | | | | | | | | | | | | | | | | | | | | | | | | | | | | | | | | | | | | | | | | | | | | | | | | | | | | | | | | | | | | | | | | | | | | | | | | | | | | | | | | | | | | | | | | | | | | | | | | | | | | | | | | | | | | | | | | | | | | | | | | | | | | | | | | | | | | | | | | | | | | | | | | | | | | | | | | | | | | | | | | | | | | | | | | | | | | | | | | | | | | | | | | | | | | | | | | | | | | | | | | | | | | | | | | | | | | | | | | | | | | | | | | | | | | | | | | | | | | | | | | | | | | | | | | | | | | | | | | | | | | | | | | | | | | | | | | | | | | | | | | | | | | | | | | | | | | | | | | | | | | | | | | | | | | | |
| 0.2 | 0.4 | 0.6 | 0.8 | 1.0 | | | | | | | | | | | | | | | | | | | | | | | | | | | | | | | | | | | | | | | | | | | | | | | | | | | | | | | | | | | | | | | | | | | | | | | | | | | | | | | | | | | | | | | | | | | | | | | | | | | | | | | | | | | | | | | | | | | | | | | | | | | | | | | | | | | | | | | | | | | | | | | | | | | | | | | | | | | | | | | | | | | | | | | | | | | | | | | | | | | | | | | | | | | | | | | | | | | | | | | | | | | | | | | | | | | | | | | | | | | | | | | | | | | | | | | | | | | | | | | | | | | | | | | | | | | | | | | | | | | | | | | | | | | | | | | | | | | | | | | | | | | | | | | | | | | | | | | | | | | | | | | | | | | | | | | | | | | | | | | | | | | | | | | | | | | | | | | | | | | | | | | | | | | | | | | | | | | | | | | | | | | | | | | | | | | | | | | | | | | | | | | | | | | | | | | | | | | | | | | | | | | | | | | | | | | | | | | | | | | | | | | | | | | | | | | | | | | | | | | | | | | | | | | | | | | | | | | | | | | | | | | | | | | | | | | | | | | | | | | | | | | | | | | | | | | | | | | | | | | | | | | | | | | | | | | | | | | | | | | | | | | | | | | | | | | | | | | | | | | | | | | | | | | | | | | | | | | | | | | | | | | | | | | | | | | | | | | | | | | | | | | | | | | | | | | | | | | | | | | | | | | | |
| 1/2 ss | | | | | | | | | | | | | | | | | | | | | | | | | | | | | | | | | | | | | | | | | | | | | | | | | | | | | | | | | | | | | | | | | | | | | | | | | | | | | | | | | | | | | | | | | | | | | | | | | | | | | | | | | | | | | | | | | | | | | | | | | | | | | | | | | | | | | | | | | | | | | | | | | | | | | | | | | | | | | | | | | | | | | | | | | | | | | | | | | | | | | | | | | | | | | | | | | | | | | | | | | | | | | | | | | | | | | | | | | | | | | | | | | | | | | | | | | | | | | | | | | | | | | | | | | | | | | | | | | | | | | | | | | | | | | | | | | | | | | | | | | | | | | | | | | | | | | | | | | | | | | | | | | | | | | | | | | | | | | | | | | | | | | | | | | | | | | | | | | | | | | | | | | | | | | | | | | | | | | | | | | | | | | | | | | | | | | | | | | | | | | | | | | | | | | | | | | | | | | | | | | | | | | | | | | | | | | | | | | | | | | | | | | | | | | | | | | | | | | | | | | | | | | | | | | | | | | | | | | | | | | | | | | | | | | | | | | | | | | | | | | | | | | | | | | | | | | | | | | | | | | | | | | | | | | | | | | | | | | | | | | | | | | | | | | | | | | | | | | | | | | | | | | | | | | | | | | | | | | | | | | | | | | | | | | | | | | | | | | | | | | | | | | | | | | | | | | | | | | | | | | | | | | | | | |
| 2 | 4 | 6 | 8 | 10 | | | | | | | | | | | | | | | | | | | | | | | | | | | | | | | | | | | | | | | | | | | | | | | | | | | | | | | | | | | | | | | | | | | | | | | | | | | | | | | | | | | | | | | | | | | | | | | | | | | | | | | | | | | | | | | | | | | | | | | | | | | | | | | | | | | | | | | | | | | | | | | | | | | | | | | | | | | | | | | | | | | | | | | | | | | | | | | | | | | | | | | | | | | | | | | | | | | | | | | | | | | | | | | | | | | | | | | | | | | | | | | | | | | | | | | | | | | | | | | | | | | | | | | | | | | | | | | | | | | | | | | | | | | | | | | | | | | | | | | | | | | | | | | | | | | | | | | | | | | | | | | | | | | | | | | | | | | | | | | | | | | | | | | | | | | | | | | | | | | | | | | | | | | | | | | | | | | | | | | | | | | | | | | | | | | | | | | | | | | | | | | | | | | | | | | | | | | | | | | | | | | | | | | | | | | | | | | | | | | | | | | | | | | | | | | | | | | | | | | | | | | | | | | | | | | | | | | | | | | | | | | | | | | | | | | | | | | | | | | | | | | | | | | | | | | | | | | | | | | | | | | | | | | | | | | | | | | | | | | | | | | | | | | | | | | | | | | | | | | | | | | | | | | | | | | | | | | | | | | | | | | | | | | | | | | | | | | | | | | | | | | | | | | | | | | | | | | | | | | | | | | | |
| 1 | 0.1 | 0.2 | 0.4 | 0.7 | | | | | | | | | | | | | | | | | | | | | | | | | | | | | | | | | | | | | | | | | | | | | | | | | | | | | | | | | | | | | | | | | | | | | | | | | | | | | | | | | | | | | | | | | | | | | | | | | | | | | | | | | | | | | | | | | | | | | | | | | | | | | | | | | | | | | | | | | | | | | | | | | | | | | | | | | | | | | | | | | | | | | | | | | | | | | | | | | | | | | | | | | | | | | | | | | | | | | | | | | | | | | | | | | | | | | | | | | | | | | | | | | | | | | | | | | | | | | | | | | | | | | | | | | | | | | | | | | | | | | | | | | | | | | | | | | | | | | | | | | | | | | | | | | | | | | | | | | | | | | | | | | | | | | | | | | | | | | | | | | | | | | | | | | | | | | | | | | | | | | | | | | | | | | | | | | | | | | | | | | | | | | | | | | | | | | | | | | | | | | | | | | | | | | | | | | | | | | | | | | | | | | | | | | | | | | | | | | | | | | | | | | | | | | | | | | | | | | | | | | | | | | | | | | | | | | | | | | | | | | | | | | | | | | | | | | | | | | | | | | | | | | | | | | | | | | | | | | | | | | | | | | | | | | | | | | | | | | | | | | | | | | | | | | | | | | | | | | | | | | | | | | | | | | | | | | | | | | | | | | | | | | | | | | | | | | | | | | | | | | | | | | | | | | | | | | | | | | | | | | | | | |
| 3 | 0.6 | 1.0 | 1.5 | 2.0 | | | | | | | | | | | | | | | | | | | | | | | | | | | | | | | | | | | | | | | | | | | | | | | | | | | | | | | | | | | | | | | | | | | | | | | | | | | | | | | | | | | | | | | | | | | | | | | | | | | | | | | | | | | | | | | | | | | | | | | | | | | | | | | | | | | | | | | | | | | | | | | | | | | | | | | | | | | | | | | | | | | | | | | | | | | | | | | | | | | | | | | | | | | | | | | | | | | | | | | | | | | | | | | | | | | | | | | | | | | | | | | | | | | | | | | | | | | | | | | | | | | | | | | | | | | | | | | | | | | | | | | | | | | | | | | | | | | | | | | | | | | | | | | | | | | | | | | | | | | | | | | | | | | | | | | | | | | | | | | | | | | | | | | | | | | | | | | | | | | | | | | | | | | | | | | | | | | | | | | | | | | | | | | | | | | | | | | | | | | | | | | | | | | | | | | | | | | | | | | | | | | | | | | | | | | | | | | | | | | | | | | | | | | | | | | | | | | | | | | | | | | | | | | | | | | | | | | | | | | | | | | | | | | | | | | | | | | | | | | | | | | | | | | | | | | | | | | | | | | | | | | | | | | | | | | | | | | | | | | | | | | | | | | | | | | | | | | | | | | | | | | | | | | | | | | | | | | | | | | | | | | | | | | | | | | | | | | | | | | | | | | | | | | | | | | | | | | | | | | | | | | | |
| 5 | 1.1 | 1.7 | 2.2 | 2.7 | | | | | | | | | | | | | | | | | | | | | | | | | | | | | | | | | | | | | | | | | | | | | | | | | | | | | | | | | | | | | | | | | | | | | | | | | | | | | | | | | | | | | | | | | | | | | | | | | | | | | | | | | | | | | | | | | | | | | | | | | | | | | | | | | | | | | | | | | | | | | | | | | | | | | | | | | | | | | | | | | | | | | | | | | | | | | | | | | | | | | | | | | | | | | | | | | | | | | | | | | | | | | | | | | | | | | | | | | | | | | | | | | | | | | | | | | | | | | | | | | | | | | | | | | | | | | | | | | | | | | | | | | | | | | | | | | | | | | | | | | | | | | | | | | | | | | | | | | | | | | | | | | | | | | | | | | | | | | | | | | | | | | | | | | | | | | | | | | | | | | | | | | | | | | | | | | | | | | | | | | | | | | | | | | | | | | | | | | | | | | | | | | | | | | | | | | | | | | | | | | | | | | | | | | | | | | | | | | | | | | | | | | | | | | | | | | | | | | | | | | | | | | | | | | | | | | | | | | | | | | | | | | | | | | | | | | | | | | | | | | | | | | | | | | | | | | | | | | | | | | | | | | | | | | | | | | | | | | | | | | | | | | | | | | | | | | | | | | | | | | | | | | | | | | | | | | | | | | | | | | | | | | | | | | | | | | | | | | | | | | | | | | | | | | | | | | | | | | | | | | | | | |
| 7 | 1.6 | 2.2 | 2.8 | 3.4 | | | | | | | | | | | | | | | | | | | | | | | | | | | | | | | | | | | | | | | | | | | | | | | | | | | | | | | | | | | | | | | | | | | | | | | | | | | | | | | | | | | | | | | | | | | | | | | | | | | | | | | | | | | | | | | | | | | | | | | | | | | | | | | | | | | | | | | | | | | | | | | | | | | | | | | | | | | | | | | | | | | | | | | | | | | | | | | | | | | | | | | | | | | | | | | | | | | | | | | | | | | | | | | | | | | | | | | | | | | | | | | | | | | | | | | | | | | | | | | | | | | | | | | | | | | | | | | | | | | | | | | | | | | | | | | | | | | | | | | | | | | | | | | | | | | | | | | | | | | | | | | | | | | | | | | | | | | | | | | | | | | | | | | | | | | | | | | | | | | | | | | | | | | | | | | | | | | | | | | | | | | | | | | | | | | | | | | | | | | | | | | | | | | | | | | | | | | | | | | | | | | | | | | | | | | | | | | | | | | | | | | | | | | | | | | | | | | | | | | | | | | | | | | | | | | | | | | | | | | | | | | | | | | | | | | | | | | | | | | | | | | | | | | | | | | | | | | | | | | | | | | | | | | | | | | | | | | | | | | | | | | | | | | | | | | | | | | | | | | | | | | | | | | | | | | | | | | | | | | | | | | | | | | | | | | | | | | | | | | | | | | | | | | | | | | | | | | | | | | | | | | | |
| 1/2 ss | | | | | | | | | | | | | | | | | | | | | | | | | | | | | | | | | | | | | | | | | | | | | | | | | | | | | | | | | | | | | | | | | | | | | | | | | | | | | | | | | | | | | | | | | | | | | | | | | | | | | | | | | | | | | | | | | | | | | | | | | | | | | | | | | | | | | | | | | | | | | | | | | | | | | | | | | | | | | | | | | | | | | | | | | | | | | | | | | | | | | | | | | | | | | | | | | | | | | | | | | | | | | | | | | | | | | | | | | | | | | | | | | | | | | | | | | | | | | | | | | | | | | | | | | | | | | | | | | | | | | | | | | | | | | | | | | | | | | | | | | | | | | | | | | | | | | | | | | | | | | | | | | | | | | | | | | | | | | | | | | | | | | | | | | | | | | | | | | | | | | | | | | | | | | | | | | | | | | | | | | | | | | | | | | | | | | | | | | | | | | | | | | | | | | | | | | | | | | | | | | | | | | | | | | | | | | | | | | | | | | | | | | | | | | | | | | | | | | | | | | | | | | | | | | | | | | | | | | | | | | | | | | | | | | | | | | | | | | | | | | | | | | | | | | | | | | | | | | | | | | | | | | | | | | | | | | | | | | | | | | | | | | | | | | | | | | | | | | | | | | | | | | | | | | | | | | | | | | | | | | | | | | | | | | | | | | | | | | | | | | | | | | | | | | | | | | | | | | | | | | | | | | | | | |
| 2 | 4 | 6 | 8 | 10 | | | | | | | | | | | | | | | | | | | | | | | | | | | | | | | | | | | | | | | | | | | | | | | | | | | | | | | | | | | | | | | | | | | | | | | | | | | | | | | | | | | | | | | | | | | | | | | | | | | | | | | | | | | | | | | | | | | | | | | | | | | | | | | | | | | | | | | | | | | | | | | | | | | | | | | | | | | | | | | | | | | | | | | | | | | | | | | | | | | | | | | | | | | | | | | | | | | | | | | | | | | | | | | | | | | | | | | | | | | | | | | | | | | | | | | | | | | | | | | | | | | | | | | | | | | | | | | | | | | | | | | | | | | | | | | | | | | | | | | | | | | | | | | | | | | | | | | | | | | | | | | | | | | | | | | | | | | | | | | | | | | | | | | | | | | | | | | | | | | | | | | | | | | | | | | | | | | | | | | | | | | | | | | | | | | | | | | | | | | | | | | | | | | | | | | | | | | | | | | | | | | | | | | | | | | | | | | | | | | | | | | | | | | | | | | | | | | | | | | | | | | | | | | | | | | | | | | | | | | | | | | | | | | | | | | | | | | | | | | | | | | | | | | | | | | | | | | | | | | | | | | | | | | | | | | | | | | | | | | | | | | | | | | | | | | | | | | | | | | | | | | | | | | | | | | | | | | | | | | | | | | | | | | | | | | | | | | | | | | | | | | | | | | | | | | | | | | | | | | | | | | | |
| 1 | 1.0 | 1.5 | 2.0 | 2.5 | | | | | | | | | | | | | | | | | | | | | | | | | | | | | | | | | | | | | | | | | | | | | | | | | | | | | | | | | | | | | | | | | | | | | | | | | | | | | | | | | | | | | | | | | | | | | | | | | | | | | | | | | | | | | | | | | | | | | | | | | | | | | | | | | | | | | | | | | | | | | | | | | | | | | | | | | | | | | | | | | | | | | | | | | | | | | | | | | | | | | | | | | | | | | | | | | | | | | | | | | | | | | | | | | | | | | | | | | | | | | | | | | | | | | | | | | | | | | | | | | | | | | | | | | | | | | | | | | | | | | | | | | | | | | | | | | | | | | | | | | | | | | | | | | | | | | | | | | | | | | | | | | | | | | | | | | | | | | | | | | | | | | | | | | | | | | | | | | | | | | | | | | | | | | | | | | | | | | | | | | | | | | | | | | | | | | | | | | | | | | | | | | | | | | | | | | | | | | | | | | | | | | | | | | | | | | | | | | | | | | | | | | | | | | | | | | | | | | | | | | | | | | | | | | | | | | | | | | | | | | | | | | | | | | | | | | | | | | | | | | | | | | | | | | | | | | | | | | | | | | | | | | | | | | | | | | | | | | | | | | | | | | | | | | | | | | | | | | | | | | | | | | | | | | | | | | | | | | | | | | | | | | | | | | | | | | | | | | | | | | | | | | | | | | | | | | | | | | | | | | | | | |
| 4 | 1.6 | 2.3 | 3.0 | 3.7 | | | | | | | | | | | | | | | | | | | | | | | | | | | | | | | | | | | | | | | | | | | | | | | | | | | | | | | | | | | | | | | | | | | | | | | | | | | | | | | | | | | | | | | | | | | | | | | | | | | | | | | | | | | | | | | | | | | | | | | | | | | | | | | | | | | | | | | | | | | | | | | | | | | | | | | | | | | | | | | | | | | | | | | | | | | | | | | | | | | | | | | | | | | | | | | | | | | | | | | | | | | | | | | | | | | | | | | | | | | | | | | | | | | | | | | | | | | | | | | | | | | | | | | | | | | | | | | | | | | | | | | | | | | | | | | | | | | | | | | | | | | | | | | | | | | | | | | | | | | | | | | | | | | | | | | | | | | | | | | | | | | | | | | | | | | | | | | | | | | | | | | | | | | | | | | | | | | | | | | | | | | | | | | | | | | | | | | | | | | | | | | | | | | | | | | | | | | | | | | | | | | | | | | | | | | | | | | | | | | | | | | | | | | | | | | | | | | | | | | | | | | | | | | | | | | | | | | | | | | | | | | | | | | | | | | | | | | | | | | | | | | | | | | | | | | | | | | | | | | | | | | | | | | | | | | | | | | | | | | | | | | | | | | | | | | | | | | | | | | | | | | | | | | | | | | | | | | | | | | | | | | | | | | | | | | | | | | | | | | | | | | | | | | | | | | | | | | | | | | | | | | | |
| 6 | 2.3 | 3.0 | 3.7 | 4.4 | | | | | | | | | | | | | | | | | | | | | | | | | | | | | | | | | | | | | | | | | | | | | | | | | | | | | | | | | | | | | | | | | | | | | | | | | | | | | | | | | | | | | | | | | | | | | | | | | | | | | | | | | | | | | | | | | | | | | | | | | | | | | | | | | | | | | | | | | | | | | | | | | | | | | | | | | | | | | | | | | | | | | | | | | | | | | | | | | | | | | | | | | | | | | | | | | | | | | | | | | | | | | | | | | | | | | | | | | | | | | | | | | | | | | | | | | | | | | | | | | | | | | | | | | | | | | | | | | | | | | | | | | | | | | | | | | | | | | | | | | | | | | | | | | | | | | | | | | | | | | | | | | | | | | | | | | | | | | | | | | | | | | | | | | | | | | | | | | | | | | | | | | | | | | | | | | | | | | | | | | | | | | | | | | | | | | | | | | | | | | | | | | | | | | | | | | | | | | | | | | | | | | | | | | | | | | | | | | | | | | | | | | | | | | | | | | | | | | | | | | | | | | | | | | | | | | | | | | | | | | | | | | | | | | | | | | | | | | | | | | | | | | | | | | | | | | | | | | | | | | | | | | | | | | | | | | | | | | | | | | | | | | | | | | | | | | | | | | | | | | | | | | | | | | | | | | | | | | | | | | | | | | | | | | | | | | | | | | | | | | | | | | | | | | | | | | | | | | | | | | | | | |
| 1/2 ss | | | | | | | | | | | | | | | | | | | | | | | | | | | | | | | | | | | | | | | | | | | | | | | | | | | | | | | | | | | | | | | | | | | | | | | | | | | | | | | | | | | | | | | | | | | | | | | | | | | | | | | | | | | | | | | | | | | | | | | | | | | | | | | | | | | | | | | | | | | | | | | | | | | | | | | | | | | | | | | | | | | | | | | | | | | | | | | | | | | | | | | | | | | | | | | | | | | | | | | | | | | | | | | | | | | | | | | | | | | | | | | | | | | | | | | | | | | | | | | | | | | | | | | | | | | | | | | | | | | | | | | | | | | | | | | | | | | | | | | | | | | | | | | | | | | | | | | | | | | | | | | | | | | | | | | | | | | | | | | | | | | | | | | | | | | | | | | | | | | | | | | | | | | | | | | | | | | | | | | | | | | | | | | | | | | | | | | | | | | | | | | | | | | | | | | | | | | | | | | | | | | | | | | | | | | | | | | | | | | | | | | | | | | | | | | | | | | | | | | | | | | | | | | | | | | | | | | | | | | | | | | | | | | | | | | | | | | | | | | | | | | | | | | | | | | | | | | | | | | | | | | | | | | | | | | | | | | | | | | | | | | | | | | | | | | | | | | | | | | | | | | | | | | | | | | | | | | | | | | | | | | | | | | | | | | | | | | | | | | | | | | | | | | | | | | | | | | | | | | | | | | | | | | | |
| 2 | 4 | 6 | 8 | 10 | | | | | | | | | | | | | | | | | | | | | | | | | | | | | | | | | | | | | | | | | | | | | | | | | | | | | | | | | | | | | | | | | | | | | | | | | | | | | | | | | | | | | | | | | | | | | | | | | | | | | | | | | | | | | | | | | | | | | | | | | | | | | | | | | | | | | | | | | | | | | | | | | | | | | | | | | | | | | | | | | | | | | | | | | | | | | | | | | | | | | | | | | | | | | | | | | | | | | | | | | | | | | | | | | | | | | | | | | | | | | | | | | | | | | | | | | | | | | | | | | | | | | | | | | | | | | | | | | | | | | | | | | | | | | | | | | | | | | | | | | | | | | | | | | | | | | | | | | | | | | | | | | | | | | | | | | | | | | | | | | | | | | | | | | | | | | | | | | | | | | | | | | | | | | | | | | | | | | | | | | | | | | | | | | | | | | | | | | | | | | | | | | | | | | | | | | | | | | | | | | | | | | | | | | | | | | | | | | | | | | | | | | | | | | | | | | | | | | | | | | | | | | | | | | | | | | | | | | | | | | | | | | | | | | | | | | | | | | | | | | | | | | | | | | | | | | | | | | | | | | | | | | | | | | | | | | | | | | | | | | | | | | | | | | | | | | | | | | | | | | | | | | | | | | | | | | | | | | | | | | | | | | | | | | | | | | | | | | | | | | | | | | | | | | | | | | | | | | | | | | | | | |
| 0.4 | 0.6 | 0.9 | 1.4 | 2.0 | | | | | | | | | | | | | | | | | | | | | | | | | | | | | | | | | | | | | | | | | | | | | | | | | | | | | | | | | | | | | | | | | | | | | | | | | | | | | | | | | | | | | | | | | | | | | | | | | | | | | | | | | | | | | | | | | | | | | | | | | | | | | | | | | | | | | | | | | | | | | | | | | | | | | | | | | | | | | | | | | | | | | | | | | | | | | | | | | | | | | | | | | | | | | | | | | | | | | | | | | | | | | | | | | | | | | | | | | | | | | | | | | | | | | | | | | | | | | | | | | | | | | | | | | | | | | | | | | | | | | | | | | | | | | | | | | | | | | | | | | | | | | | | | | | | | | | | | | | | | | | | | | | | | | | | | | | | | | | | | | | | | | | | | | | | | | | | | | | | | | | | | | | | | | | | | | | | | | | | | | | | | | | | | | | | | | | | | | | | | | | | | | | | | | | | | | | | | | | | | | | | | | | | | | | | | | | | | | | | | | | | | | | | | | | | | | | | | | | | | | | | | | | | | | | | | | | | | | | | | | | | | | | | | | | | | | | | | | | | | | | | | | | | | | | | | | | | | | | | | | | | | | | | | | | | | | | | | | | | | | | | | | | | | | | | | | | | | | | | | | | | | | | | | | | | | | | | | | | | | | | | | | | | | | | | | | | | | | | | | | | | | | | | | | | | | | | | | | | | | | | | | |
| 1/2 ss | | | | | | | | | | | | | | | | | | | | | | | | | | | | | | | | | | | | | | | | | | | | | | | | | | | | | | | | | | | | | | | | | | | | | | | | | | | | | | | | | | | | | | | | | | | | | | | | | | | | | | | | | | | | | | | | | | | | | | | | | | | | | | | | | | | | | | | | | | | | | | | | | | | | | | | | | | | | | | | | | | | | | | | | | | | | | | | | | | | | | | | | | | | | | | | | | | | | | | | | | | | | | | | | | | | | | | | | | | | | | | | | | | | | | | | | | | | | | | | | | | | | | | | | | | | | | | | | | | | | | | | | | | | | | | | | | | | | | | | | | | | | | | | | | | | | | | | | | | | | | | | | | | | | | | | | | | | | | | | | | | | | | | | | | | | | | | | | | | | | | | | | | | | | | | | | | | | | | | | | | | | | | | | | | | | | | | | | | | | | | | | | | | | | | | | | | | | | | | | | | | | | | | | | | | | | | | | | | | | | | | | | | | | | | | | | | | | | | | | | | | | | | | | | | | | | | | | | | | | | | | | | | | | | | | | | | | | | | | | | | | | | | | | | | | | | | | | | | | | | | | | | | | | | | | | | | | | | | | | | | | | | | | | | | | | | | | | | | | | | | | | | | | | | | | | | | | | | | | | | | | | | | | | | | | | | | | | | | | | | | | | | | | | | | | | | | | | | | | | | | | | | | | | | |
| 2 | 4 | 6 | 8 | 10 | | | | | | | | | | | | | | | | | | | | | | | | | | | | | | | | | | | | | | | | | | | | | | | | | | | | | | | | | | | | | | | | | | | | | | | | | | | | | | | | | | | | | | | | | | | | | | | | | | | | | | | | | | | | | | | | | | | | | | | | | | | | | | | | | | | | | | | | | | | | | | | | | | | | | | | | | | | | | | | | | | | | | | | | | | | | | | | | | | | | | | | | | | | | | | | | | | | | | | | | | | | | | | | | | | | | | | | | | | | | | | | | | | | | | | | | | | | | | | | | | | | | | | | | | | | | | | | | | | | | | | | | | | | | | | | | | | | | | | | | | | | | | | | | | | | | | | | | | | | | | | | | | | | | | | | | | | | | | | | | | | | | | | | | | | | | | | | | | | | | | | | | | | | | | | | | | | | | | | | | | | | | | | | | | | | | | | | | | | | | | | | | | | | | | | | | | | | | | | | | | | | | | | | | | | | | | | | | | | | | | | | | | | | | | | | | | | | | | | | | | | | | | | | | | | | | | | | | | | | | | | | | | | | | | | | | | | | | | | | | | | | | | | | | | | | | | | | | | | | | | | | | | | | | | | | | | | | | | | | | | | | | | | | | | | | | | | | | | | | | | | | | | | | | | | | | | | | | | | | | | | | | | | | | | | | | | | | | | | | | | | | | | | | | | | | | | | | | | | | | | | | | |
| 2.4 | 2.7 | 3.2 | 4.2 | 5.7 | | | | | | | | | | | | | | | | | | | | | | | | | | | | | | | | | | | | | | | | | | | | | | | | | | | | | | | | | | | | | | | | | | | | | | | | | | | | | | | | | | | | | | | | | | | | | | | | | | | | | | | | | | | | | | | | | | | | | | | | | | | | | | | | | | | | | | | | | | | | | | | | | | | | | | | | | | | | | | | | | | | | | | | | | | | | | | | | | | | | | | | | | | | | | | | | | | | | | | | | | | | | | | | | | | | | | | | | | | | | | | | | | | | | | | | | | | | | | | | | | | | | | | | | | | | | | | | | | | | | | | | | | | | | | | | | | | | | | | | | | | | | | | | | | | | | | | | | | | | | | | | | | | | | | | | | | | | | | | | | | | | | | | | | | | | | | | | | | | | | | | | | | | | | | | | | | | | | | | | | | | | | | | | | | | | | | | | | | | | | | | | | | | | | | | | | | | | | | | | | | | | | | | | | | | | | | | | | | | | | | | | | | | | | | | | | | | | | | | | | | | | | | | | | | | | | | | | | | | | | | | | | | | | | | | | | | | | | | | | | | | | | | | | | | | | | | | | | | | | | | | | | | | | | | | | | | | | | | | | | | | | | | | | | | | | | | | | | | | | | | | | | | | | | | | | | | | | | | | | | | | | | | | | | | | | | | | | | | | | | | | | | | | | | | | | | | | | | | | | | | | | | |
| 1/2 ss | | | | | | | | | | | | | | | | | | | | | | | | | | | | | | | | | | | | | | | | | | | | | | | | | | | | | | | | | | | | | | | | | | | | | | | | | | | | | | | | | | | | | | | | | | | | | | | | | | | | | | | | | | | | | | | | | | | | | | | | | | | | | | | | | | | | | | | | | | | | | | | | | | | | | | | | | | | | | | | | | | | | | | | | | | | | | | | | | | | | | | | | | | | | | | | | | | | | | | | | | | | | | | | | | | | | | | | | | | | | | | | | | | | | | | | | | | | | | | | | | | | | | | | | | | | | | | | | | | | | | | | | | | | | | | | | | | | | | | | | | | | | | | | | | | | | | | | | | | | | | | | | | | | | | | | | | | | | | | | | | | | | | | | | | | | | | | | | | | | | | | | | | | | | | | | | | | | | | | | | | | | | | | | | | | | | | | | | | | | | | | | | | | | | | | | | | | | | | | | | | | | | | | | | | | | | | | | | | | | | | | | | | | | | | | | | | | | | | | | | | | | | | | | | | | | | | | | | | | | | | | | | | | | | | | | | | | | | | | | | | | | | | | | | | | | | | | | | | | | | | | | | | | | | | | | | | | | | | | | | | | | | | | | | | | | | | | | | | | | | | | | | | | | | | | | | | | | | | | | | | | | | | | | | | | | | | | | | | | | | | | | | | | | | | | | | | | | | | | | | | | | | | | | | |
| 2 | 4 | 6 | 8 | 10 | | | | | | | | | | | | | | | | | | | | | | | | | | | | | | | | | | | | | | | | | | | | | | | | | | | | | | | | | | | | | | | | | | | | | | | | | | | | | | | | | | | | | | | | | | | | | | | | | | | | | | | | | | | | | | | | | | | | | | | | | | | | | | | | | | | | | | | | | | | | | | | | | | | | | | | | | | | | | | | | | | | | | | | | | | | | | | | | | | | | | | | | | | | | | | | | | | | | | | | | | | | | | | | | | | | | | | | | | | | | | | | | | | | | | | | | | | | | | | | | | | | | | | | | | | | | | | | | | | | | | | | | | | | | | | | | | | | | | | | | | | | | | | | | | | | | | | | | | | | | | | | | | | | | | | | | | | | | | | | | | | | | | | | | | | | | | | | | | | | | | | | | | | | | | | | | | | | | | | | | | | | | | | | | | | | | | | | | | | | | | | | | | | | | | | | | | | | | | | | | | | | | | | | | | | | | | | | | | | | | | | | | | | | | | | | | | | | | | | | | | | | | | | | | | | | | | | | | | | | | | | | | | | | | | | | | | | | | | | | | | | | | | | | | | | | | | | | | | | | | | | | | | | | | | | | | | | | | | | | | | | | | | | | | | | | | | | | | | | | | | | | | | | | | | | | | | | | | | | | | | | | | | | | | | | | | | | | | | | | | | | | | | | | | | | | | | | | | | | | | | | | | |
| 0.2 | 0.3 | 0.5 | 0.7 | 0.9 | | | | | | | | | | | | | | | | | | | | | | | | | | | | | | | | | | | | | | | | | | | | | | | | | | | | | | | | | | | | | | | | | | | | | | | | | | | | | | | | | | | | | | | | | | | | | | | | | | | | | | | | | | | | | | | | | | | | | | | | | | | | | | | | | | | | | | | | | | | | | | | | | | | | | | | | | | | | | | | | | | | | | | | | | | | | | | | | | | | | | | | | | | | | | | | | | | | | | | | | | | | | | | | | | | | | | | | | | | | | | | | | | | | | | | | | | | | | | | | | | | | | | | | | | | | | | | | | | | | | | | | | | | | | | | | | | | | | | | | | | | | | | | | | | | | | | | | | | | | | | | | | | | | | | | | | | | | | | | | | | | | | | | | | | | | | | | | | | | | | | | | | | | | | | | | | | | | | | | | | | | | | | | | | | | | | | | | | | | | | | | | | | | | | | | | | | | | | | | | | | | | | | | | | | | | | | | | | | | | | | | | | | | | | | | | | | | | | | | | | | | | | | | | | | | | | | | | | | | | | | | | | | | | | | | | | | | | | | | | | | | | | | | | | | | | | | | | | | | | | | | | | | | | | | | | | | | | | | | | | | | | | | | | | | | | | | | | | | | | | | | | | | | | | | | | | | | | | | | | | | | | | | | | | | | | | | | | | | | | | | | | | | | | | | | | | | | | | | | | | | | | | |
| 1/2 ss | | | | | | | | | | | | | | | | | | | | | | | | | | | | | | | | | | | | | | | | | | | | | | | | | | | | | | | | | | | | | | | | | | | | | | | | | | | | | | | | | | | | | | | | | | | | | | | | | | | | | | | | | | | | | | | | | | | | | | | | | | | | | | | | | | | | | | | | | | | | | | | | | | | | | | | | | | | | | | | | | | | | | | | | | | | | | | | | | | | | | | | | | | | | | | | | | | | | | | | | | | | | | | | | | | | | | | | | | | | | | | | | | | | | | | | | | | | | | | | | | | | | | | | | | | | | | | | | | | | | | | | | | | | | | | | | | | | | | | | | | | | | | | | | | | | | | | | | | | | | | | | | | | | | | | | | | | | | | | | | | | | | | | | | | | | | | | | | | | | | | | | | | | | | | | | | | | | | | | | | | | | | | | | | | | | | | | | | | | | | | | | | | | | | | | | | | | | | | | | | | | | | | | | | | | | | | | | | | | | | | | | | | | | | | | | | | | | | | | | | | | | | | | | | | | | | | | | | | | | | | | | | | | | | | | | | | | | | | | | | | | | | | | | | | | | | | | | | | | | | | | | | | | | | | | | | | | | | | | | | | | | | | | | | | | | | | | | | | | | | | | | | | | | | | | | | | | | | | | | | | | | | | | | | | | | | | | | | | | | | | | | | | | | | | | | | | | | | | | | | | | | | | | | | |
| 2 | 4 | 6 | 8 | 10 | | | | | | | | | | | | | | | | | | | | | | | | | | | | | | | | | | | | | | | | | | | | | | | | | | | | | | | | | | | | | | | | | | | | | | | | | | | | | | | | | | | | | | | | | | | | | | | | | | | | | | | | | | | | | | | | | | | | | | | | | | | | | | | | | | | | | | | | | | | | | | | | | | | | | | | | | | | | | | | | | | | | | | | | | | | | | | | | | | | | | | | | | | | | | | | | | | | | | | | | | | | | | | | | | | | | | | | | | | | | | | | | | | | | | | | | | | | | | | | | | | | | | | | | | | | | | | | | | | | | | | | | | | | | | | | | | | | | | | | | | | | | | | | | | | | | | | | | | | | | | | | | | | | | | | | | | | | | | | | | | | | | | | | | | | | | | | | | | | | | | | | | | | | | | | | | | | | | | | | | | | | | | | | | | | | | | | | | | | | | | | | | | | | | | | | | | | | | | | | | | | | | | | | | | | | | | | | | | | | | | | | | | | | | | | | | | | | | | | | | | | | | | | | | | | | | | | | | | | | | | | | | | | | | | | | | | | | | | | | | | | | | | | | | | | | | | | | | | | | | | | | | | | | | | | | | | | | | | | | | | | | | | | | | | | | | | | | | | | | | | | | | | | | | | | | | | | | | | | | | | | | | | | | | | | | | | | | | | | | | | | | | | | | | | | | | | | | | | | | | | | | | |
| 2 | 0.2 | 0.3 | 0.4 | 0.6 | | | | | | | | | | | | | | | | | | | | | | | | | | | | | | | | | | | | | | | | | | | | | | | | | | | | | | | | | | | | | | | | | | | | | | | | | | | | | | | | | | | | | | | | | | | | | | | | | | | | | | | | | | | | | | | | | | | | | | | | | | | | | | | | | | | | | | | | | | | | | | | | | | | | | | | | | | | | | | | | | | | | | | | | | | | | | | | | | | | | | | | | | | | | | | | | | | | | | | | | | | | | | | | | | | | | | | | | | | | | | | | | | | | | | | | | | | | | | | | | | | | | | | | | | | | | | | | | | | | | | | | | | | | | | | | | | | | | | | | | | | | | | | | | | | | | | | | | | | | | | | | | | | | | | | | | | | | | | | | | | | | | | | | | | | | | | | | | | | | | | | | | | | | | | | | | | | | | | | | | | | | | | | | | | | | | | | | | | | | | | | | | | | | | | | | | | | | | | | | | | | | | | | | | | | | | | | | | | | | | | | | | | | | | | | | | | | | | | | | | | | | | | | | | | | | | | | | | | | | | | | | | | | | | | | | | | | | | | | | | | | | | | | | | | | | | | | | | | | | | | | | | | | | | | | | | | | | | | | | | | | | | | | | | | | | | | | | | | | | | | | | | | | | | | | | | | | | | | | | | | | | | | | | | | | | | | | | | | | | | | | | | | | | | | | | | | | | | | | | | | | | | |
| 4 | 0.7 | 1.1 | 1.6 | 2.1 | | | | | | | | | | | | | | | | | | | | | | | | | | | | | | | | | | | | | | | | | | | | | | | | | | | | | | | | | | | | | | | | | | | | | | | | | | | | | | | | | | | | | | | | | | | | | | | | | | | | | | | | | | | | | | | | | | | | | | | | | | | | | | | | | | | | | | | | | | | | | | | | | | | | | | | | | | | | | | | | | | | | | | | | | | | | | | | | | | | | | | | | | | | | | | | | | | | | | | | | | | | | | | | | | | | | | | | | | | | | | | | | | | | | | | | | | | | | | | | | | | | | | | | | | | | | | | | | | | | | | | | | | | | | | | | | | | | | | | | | | | | | | | | | | | | | | | | | | | | | | | | | | | | | | | | | | | | | | | | | | | | | | | | | | | | | | | | | | | | | | | | | | | | | | | | | | | | | | | | | | | | | | | | | | | | | | | | | | | | | | | | | | | | | | | | | | | | | | | | | | | | | | | | | | | | | | | | | | | | | | | | | | | | | | | | | | | | | | | | | | | | | | | | | | | | | | | | | | | | | | | | | | | | | | | | | | | | | | | | | | | | | | | | | | | | | | | | | | | | | | | | | | | | | | | | | | | | | | | | | | | | | | | | | | | | | | | | | | | | | | | | | | | | | | | | | | | | | | | | | | | | | | | | | | | | | | | | | | | | | | | | | | | | | | | | | | | | | | | | | | | | | |
| 6 | 1.2 | 1.7 | 2.2 | 2.7 | | | | | | | | | | | | | | | | | | | | | | | | | | | | | | | | | | | | | | | | | | | | | | | | | | | | | | | | | | | | | | | | | | | | | | | | | | | | | | | | | | | | | | | | | | | | | | | | | | | | | | | | | | | | | | | | | | | | | | | | | | | | | | | | | | | | | | | | | | | | | | | | | | | | | | | | | | | | | | | | | | | | | | | | | | | | | | | | | | | | | | | | | | | | | | | | | | | | | | | | | | | | | | | | | | | | | | | | | | | | | | | | | | | | | | | | | | | | | | | | | | | | | | | | | | | | | | | | | | | | | | | | | | | | | | | | | | | | | | | | | | | | | | | | | | | | | | | | | | | | | | | | | | | | | | | | | | | | | | | | | | | | | | | | | | | | | | | | | | | | | | | | | | | | | | | | | | | | | | | | | | | | | | | | | | | | | | | | | | | | | | | | | | | | | | | | | | | | | | | | | | | | | | | | | | | | | | | | | | | | | | | | | | | | | | | | | | | | | | | | | | | | | | | | | | | | | | | | | | | | | | | | | | | | | | | | | | | | | | | | | | | | | | | | | | | | | | | | | | | | | | | | | | | | | | | | | | | | | | | | | | | | | | | | | | | | | | | | | | | | | | | | | | | | | | | | | | | | | | | | | | | | | | | | | | | | | | | | | | | | | | | | | | | | | | | | | | | | | | | | | | | | |
| 8 | 1.7 | 2.2 | 2.7 | 3.2 | | | | | | | | | | | | | | | | | | | | | | | | | | | | | | | | | | | | | | | | | | | | | | | | | | | | | | | | | | | | | | | | | | | | | | | | | | | | | | | | | | | | | | | | | | | | | | | | | | | | | | | | | | | | | | | | | | | | | | | | | | | | | | | | | | | | | | | | | | | | | | | | | | | | | | | | | | | | | | | | | | | | | | | | | | | | | | | | | | | | | | | | | | | | | | | | | | | | | | | | | | | | | | | | | | | | | | | | | | | | | | | | | | | | | | | | | | | | | | | | | | | | | | | | | | | | | | | | | | | | | | | | | | | | | | | | | | | | | | | | | | | | | | | | | | | | | | | | | | | | | | | | | | | | | | | | | | | | | | | | | | | | | | | | | | | | | | | | | | | | | | | | | | | | | | | | | | | | | | | | | | | | | | | | | | | | | | | | | | | | | | | | | | | | | | | | | | | | | | | | | | | | | | | | | | | | | | | | | | | | | | | | | | | | | | | | | | | | | | | | | | | | | | | | | | | | | | | | | | | | | | | | | | | | | | | | | | | | | | | | | | | | | | | | | | | | | | | | | | | | | | | | | | | | | | | | | | | | | | | | | | | | | | | | | | | | | | | | | | | | | | | | | | | | | | | | | | | | | | | | | | | | | | | | | | | | | | | | | | | | | | | | | | | | | | | | | | | | | | | | | | | | |
| 10 | 2.2 | 2.7 | 3.2 | 3.7 | | | | | | | | | | | | | | | | | | | | | | | | | | | | | | | | | | | | | | | | | | | | | | | | | | | | | | | | | | | | | | | | | | | | | | | | | | | | | | | | | | | | | | | | | | | | | | | | | | | | | | | | | | | | | | | | | | | | | | | | | | | | | | | | | | | | | | | | | | | | | | | | | | | | | | | | | | | | | | | | | | | | | | | | | | | | | | | | | | | | | | | | | | | | | | | | | | | | | | | | | | | | | | | | | | | | | | | | | | | | | | | | | | | | | | | | | | | | | | | | | | | | | | | | | | | | | | | | | | | | | | | | | | | | | | | | | | | | | | | | | | | | | | | | | | | | | | | | | | | | | | | | | | | | | | | | | | | | | | | | | | | | | | | | | | | | | | | | | | | | | | | | | | | | | | | | | | | | | | | | | | | | | | | | | | | | | | | | | | | | | | | | | | | | | | | | | | | | | | | | | | | | | | | | | | | | | | | | | | | | | | | | | | | | | | | | | | | | | | | | | | | | | | | | | | | | | | | | | | | | | | | | | | | | | | | | | | | | | | | | | | | | | | | | | | | | | | | | | | | | | | | | | | | | | | | | | | | | | | | | | | | | | | | | | | | | | | | | | | | | | | | | | | | | | | | | | | | | | | | | | | | | | | | | | | | | | | | | | | | | | | | | | | | | | | | | | | | | | | | | | | | | |
| 1/2 ss | | | | | | | | | | | | | | | | | | | | | | | | | | | | | | | | | | | | | | | | | | | | | | | | | | | | | | | | | | | | | | | | | | | | | | | | | | | | | | | | | | | | | | | | | | | | | | | | | | | | | | | | | | | | | | | | | | | | | | | | | | | | | | | | | | | | | | | | | | | | | | | | | | | | | | | | | | | | | | | | | | | | | | | | | | | | | | | | | | | | | | | | | | | | | | | | | | | | | | | | | | | | | | | | | | | | | | | | | | | | | | | | | | | | | | | | | | | | | | | | | | | | | | | | | | | | | | | | | | | | | | | | | | | | | | | | | | | | | | | | | | | | | | | | | | | | | | | | | | | | | | | | | | | | | | | | | | | | | | | | | | | | | | | | | | | | | | | | | | | | | | | | | | | | | | | | | | | | | | | | | | | | | | | | | | | | | | | | | | | | | | | | | | | | | | | | | | | | | | | | | | | | | | | | | | | | | | | | | | | | | | | | | | | | | | | | | | | | | | | | | | | | | | | | | | | | | | | | | | | | | | | | | | | | | | | | | | | | | | | | | | | | | | | | | | | | | | | | | | | | | | | | | | | | | | | | | | | | | | | | | | | | | | | | | | | | | | | | | | | | | | | | | | | | | | | | | | | | | | | | | | | | | | | | | | | | | | | | | | | | | | | | | | | | | | | | | | | | | | | | | | | | | | | | |
| 2 | 4 | 6 | 8 | 10 | | | | | | | | | | | | | | | | | | | | | | | | | | | | | | | | | | | | | | | | | | | | | | | | | | | | | | | | | | | | | | | | | | | | | | | | | | | | | | | | | | | | | | | | | | | | | | | | | | | | | | | | | | | | | | | | | | | | | | | | | | | | | | | | | | | | | | | | | | | | | | | | | | | | | | | | | | | | | | | | | | | | | | | | | | | | | | | | | | | | | | | | | | | | | | | | | | | | | | | | | | | | | | | | | | | | | | | | | | | | | | | | | | | | | | | | | | | | | | | | | | | | | | | | | | | | | | | | | | | | | | | | | | | | | | | | | | | | | | | | | | | | | | | | | | | | | | | | | | | | | | | | | | | | | | | | | | | | | | | | | | | | | | | | | | | | | | | | | | | | | | | | | | | | | | | | | | | | | | | | | | | | | | | | | | | | | | | | | | | | | | | | | | | | | | | | | | | | | | | | | | | | | | | | | | | | | | | | | | | | | | | | | | | | | | | | | | | | | | | | | | | | | | | | | | | | | | | | | | | | | | | | | | | | | | | | | | | | | | | | | | | | | | | | | | | | | | | | | | | | | | | | | | | | | | | | | | | | | | | | | | | | | | | | | | | | | | | | | | | | | | | | | | | | | | | | | | | | | | | | | | | | | | | | | | | | | | | | | | | | | | | | | | | | | | | | | | | | | | | | | | | | |
| 1 | 0.4 | 0.6 | 0.9 | 1.3 | | | | | | | | | | | | | | | | | | | | | | | | | | | | | | | | | | | | | | | | | | | | | | | | | | | | | | | | | | | | | | | | | | | | | | | | | | | | | | | | | | | | | | | | | | | | | | | | | | | | | | | | | | | | | | | | | | | | | | | | | | | | | | | | | | | | | | | | | | | | | | | | | | | | | | | | | | | | | | | | | | | | | | | | | | | | | | | | | | | | | | | | | | | | | | | | | | | | | | | | | | | | | | | | | | | | | | | | | | | | | | | | | | | | | | | | | | | | | | | | | | | | | | | | | | | | | | | | | | | | | | | | | | | | | | | | | | | | | | | | | | | | | | | | | | | | | | | | | | | | | | | | | | | | | | | | | | | | | | | | | | | | | | | | | | | | | | | | | | | | | | | | | | | | | | | | | | | | | | | | | | | | | | | | | | | | | | | | | | | | | | | | | | | | | | | | | | | | | | | | | | | | | | | | | | | | | | | | | | | | | | | | | | | | | | | | | | | | | | | | | | | | | | | | | | | | | | | | | | | | | | | | | | | | | | | | | | | | | | | | | | | | | | | | | | | | | | | | | | | | | | | | | | | | | | | | | | | | | | | | | | | | | | | | | | | | | | | | | | | | | | | | | | | | | | | | | | | | | | | | | | | | | | | | | | | | | | | | | | | | | | | | | | | | | | | | | | | | | | | | | | | | |
| 3 | 1.0 | 1.5 | 2.0 | 2.5 | | | | | | | | | | | | | | | | | | | | | | | | | | | | | | | | | | | | | | | | | | | | | | | | | | | | | | | | | | | | | | | | | | | | | | | | | | | | | | | | | | | | | | | | | | | | | | | | | | | | | | | | | | | | | | | | | | | | | | | | | | | | | | | | | | | | | | | | | | | | | | | | | | | | | | | | | | | | | | | | | | | | | | | | | | | | | | | | | | | | | | | | | | | | | | | | | | | | | | | | | | | | | | | | | | | | | | | | | | | | | | | | | | | | | | | | | | | | | | | | | | | | | | | | | | | | | | | | | | | | | | | | | | | | | | | | | | | | | | | | | | | | | | | | | | | | | | | | | | | | | | | | | | | | | | | | | | | | | | | | | | | | | | | | | | | | | | | | | | | | | | | | | | | | | | | | | | | | | | | | | | | | | | | | | | | | | | | | | | | | | | | | | | | | | | | | | | | | | | | | | | | | | | | | | | | | | | | | | | | | | | | | | | | | | | | | | | | | | | | | | | | | | | | | | | | | | | | | | | | | | | | | | | | | | | | | | | | | | | | | | | | | | | | | | | | | | | | | | | | | | | | | | | | | | | | | | | | | | | | | | | | | | | | | | | | | | | | | | | | | | | | | | | | | | | | | | | | | | | | | | | | | | | | | | | | | | | | | | | | | | | | | | | | | | | | | | | | | | | | | | | | | |
| 5 | 1.6 | 2.1 | 2.6 | 3.1 | | | | | | | | | | | | | | | | | | | | | | | | | | | | | | | | | | | | | | | | | | | | | | | | | | | | | | | | | | | | | | | | | | | | | | | | | | | | | | | | | | | | | | | | | | | | | | | | | | | | | | | | | | | | | | | | | | | | | | | | | | | | | | | | | | | | | | | | | | | | | | | | | | | | | | | | | | | | | | | | | | | | | | | | | | | | | | | | | | | | | | | | | | | | | | | | | | | | | | | | | | | | | | | | | | | | | | | | | | | | | | | | | | | | | | | | | | | | | | | | | | | | | | | | | | | | | | | | | | | | | | | | | | | | | | | | | | | | | | | | | | | | | | | | | | | | | | | | | | | | | | | | | | | | | | | | | | | | | | | | | | | | | | | | | | | | | | | | | | | | | | | | | | | | | | | | | | | | | | | | | | | | | | | | | | | | | | | | | | | | | | | | | | | | | | | | | | | | | | | | | | | | | | | | | | | | | | | | | | | | | | | | | | | | | | | | | | | | | | | | | | | | | | | | | | | | | | | | | | | | | | | | | | | | | | | | | | | | | | | | | | | | | | | | | | | | | | | | | | | | | | | | | | | | | | | | | | | | | | | | | | | | | | | | | | | | | | | | | | | | | | | | | | | | | | | | | | | | | | | | | | | | | | | | | | | | | | | | | | | | | | | | | | | | | | | | | | | | | | | | | | | | |
| 7 | 2.2 | 2.7 | 3.2 | 3.7 | | | | | | | | | | | | | | | | | | | | | | | | | | | | | | | | | | | | | | | | | | | | | | | | | | | | | | | | | | | | | | | | | | | | | | | | | | | | | | | | | | | | | | | | | | | | | | | | | | | | | | | | | | | | | | | | | | | | | | | | | | | | | | | | | | | | | | | | | | | | | | | | | | | | | | | | | | | | | | | | | | | | | | | | | | | | | | | | | | | | | | | | | | | | | | | | | | | | | | | | | | | | | | | | | | | | | | | | | | | | | | | | | | | | | | | | | | | | | | | | | | | | | | | | | | | | | | | | | | | | | | | | | | | | | | | | | | | | | | | | | | | | | | | | | | | | | | | | | | | | | | | | | | | | | | | | | | | | | | | | | | | | | | | | | | | | | | | | | | | | | | | | | | | | | | | | | | | | | | | | | | | | | | | | | | | | | | | | | | | | | | | | | | | | | | | | | | | | | | | | | | | | | | | | | | | | | | | | | | | | | | | | | | | | | | | | | | | | | | | | | | | | | | | | | | | | | | | | | | | | | | | | | | | | | | | | | | | | | | | | | | | | | | | | | | | | | | | | | | | | | | | | | | | | | | | | | | | | | | | | | | | | | | | | | | | | | | | | | | | | | | | | | | | | | | | | | | | | | | | | | | | | | | | | | | | | | | | | | | | | | | | | | | | | | | | | | | | | | | | | | | | | |
| 1/2 ss | | | | | | | | | | | | | | | | | | | | | | | | | | | | | | | | | | | | | | | | | | | | | | | | | | | | | | | | | | | | | | | | | | | | | | | | | | | | | | | | | | | | | | | | | | | | | | | | | | | | | | | | | | | | | | | | | | | | | | | | | | | | | | | | | | | | | | | | | | | | | | | | | | | | | | | | | | | | | | | | | | | | | | | | | | | | | | | | | | | | | | | | | | | | | | | | | | | | | | | | | | | | | | | | | | | | | | | | | | | | | | | | | | | | | | | | | | | | | | | | | | | | | | | | | | | | | | | | | | | | | | | | | | | | | | | | | | | | | | | | | | | | | | | | | | | | | | | | | | | | | | | | | | | | | | | | | | | | | | | | | | | | | | | | | | | | | | | | | | | | | | | | | | | | | | | | | | | | | | | | | | | | | | | | | | | | | | | | | | | | | | | | | | | | | | | | | | | | | | | | | | | | | | | | | | | | | | | | | | | | | | | | | | | | | | | | | | | | | | | | | | | | | | | | | | | | | | | | | | | | | | | | | | | | | | | | | | | | | | | | | | | | | | | | | | | | | | | | | | | | | | | | | | | | | | | | | | | | | | | | | | | | | | | | | | | | | | | | | | | | | | | | | | | | | | | | | | | | | | | | | | | | | | | | | | | | | | | | | | | | | | | | | | | | | | | | | | | | | | | | | | | | | | | | |
| 2 | 4 | 6 | 8 | 10 | | | | | | | | | | | | | | | | | | | | | | | | | | | | | | | | | | | | | | | | | | | | | | | | | | | | | | | | | | | | | | | | | | | | | | | | | | | | | | | | | | | | | | | | | | | | | | | | | | | | | | | | | | | | | | | | | | | | | | | | | | | | | | | | | | | | | | | | | | | | | | | | | | | | | | | | | | | | | | | | | | | | | | | | | | | | | | | | | | | | | | | | | | | | | | | | | | | | | | | | | | | | | | | | | | | | | | | | | | | | | | | | | | | | | | | | | | | | | | | | | | | | | | | | | | | | | | | | | | | | | | | | | | | | | | | | | | | | | | | | | | | | | | | | | | | | | | | | | | | | | | | | | | | | | | | | | | | | | | | | | | | | | | | | | | | | | | | | | | | | | | | | | | | | | | | | | | | | | | | | | | | | | | | | | | | | | | | | | | | | | | | | | | | | | | | | | | | | | | | | | | | | | | | | | | | | | | | | | | | | | | | | | | | | | | | | | | | | | | | | | | | | | | | | | | | | | | | | | | | | | | | | | | | | | | | | | | | | | | | | | | | | | | | | | | | | | | | | | | | | | | | | | | | | | | | | | | | | | | | | | | | | | | | | | | | | | | | | | | | | | | | | | | | | | | | | | | | | | | | | | | | | | | | | | | | | | | | | | | | | | | | | | | | | | | | | | | | | | | | | | | | | |
| 0.1 | 0.3 | 0.6 | 1.0 | 1.4 | | | | | | | | | | | | | | | | | | | | | | | | | | | | | | | | | | | | | | | | | | | | | | | | | | | | | | | | | | | | | | | | | | | | | | | | | | | | | | | | | | | | | | | | | | | | | | | | | | | | | | | | | | | | | | | | | | | | | | | | | | | | | | | | | | | | | | | | | | | | | | | | | | | | | | | | | | | | | | | | | | | | | | | | | | | | | | | | | | | | | | | | | | | | | | | | | | | | | | | | | | | | | | | | | | | | | | | | | | | | | | | | | | | | | | | | | | | | | | | | | | | | | | | | | | | | | | | | | | | | | | | | | | | | | | | | | | | | | | | | | | | | | | | | | | | | | | | | | | | | | | | | | | | | | | | | | | | | | | | | | | | | | | | | | | | | | | | | | | | | | | | | | | | | | | | | | | | | | | | | | | | | | | | | | | | | | | | | | | | | | | | | | | | | | | | | | | | | | | | | | | | | | | | | | | | | | | | | | | | | | | | | | | | | | | | | | | | | | | | | | | | | | | | | | | | | | | | | | | | | | | | | | | | | | | | | | | | | | | | | | | | | | | | | | | | | | | | | | | | | | | | | | | | | | | | | | | | | | | | | | | | | | | | | | | | | | | | | | | | | | | | | | | | | | | | | | | | | | | | | | | | | | | | | | | | | | | | | | | | | | | | | | | | | | | | | | | | | | | | | | | | | |
| 1/2 ss | | | | | | | | | | | | | | | | | | | | | | | | | | | | | | | | | | | | | | | | | | | | | | | | | | | | | | | | | | | | | | | | | | | | | | | | | | | | | | | | | | | | | | | | | | | | | | | | | | | | | | | | | | | | | | | | | | | | | | | | | | | | | | | | | | | | | | | | | | | | | | | | | | | | | | | | | | | | | | | | | | | | | | | | | | | | | | | | | | | | | | | | | | | | | | | | | | | | | | | | | | | | | | | | | | | | | | | | | | | | | | | | | | | | | | | | | | | | | | | | | | | | | | | | | | | | | | | | | | | | | | | | | | | | | | | | | | | | | | | | | | | | | | | | | | | | | | | | | | | | | | | | | | | | | | | | | | | | | | | | | | | | | | | | | | | | | | | | | | | | | | | | | | | | | | | | | | | | | | | | | | | | | | | | | | | | | | | | | | | | | | | | | | | | | | | | | | | | | | | | | | | | | | | | | | | | | | | | | | | | | | | | | | | | | | | | | | | | | | | | | | | | | | | | | | | | | | | | | | | | | | | | | | | | | | | | | | | | | | | | | | | | | | | | | | | | | | | | | | | | | | | | | | | | | | | | | | | | | | | | | | | | | | | | | | | | | | | | | | | | | | | | | | | | | | | | | | | | | | | | | | | | | | | | | | | | | | | | | | | | | | | | | | | | | | | | | | | | | | | | | | | | | | | | |
| 1 | 3 | 5 | 7 | 9 | | | | | | | | | | | | | | | | | | | | | | | | | | | | | | | | | | | | | | | | | | | | | | | | | | | | | | | | | | | | | | | | | | | | | | | | | | | | | | | | | | | | | | | | | | | | | | | | | | | | | | | | | | | | | | | | | | | | | | | | | | | | | | | | | | | | | | | | | | | | | | | | | | | | | | | | | | | | | | | | | | | | | | | | | | | | | | | | | | | | | | | | | | | | | | | | | | | | | | | | | | | | | | | | | | | | | | | | | | | | | | | | | | | | | | | | | | | | | | | | | | | | | | | | | | | | | | | | | | | | | | | | | | | | | | | | | | | | | | | | | | | | | | | | | | | | | | | | | | | | | | | | | | | | | | | | | | | | | | | | | | | | | | | | | | | | | | | | | | | | | | | | | | | | | | | | | | | | | | | | | | | | | | | | | | | | | | | | | | | | | | | | | | | | | | | | | | | | | | | | | | | | | | | | | | | | | | | | | | | | | | | | | | | | | | | | | | | | | | | | | | | | | | | | | | | | | | | | | | | | | | | | | | | | | | | | | | | | | | | | | | | | | | | | | | | | | | | | | | | | | | | | | | | | | | | | | | | | | | | | | | | | | | | | | | | | | | | | | | | | | | | | | | | | | | | | | | | | | | | | | | | | | | | | | | | | | | | | | | | | | | | | | | | | | | | | | | | | | | | | | | | | |
| 2.4 | 2.7 | 3.2 | 4.2 | 5.7 | | | | | | | | | | | | | | | | | | | | | | | | | | | | | | | | | | | | | | | | | | | | | | | | | | | | | | | | | | | | | | | | | | | | | | | | | | | | | | | | | | | | | | | | | | | | | | | | | | | | | | | | | | | | | | | | | | | | | | | | | | | | | | | | | | | | | | | | | | | | | | | | | | | | | | | | | | | | | | | | | | | | | | | | | | | | | | | | | | | | | | | | | | | | | | | | | | | | | | | | | | | | | | | | | | | | | | | | | | | | | | | | | | | | | | | | | | | | | | | | | | | | | | | | | | | | | | | | | | | | | | | | | | | | | | | | | | | | | | | | | | | | | | | | | | | | | | | | | | | | | | | | | | | | | | | | | | | | | | | | | | | | | | | | | | | | | | | | | | | | | | | | | | | | | | | | | | | | | | | | | | | | | | | | | | | | | | | | | | | | | | | | | | | | | | | | | | | | | | | | | | | | | | | | | | | | | | | | | | | | | | | | | | | | | | | | | | | | | | | | | | | | | | | | | | | | | | | | | | | | | | | | | | | | | | | | | | | | | | | | | | | | | | | | | | | | | | | | | | | | | | | | | | | | | | | | | | | | | | | | | | | | | | | | | | | | | | | | | | | | | | | | | | | | | | | | | | | | | | | | | | | | | | | | | | | | | | | | | | | | | | | | | | | | | | | | | | | | | | | | | | | | |
| 1/2 ss | | | | | | | | | | | | | | | | | | | | | | | | | | | | | | | | | | | | | | | | | | | | | | | | | | | | | | | | | | | | | | | | | | | | | | | | | | | | | | | | | | | | | | | | | | | | | | | | | | | | | | | | | | | | | | | | | | | | | | | | | | | | | | | | | | | | | | | | | | | | | | | | | | | | | | | | | | | | | | | | | | | | | | | | | | | | | | | | | | | | | | | | | | | | | | | | | | | | | | | | | | | | | | | | | | | | | | | | | | | | | | | | | | | | | | | | | | | | | | | | | | | | | | | | | | | | | | | | | | | | | | | | | | | | | | | | | | | | | | | | | | | | | | | | | | | | | | | | | | | | | | | | | | | | | | | | | | | | | | | | | | | | | | | | | | | | | | | | | | | | | | | | | | | | | | | | | | | | | | | | | | | | | | | | | | | | | | | | | | | | | | | | | | | | | | | | | | | | | | | | | | | | | | | | | | | | | | | | | | | | | | | | | | | | | | | | | | | | | | | | | | | | | | | | | | | | | | | | | | | | | | | | | | | | | | | | | | | | | | | | | | | | | | | | | | | | | | | | | | | | | | | | | | | | | | | | | | | | | | | | | | | | | | | | | | | | | | | | | | | | | | | | | | | | | | | | | | | | | | | | | | | | | | | | | | | | | | | | | | | | | | | | | | | | | | | | | | | | | | | | | | | | | | | | |
| 1 | 3 | 5 | 7 | 9 | | | | | | | | | | | | | | | | | | | | | | | | | | | | | | | | | | | | | | | | | | | | | | | | | | | | | | | | | | | | | | | | | | | | | | | | | | | | | | | | | | | | | | | | | | | | | | | | | | | | | | | | | | | | | | | | | | | | | | | | | | | | | | | | | | | | | | | | | | | | | | | | | | | | | | | | | | | | | | | | | | | | | | | | | | | | | | | | | | | | | | | | | | | | | | | | | | | | | | | | | | | | | | | | | | | | | | | | | | | | | | | | | | | | | | | | | | | | | | | | | | | | | | | | | | | | | | | | | | | | | | | | | | | | | | | | | | | | | | | | | | | | | | | | | | | | | | | | | | | | | | | | | | | | | | | | | | | | | | | | | | | | | | | | | | | | | | | | | | | | | | | | | | | | | | | | | | | | | | | | | | | | | | | | | | | | | | | | | | | | | | | | | | | | | | | | | | | | | | | | | | | | | | | | | | | | | | | | | | | | | | | | | | | | | | | | | | | | | | | | | | | | | | | | | | | | | | | | | | | | | | | | | | | | | | | | | | | | | | | | | | | | | | | | | | | | | | | | | | | | | | | | | | | | | | | | | | | | | | | | | | | | | | | | | | | | | | | | | | | | | | | | | | | | | | | | | | | | | | | | | | | | | | | | | | | | | | | | | | | | | | | | | | | | | | | | | | | | | | | | | | | | |
| 0.0 | 0.1 | 0.3 | 0.5 | 0.7 | | | | | | | | | | | | | | | | | | | | | | | | | | | | | | | | | | | | | | | | | | | | | | | | | | | | | | | | | | | | | | | | | | | | | | | | | | | | | | | | | | | | | | | | | | | | | | | | | | | | | | | | | | | | | | | | | | | | | | | | | | | | | | | | | | | | | | | | | | | | | | | | | | | | | | | | | | | | | | | | | | | | | | | | | | | | | | | | | | | | | | | | | | | | | | | | | | | | | | | | | | | | | | | | | | | | | | | | | | | | | | | | | | | | | | | | | | | | | | | | | | | | | | | | | | | | | | | | | | | | | | | | | | | | | | | | | | | | | | | | | | | | | | | | | | | | | | | | | | | | | | | | | | | | | | | | | | | | | | | | | | | | | | | | | | | | | | | | | | | | | | | | | | | | | | | | | | | | | | | | | | | | | | | | | | | | | | | | | | | | | | | | | | | | | | | | | | | | | | | | | | | | | | | | | | | | | | | | | | | | | | | | | | | | | | | | | | | | | | | | | | | | | | | | | | | | | | | | | | | | | | | | | | | | | | | | | | | | | | | | | | | | | | | | | | | | | | | | | | | | | | | | | | | | | | | | | | | | | | | | | | | | | | | | | | | | | | | | | | | | | | | | | | | | | | | | | | | | | | | | | | | | | | | | | | | | | | | | | | | | | | | | | | | | | | | | | | | | | | | | | | | | |
| 1/2 ss | | | | | | | | | | | | | | | | | | | | | | | | | | | | | | | | | | | | | | | | | | | | | | | | | | | | | | | | | | | | | | | | | | | | | | | | | | | | | | | | | | | | | | | | | | | | | | | | | | | | | | | | | | | | | | | | | | | | | | | | | | | | | | | | | | | | | | | | | | | | | | | | | | | | | | | | | | | | | | | | | | | | | | | | | | | | | | | | | | | | | | | | | | | | | | | | | | | | | | | | | | | | | | | | | | | | | | | | | | | | | | | | | | | | | | | | | | | | | | | | | | | | | | | | | | | | | | | | | | | | | | | | | | | | | | | | | | | | | | | | | | | | | | | | | | | | | | | | | | | | | | | | | | | | | | | | | | | | | | | | | | | | | | | | | | | | | | | | | | | | | | | | | | | | | | | | | | | | | | | | | | | | | | | | | | | | | | | | | | | | | | | | | | | | | | | | | | | | | | | | | | | | | | | | | | | | | | | | | | | | | | | | | | | | | | | | | | | | | | | | | | | | | | | | | | | | | | | | | | | | | | | | | | | | | | | | | | | | | | | | | | | | | | | | | | | | | | | | | | | | | | | | | | | | | | | | | | | | | | | | | | | | | | | | | | | | | | | | | | | | | | | | | | | | | | | | | | | | | | | | | | | | | | | | | | | | | | | | | | | | | | | | | | | | | | | | | | | | | | | | | | | | | | | | |
| 1 | 3 | 5 | 7 | 9 | | | | | | | | | | | | | | | | | | | | | | | | | | | | | | | | | | | | | | | | | | | | | | | | | | | | | | | | | | | | | | | | | | | | | | | | | | | | | | | | | | | | | | | | | | | | | | | | | | | | | | | | | | | | | | | | | | | | | | | | | | | | | | | | | | | | | | | | | | | | | | | | | | | | | | | | | | | | | | | | | | | | | | | | | | | | | | | | | | | | | | | | | | | | | | | | | | | | | | | | | | | | | | | | | | | | | | | | | | | | | | | | | | | | | | | | | | | | | | | | | | | | | | | | | | | | | | | | | | | | | | | | | | | | | | | | | | | | | | | | | | | | | | | | | | | | | | | | | | | | | | | | | | | | | | | | | | | | | | | | | | | | | | | | | | | | | | | | | | | | | | | | | | | | | | | | | | | | | | | | | | | | | | | | | | | | | | | | | | | | | | | | | | | | | | | | | | | | | | | | | | | | | | | | | | | | | | | | | | | | | | | | | | | | | | | | | | | | | | | | | | | | | | | | | | | | | | | | | | | | | | | | | | | | | | | | | | | | | | | | | | | | | | | | | | | | | | | | | | | | | | | | | | | | | | | | | | | | | | | | | | | | | | | | | | | | | | | | | | | | | | | | | | | | | | | | | | | | | | | | | | | | | | | | | | | | | | | | | | | | | | | | | | | | | | | | | | | | | | | | | | | | |
| 1 | 0.0 | 0.1 | 0.3 | 0.5 | | | | | | | | | | | | | | | | | | | | | | | | | | | | | | | | | | | | | | | | | | | | | | | | | | | | | | | | | | | | | | | | | | | | | | | | | | | | | | | | | | | | | | | | | | | | | | | | | | | | | | | | | | | | | | | | | | | | | | | | | | | | | | | | | | | | | | | | | | | | | | | | | | | | | | | | | | | | | | | | | | | | | | | | | | | | | | | | | | | | | | | | | | | | | | | | | | | | | | | | | | | | | | | | | | | | | | | | | | | | | | | | | | | | | | | | | | | | | | | | | | | | | | | | | | | | | | | | | | | | | | | | | | | | | | | | | | | | | | | | | | | | | | | | | | | | | | | | | | | | | | | | | | | | | | | | | | | | | | | | | | | | | | | | | | | | | | | | | | | | | | | | | | | | | | | | | | | | | | | | | | | | | | | | | | | | | | | | | | | | | | | | | | | | | | | | | | | | | | | | | | | | | | | | | | | | | | | | | | | | | | | | | | | | | | | | | | | | | | | | | | | | | | | | | | | | | | | | | | | | | | | | | | | | | | | | | | | | | | | | | | | | | | | | | | | | | | | | | | | | | | | | | | | | | | | | | | | | | | | | | | | | | | | | | | | | | | | | | | | | | | | | | | | | | | | | | | | | | | | | | | | | | | | | | | | | | | | | | | | | | | | | | | | | | | | | | | | | | | | | | | | | |
| 3 | 0.6 | 0.9 | 1.4 | 2.0 | | | | | | | | | | | | | | | | | | | | | | | | | | | | | | | | | | | | | | | | | | | | | | | | | | | | | | | | | | | | | | | | | | | | | | | | | | | | | | | | | | | | | | | | | | | | | | | | | | | | | | | | | | | | | | | | | | | | | | | | | | | | | | | | | | | | | | | | | | | | | | | | | | | | | | | | | | | | | | | | | | | | | | | | | | | | | | | | | | | | | | | | | | | | | | | | | | | | | | | | | | | | | | | | | | | | | | | | | | | | | | | | | | | | | | | | | | | | | | | | | | | | | | | | | | | | | | | | | | | | | | | | | | | | | | | | | | | | | | | | | | | | | | | | | | | | | | | | | | | | | | | | | | | | | | | | | | | | | | | | | | | | | | | | | | | | | | | | | | | | | | | | | | | | | | | | | | | | | | | | | | | | | | | | | | | | | | | | | | | | | | | | | | | | | | | | | | | | | | | | | | | | | | | | | | | | | | | | | | | | | | | | | | | | | | | | | | | | | | | | | | | | | | | | | | | | | | | | | | | | | | | | | | | | | | | | | | | | | | | | | | | | | | | | | | | | | | | | | | | | | | | | | | | | | | | | | | | | | | | | | | | | | | | | | | | | | | | | | | | | | | | | | | | | | | | | | | | | | | | | | | | | | | | | | | | | | | | | | | | | | | | | | | | | | | | | | | | | | | | | | | | | |
| 5 | 1.2 | 1.7 | 2.2 | 2.7 | | | | | | | | | | | | | | | | | | | | | | | | | | | | | | | | | | | | | | | | | | | | | | | | | | | | | | | | | | | | | | | | | | | | | | | | | | | | | | | | | | | | | | | | | | | | | | | | | | | | | | | | | | | | | | | | | | | | | | | | | | | | | | | | | | | | | | | | | | | | | | | | | | | | | | | | | | | | | | | | | | | | | | | | | | | | | | | | | | | | | | | | | | | | | | | | | | | | | | | | | | | | | | | | | | | | | | | | | | | | | | | | | | | | | | | | | | | | | | | | | | | | | | | | | | | | | | | | | | | | | | | | | | | | | | | | | | | | | | | | | | | | | | | | | | | | | | | | | | | | | | | | | | | | | | | | | | | | | | | | | | | | | | | | | | | | | | | | | | | | | | | | | | | | | | | | | | | | | | | | | | | | | | | | | | | | | | | | | | | | | | | | | | | | | | | | | | | | | | | | | | | | | | | | | | | | | | | | | | | | | | | | | | | | | | | | | | | | | | | | | | | | | | | | | | | | | | | | | | | | | | | | | | | | | | | | | | | | | | | | | | | | | | | | | | | | | | | | | | | | | | | | | | | | | | | | | | | | | | | | | | | | | | | | | | | | | | | | | | | | | | | | | | | | | | | | | | | | | | | | | | | | | | | | | | | | | | | | | | | | | | | | | | | | | | | | | | | | | | | | | | | | |
| 7 | 1.8 | 2.3 | 2.8 | 3.3 | | | | | | | | | | | | | | | | | | | | | | | | | | | | | | | | | | | | | | | | | | | | | | | | | | | | | | | | | | | | | | | | | | | | | | | | | | | | | | | | | | | | | | | | | | | | | | | | | | | | | | | | | | | | | | | | | | | | | | | | | | | | | | | | | | | | | | | | | | | | | | | | | | | | | | | | | | | | | | | | | | | | | | | | | | | | | | | | | | | | | | | | | | | | | | | | | | | | | | | | | | | | | | | | | | | | | | | | | | | | | | | | | | | | | | | | | | | | | | | | | | | | | | | | | | | | | | | | | | | | | | | | | | | | | | | | | | | | | | | | | | | | | | | | | | | | | | | | | | | | | | | | | | | | | | | | | | | | | | | | | | | | | | | | | | | | | | | | | | | | | | | | | | | | | | | | | | | | | | | | | | | | | | | | | | | | | | | | | | | | | | | | | | | | | | | | | | | | | | | | | | | | | | | | | | | | | | | | | | | | | | | | | | | | | | | | | | | | | | | | | | | | | | | | | | | | | | | | | | | | | | | | | | | | | | | | | | | | | | | | | | | | | | | | | | | | | | | | | | | | | | | | | | | | | | | | | | | | | | | | | | | | | | | | | | | | | | | | | | | | | | | | | | | | | | | | | | | | | | | | | | | | | | | | | | | | | | | | | | | | | | | | | | | | | | | | | | | | | | | | | | | | |
| 1/2 ss | | | | | | | | | | | | | | | | | | | | | | | | | | | | | | | | | | | | | | | | | | | | | | | | | | | | | | | | | | | | | | | | | | | | | | | | | | | | | | | | | | | | | | | | | | | | | | | | | | | | | | | | | | | | | | | | | | | | | | | | | | | | | | | | | | | | | | | | | | | | | | | | | | | | | | | | | | | | | | | | | | | | | | | | | | | | | | | | | | | | | | | | | | | | | | | | | | | | | | | | | | | | | | | | | | | | | | | | | | | | | | | | | | | | | | | | | | | | | | | | | | | | | | | | | | | | | | | | | | | | | | | | | | | | | | | | | | | | | | | | | | | | | | | | | | | | | | | | | | | | | | | | | | | | | | | | | | | | | | | | | | | | | | | | | | | | | | | | | | | | | | | | | | | | | | | | | | | | | | | | | | | | | | | | | | | | | | | | | | | | | | | | | | | | | | | | | | | | | | | | | | | | | | | | | | | | | | | | | | | | | | | | | | | | | | | | | | | | | | | | | | | | | | | | | | | | | | | | | | | | | | | | | | | | | | | | | | | | | | | | | | | | | | | | | | | | | | | | | | | | | | | | | | | | | | | | | | | | | | | | | | | | | | | | | | | | | | | | | | | | | | | | | | | | | | | | | | | | | | | | | | | | | | | | | | | | | | | | | | | | | | | | | | | | | | | | | | | | | | | | | | | | | | | | |
| 1 | 3 | 5 | 7 | 9 | | | | | | | | | | | | | | | | | | | | | | | | | | | | | | | | | | | | | | | | | | | | | | | | | | | | | | | | | | | | | | | | | | | | | | | | | | | | | | | | | | | | | | | | | | | | | | | | | | | | | | | | | | | | | | | | | | | | | | | | | | | | | | | | | | | | | | | | | | | | | | | | | | | | | | | | | | | | | | | | | | | | | | | | | | | | | | | | | | | | | | | | | | | | | | | | | | | | | | | | | | | | | | | | | | | | | | | | | | | | | | | | | | | | | | | | | | | | | | | | | | | | | | | | | | | | | | | | | | | | | | | | | | | | | | | | | | | | | | | | | | | | | | | | | | | | | | | | | | | | | | | | | | | | | | | | | | | | | | | | | | | | | | | | | | | | | | | | | | | | | | | | | | | | | | | | | | | | | | | | | | | | | | | | | | | | | | | | | | | | | | | | | | | | | | | | | | | | | | | | | | | | | | | | | | | | | | | | | | | | | | | | | | | | | | | | | | | | | | | | | | | | | | | | | | | | | | | | | | | | | | | | | | | | | | | | | | | | | | | | | | | | | | | | | | | | | | | | | | | | | | | | | | | | | | | | | | | | | | | | | | | | | | | | | | | | | | | | | | | | | | | | | | | | | | | | | | | | | | | | | | | | | | | | | | | | | | | | | | | | | | | | | | | | | | | | | | | | | | | | | | | | |
| 1 | 0.9 | 1.4 | 2.1 | 2.8 | | | | | | | | | | | | | | | | | | | | | | | | | | | | | | | | | | | | | | | | | | | | | | | | | | | | | | | | | | | | | | | | | | | | | | | | | | | | | | | | | | | | | | | | | | | | | | | | | | | | | | | | | | | | | | | | | | | | | | | | | | | | | | | | | | | | | | | | | | | | | | | | | | | | | | | | | | | | | | | | | | | | | | | | | | | | | | | | | | | | | | | | | | | | | | | | | | | | | | | | | | | | | | | | | | | | | | | | | | | | | | | | | | | | | | | | | | | | | | | | | | | | | | | | | | | | | | | | | | | | | | | | | | | | | | | | | | | | | | | | | | | | | | | | | | | | | | | | | | | | | | | | | | | | | | | | | | | | | | | | | | | | | | | | | | | | | | | | | | | | | | | | | | | | | | | | | | | | | | | | | | | | | | | | | | | | | | | | | | | | | | | | | | | | | | | | | | | | | | | | | | | | | | | | | | | | | | | | | | | | | | | | | | | | | | | | | | | | | | | | | | | | | | | | | | | | | | | | | | | | | | | | | | | | | | | | | | | | | | | | | | | | | | | | | | | | | | | | | | | | | | | | | | | | | | | | | | | | | | | | | | | | | | | | | | | | | | | | | | | | | | | | | | | | | | | | | | | | | | | | | | | | | | | | | | | | | | | | | | | | | | | | | | | | | | | | | | | | | | | | | | | | |
| 4 | 1.6 | 2.3 | 3.0 | 3.7 | | | | | | | | | | | | | | | | | | | | | | | | | | | | | | | | | | | | | | | | | | | | | | | | | | | | | | | | | | | | | | | | | | | | | | | | | | | | | | | | | | | | | | | | | | | | | | | | | | | | | | | | | | | | | | | | | | | | | | | | | | | | | | | | | | | | | | | | | | | | | | | | | | | | | | | | | | | | | | | | | | | | | | | | | | | | | | | | | | | | | | | | | | | | | | | | | | | | | | | | | | | | | | | | | | | | | | | | | | | | | | | | | | | | | | | | | | | | | | | | | | | | | | | | | | | | | | | | | | | | | | | | | | | | | | | | | | | | | | | | | | | | | | | | | | | | | | | | | | | | | | | | | | | | | | | | | | | | | | | | | | | | | | | | | | | | | | | | | | | | | | | | | | | | | | | | | | | | | | | | | | | | | | | | | | | | | | | | | | | | | | | | | | | | | | | | | | | | | | | | | | | | | | | | | | | | | | | | | | | | | | | | | | | | | | | | | | | | | | | | | | | | | | | | | | | | | | | | | | | | | | | | | | | | | | | | | | | | | | | | | | | | | | | | | | | | | | | | | | | | | | | | | | | | | | | | | | | | | | | | | | | | | | | | | | | | | | | | | | | | | | | | | | | | | | | | | | | | | | | | | | | | | | | | | | | | | | | | | | | | | | | | | | | | | | | | | | | | | | | | | | | | |
| 6 | 2.3 | 3.0 | 3.7 | 4.4 | | | | | | | | | | | | | | | | | | | | | | | | | | | | | | | | | | | | | | | | | | | | | | | | | | | | | | | | | | | | | | | | | | | | | | | | | | | | | | | | | | | | | | | | | | | | | | | | | | | | | | | | | | | | | | | | | | | | | | | | | | | | | | | | | | | | | | | | | | | | | | | | | | | | | | | | | | | | | | | | | | | | | | | | | | | | | | | | | | | | | | | | | | | | | | | | | | | | | | | | | | | | | | | | | | | | | | | | | | | | | | | | | | | | | | | | | | | | | | | | | | | | | | | | | | | | | | | | | | | | | | | | | | | | | | | | | | | | | | | | | | | | | | | | | | | | | | | | | | | | | | | | | | | | | | | | | | | | | | | | | | | | | | | | | | | | | | | | | | | | | | | | | | | | | | | | | | | | | | | | | | | | | | | | | | | | | | | | | | | | | | | | | | | | | | | | | | | | | | | | | | | | | | | | | | | | | | | | | | | | | | | | | | | | | | | | | | | | | | | | | | | | | | | | | | | | | | | | | | | | | | | | | | | | | | | | | | | | | | | | | | | | | | | | | | | | | | | | | | | | | | | | | | | | | | | | | | | | | | | | | | | | | | | | | | | | | | | | | | | | | | | | | | | | | | | | | | | | | | | | | | | | | | | | | | | | | | | | | | | | | | | | | | | | | | | | | | | | | | | | | | | | |
| 1/2 ss | | | | | | | | | | | | | | | | | | | | | | | | | | | | | | | | | | | | | | | | | | | | | | | | | | | | | | | | | | | | | | | | | | | | | | | | | | | | | | | | | | | | | | | | | | | | | | | | | | | | | | | | | | | | | | | | | | | | | | | | | | | | | | | | | | | | | | | | | | | | | | | | | | | | | | | | | | | | | | | | | | | | | | | | | | | | | | | | | | | | | | | | | | | | | | | | | | | | | | | | | | | | | | | | | | | | | | | | | | | | | | | | | | | | | | | | | | | | | | | | | | | | | | | | | | | | | | | | | | | | | | | | | | | | | | | | | | | | | | | | | | | | | | | | | | | | | | | | | | | | | | | | | | | | | | | | | | | | | | | | | | | | | | | | | | | | | | | | | | | | | | | | | | | | | | | | | | | | | | | | | | | | | | | | | | | | | | | | | | | | | | | | | | | | | | | | | | | | | | | | | | | | | | | | | | | | | | | | | | | | | | | | | | | | | | | | | | | | | | | | | | | | | | | | | | | | | | | | | | | | | | | | | | | | | | | | | | | | | | | | | | | | | | | | | | | | | | | | | | | | | | | | | | | | | | | | | | | | | | | | | | | | | | | | | | | | | | | | | | | | | | | | | | | | | | | | | | | | | | | | | | | | | | | | | | | | | | | | | | | | | | | | | | | | | | | | | | | | | | | | | | | | | | | | |
| 1 | 3 | 5 | 7 | 9 | | | | | | | | | | | | | | | | | | | | | | | | | | | | | | | | | | | | | | | | | | | | | | | | | | | | | | | | | | | | | | | | | | | | | | | | | | | | | | | | | | | | | | | | | | | | | | | | | | | | | | | | | | | | | | | | | | | | | | | | | | | | | | | | | | | | | | | | | | | | | | | | | | | | | | | | | | | | | | | | | | | | | | | | | | | | | | | | | | | | | | | | | | | | | | | | | | | | | | | | | | | | | | | | | | | | | | | | | | | | | | | | | | | | | | | | | | | | | | | | | | | | | | | | | | | | | | | | | | | | | | | | | | | | | | | | | | | | | | | | | | | | | | | | | | | | | | | | | | | | | | | | | | | | | | | | | | | | | | | | | | | | | | | | | | | | | | | | | | | | | | | | | | | | | | | | | | | | | | | | | | | | | | | | | | | | | | | | | | | | | | | | | | | | | | | | | | | | | | | | | | | | | | | | | | | | | | | | | | | | | | | | | | | | | | | | | | | | | | | | | | | | | | | | | | | | | | | | | | | | | | | | | | | | | | | | | | | | | | | | | | | | | | | | | | | | | | | | | | | | | | | | | | | | | | | | | | | | | | | | | | | | | | | | | | | | | | | | | | | | | | | | | | | | | | | | | | | | | | | | | | | | | | | | | | | | | | | | | | | | | | | | | | | | | | | | | | | | | | | | | | | | |
| 0.1 | 0.4 | 0.8 | 1.2 | 1.6 | | | | | | | | | | | | | | | | | | | | | | | | | | | | | | | | | | | | | | | | | | | | | | | | | | | | | | | | | | | | | | | | | | | | | | | | | | | | | | | | | | | | | | | | | | | | | | | | | | | | | | | | | | | | | | | | | | | | | | | | | | | | | | | | | | | | | | | | | | | | | | | | | | | | | | | | | | | | | | | | | | | | | | | | | | | | | | | | | | | | | | | | | | | | | | | | | | | | | | | | | | | | | | | | | | | | | | | | | | | | | | | | | | | | | | | | | | | | | | | | | | | | | | | | | | | | | | | | | | | | | | | | | | | | | | | | | | | | | | | | | | | | | | | | | | | | | | | | | | | | | | | | | | | | | | | | | | | | | | | | | | | | | | | | | | | | | | | | | | | | | | | | | | | | | | | | | | | | | | | | | | | | | | | | | | | | | | | | | | | | | | | | | | | | | | | | | | | | | | | | | | | | | | | | | | | | | | | | | | | | | | | | | | | | | | | | | | | | | | | | | | | | | | | | | | | | | | | | | | | | | | | | | | | | | | | | | | | | | | | | | | | | | | | | | | | | | | | | | | | | | | | | | | | | | | | | | | | | | | | | | | | | | | | | | | | | | | | | | | | | | | | | | | | | | | | | | | | | | | | | | | | | | | | | | | | | | | | | | | | | | | | | | | | | | | | | | | | | | | | | | | | | |
| 1/2 ss | | | | | | | | | | | | | | | | | | | | | | | | | | | | | | | | | | | | | | | | | | | | | | | | | | | | | | | | | | | | | | | | | | | | | | | | | | | | | | | | | | | | | | | | | | | | | | | | | | | | | | | | | | | | | | | | | | | | | | | | | | | | | | | | | | | | | | | | | | | | | | | | | | | | | | | | | | | | | | | | | | | | | | | | | | | | | | | | | | | | | | | | | | | | | | | | | | | | | | | | | | | | | | | | | | | | | | | | | | | | | | | | | | | | | | | | | | | | | | | | | | | | | | | | | | | | | | | | | | | | | | | | | | | | | | | | | | | | | | | | | | | | | | | | | | | | | | | | | | | | | | | | | | | | | | | | | | | | | | | | | | | | | | | | | | | | | | | | | | | | | | | | | | | | | | | | | | | | | | | | | | | | | | | | | | | | | | | | | | | | | | | | | | | | | | | | | | | | | | | | | | | | | | | | | | | | | | | | | | | | | | | | | | | | | | | | | | | | | | | | | | | | | | | | | | | | | | | | | | | | | | | | | | | | | | | | | | | | | | | | | | | | | | | | | | | | | | | | | | | | | | | | | | | | | | | | | | | | | | | | | | | | | | | | | | | | | | | | | | | | | | | | | | | | | | | | | | | | | | | | | | | | | | | | | | | | | | | | | | | | | | | | | | | | | | | | | | | | | | | | | | | | | | | | |
| 1 | 3 | 5 | 7 | 9 | | | | | | | | | | | | | | | | | | | | | | | | | | | | | | | | | | | | | | | | | | | | | | | | | | | | | | | | | | | | | | | | | | | | | | | | | | | | | | | | | | | | | | | | | | | | | | | | | | | | | | | | | | | | | | | | | | | | | | | | | | | | | | | | | | | | | | | | | | | | | | | | | | | | | | | | | | | | | | | | | | | | | | | | | | | | | | | | | | | | | | | | | | | | | | | | | | | | | | | | | | | | | | | | | | | | | | | | | | | | | | | | | | | | | | | | | | | | | | | | | | | | | | | | | | | | | | | | | | | | | | | | | | | | | | | | | | | | | | | | | | | | | | | | | | | | | | | | | | | | | | | | | | | | | | | | | | | | | | | | | | | | | | | | | | | | | | | | | | | | | | | | | | | | | | | | | | | | | | | | | | | | | | | | | | | | | | | | | | | | | | | | | | | | | | | | | | | | | | | | | | | | | | | | | | | | | | | | | | | | | | | | | | | | | | | | | | | | | | | | | | | | | | | | | | | | | | | | | | | | | | | | | | | | | | | | | | | | | | | | | | | | | | | | | | | | | | | | | | | | | | | | | | | | | | | | | | | | | | | | | | | | | | | | | | | | | | | | | | | | | | | | | | | | | | | | | | | | | | | | | | | | | | | | | | | | | | | | | | | | | | | | | | | | | | | | | | | | | | | | | | | | |
| 2.4 | 2.7 | 3.2 | 4.2 | 5.7 | | | | | | | | | | | | | | | | | | | | | | | | | | | | | | | | | | | | | | | | | | | | | | | | | | | | | | | | | | | | | | | | | | | | | | | | | | | | | | | | | | | | | | | | | | | | | | | | | | | | | | | | | | | | | | | | | | | | | | | | | | | | | | | | | | | | | | | | | | | | | | | | | | | | | | | | | | | | | | | | | | | | | | | | | | | | | | | | | | | | | | | | | | | | | | | | | | | | | | | | | | | | | | | | | | | | | | | | | | | | | | | | | | | | | | | | | | | | | | | | | | | | | | | | | | | | | | | | | | | | | | | | | | | | | | | | | | | | | | | | | | | | | | | | | | | | | | | | | | | | | | | | | | | | | | | | | | | | | | | | | | | | | | | | | | | | | | | | | | | | | | | | | | | | | | | | | | | | | | | | | | | | | | | | | | | | | | | | | | | | | | | | | | | | | | | | | | | | | | | | | | | | | | | | | | | | | | | | | | | | | | | | | | | | | | | | | | | | | | | | | | | | | | | | | | | | | | | | | | | | | | | | | | | | | | | | | | | | | | | | | | | | | | | | | | | | | | | | | | | | | | | | | | | | | | | | | | | | | | | | | | | | | | | | | | | | | | | | | | | | | | | | | | | | | | | | | | | | | | | | | | | | | | | | | | | | | | | | | | | | | | | | | | | | | | | | | | | | | | | | | | | | |
| 1/2 ss | | | | | | | | | | | | | | | | | | | | | | | | | | | | | | | | | | | | | | | | | | | | | | | | | | | | | | | | | | | | | | | | | | | | | | | | | | | | | | | | | | | | | | | | | | | | | | | | | | | | | | | | | | | | | | | | | | | | | | | | | | | | | | | | | | | | | | | | | | | | | | | | | | | | | | | | | | | | | | | | | | | | | | | | | | | | | | | | | | | | | | | | | | | | | | | | | | | | | | | | | | | | | | | | | | | | | | | | | | | | | | | | | | | | | | | | | | | | | | | | | | | | | | | | | | | | | | | | | | | | | | | | | | | | | | | | | | | | | | | | | | | | | | | | | | | | | | | | | | | | | | | | | | | | | | | | | | | | | | | | | | | | | | | | | | | | | | | | | | | | | | | | | | | | | | | | | | | | | | | | | | | | | | | | | | | | | | | | | | | | | | | | | | | | | | | | | | | | | | | | | | | | | | | | | | | | | | | | | | | | | | | | | | | | | | | | | | | | | | | | | | | | | | | | | | | | | | | | | | | | | | | | | | | | | | | | | | | | | | | | | | | | | | | | | | | | | | | | | | | | | | | | | | | | | | | | | | | | | | | | | | | | | | | | | | | | | | | | | | | | | | | | | | | | | | | | | | | | | | | | | | | | | | | | | | | | | | | | | | | | | | | | | | | | | | | | | | | | | | | | | | | | | | | | |
| 1 | 3 | 5 | 7 | 9 | | | | | | | | | | | | | | | | | | | | | | | | | | | | | | | | | | | | | | | | | | | | | | | | | | | | | | | | | | | | | | | | | | | | | | | | | | | | | | | | | | | | | | | | | | | | | | | | | | | | | | | | | | | | | | | | | | | | | | | | | | | | | | | | | | | | | | | | | | | | | | | | | | | | | | | | | | | | | | | | | | | | | | | | | | | | | | | | | | | | | | | | | | | | | | | | | | | | | | | | | | | | | | | | | | | | | | | | | | | | | | | | | | | | | | | | | | | | | | | | | | | | | | | | | | | | | | | | | | | | | | | | | | | | | | | | | | | | | | | | | | | | | | | | | | | | | | | | | | | | | | | | | | | | | | | | | | | | | | | | | | | | | | | | | | | | | | | | | | | | | | | | | | | | | | | | | | | | | | | | | | | | | | | | | | | | | | | | | | | | | | | | | | | | | | | | | | | | | | | | | | | | | | | | | | | | | | | | | | | | | | | | | | | | | | | | | | | | | | | | | | | | | | | | | | | | | | | | | | | | | | | | | | | | | | | | | | | | | | | | | | | | | | | | | | | | | | | | | | | | | | | | | | | | | | | | | | | | | | | | | | | | | | | | | | | | | | | | | | | | | | | | | | | | | | | | | | | | | | | | | | | | | | | | | | | | | | | | | | | | | | | | | | | | | | | | | | | | | | | | | | | | |
| 0.0 | 0.0 | 0.3 | 0.5 | 0.7 | | | | | | | | | | | | | | | | | | | | | | | | | | | | | | | | | | | | | | | | | | | | | | | | | | | | | | | | | | | | | | | | | | | | | | | | | | | | | | | | | | | | | | | | | | | | | | | | | | | | | | | | | | | | | | | | | | | | | | | | | | | | | | | | | | | | | | | | | | | | | | | | | | | | | | | | | | | | | | | | | | | | | | | | | | | | | | | | | | | | | | | | | | | | | | | | | | | | | | | | | | | | | | | | | | | | | | | | | | | | | | | | | | | | | | | | | | | | | | | | | | | | | | | | | | | | | | | | | | | | | | | | | | | | | | | | | | | | | | | | | | | | | | | | | | | | | | | | | | | | | | | | | | | | | | | | | | | | | | | | | | | | | | | | | | | | | | | | | | | | | | | | | | | | | | | | | | | | | | | | | | | | | | | | | | | | | | | | | | | | | | | | | | | | | | | | | | | | | | | | | | | | | | | | | | | | | | | | | | | | | | | | | | | | | | | | | | | | | | | | | | | | | | | | | | | | | | | | | | | | | | | | | | | | | | | | | | | | | | | | | | | | | | | | | | | | | | | | | | | | | | | | | | | | | | | | | | | | | | | | | | | | | | | | | | | | | | | | | | | | | | | | | | | | | | | | | | | | | | | | | | | | | | | | | | | | | | | | | | | | | | | | | | | | | | | | | | | | | | | | | | | | |
| 1/2 ss | | | | | | | | | | | | | | | | | | | | | | | | | | | | | | | | | | | | | | | | | | | | | | | | | | | | | | | | | | | | | | | | | | | | | | | | | | | | | | | | | | | | | | | | | | | | | | | | | | | | | | | | | | | | | | | | | | | | | | | | | | | | | | | | | | | | | | | | | | | | | | | | | | | | | | | | | | | | | | | | | | | | | | | | | | | | | | | | | | | | | | | | | | | | | | | | | | | | | | | | | | | | | | | | | | | | | | | | | | | | | | | | | | | | | | | | | | | | | | | | | | | | | | | | | | | | | | | | | | | | | | | | | | | | | | | | | | | | | | | | | | | | | | | | | | | | | | | | | | | | | | | | | | | | | | | | | | | | | | | | | | | | | | | | | | | | | | | | | | | | | | | | | | | | | | | | | | | | | | | | | | | | | | | | | | | | | | | | | | | | | | | | | | | | | | | | | | | | | | | | | | | | | | | | | | | | | | | | | | | | | | | | | | | | | | | | | | | | | | | | | | | | | | | | | | | | | | | | | | | | | | | | | | | | | | | | | | | | | | | | | | | | | | | | | | | | | | | | | | | | | | | | | | | | | | | | | | | | | | | | | | | | | | | | | | | | | | | | | | | | | | | | | | | | | | | | | | | | | | | | | | | | | | | | | | | | | | | | | | | | | | | | | | | | | | | | | | | | | | | | | | | | | | | | |
| 1 | 3 | 5 | 7 | 9 | | | | | | | | | | | | | | | | | | | | | | | | | | | | | | | | | | | | | | | | | | | | | | | | | | | | | | | | | | | | | | | | | | | | | | | | | | | | | | | | | | | | | | | | | | | | | | | | | | | | | | | | | | | | | | | | | | | | | | | | | | | | | | | | | | | | | | | | | | | | | | | | | | | | | | | | | | | | | | | | | | | | | | | | | | | | | | | | | | | | | | | | | | | | | | | | | | | | | | | | | | | | | | | | | | | | | | | | | | | | | | | | | | | | | | | | | | | | | | | | | | | | | | | | | | | | | | | | | | | | | | | | | | | | | | | | | | | | | | | | | | | | | | | | | | | | | | | | | | | | | | | | | | | | | | | | | | | | | | | | | | | | | | | | | | | | | | | | | | | | | | | | | | | | | | | | | | | | | | | | | | | | | | | | | | | | | | | | | | | | | | | | | | | | | | | | | | | | | | | | | | | | | | | | | | | | | | | | | | | | | | | | | | | | | | | | | | | | | | | | | | | | | | | | | | | | | | | | | | | | | | | | | | | | | | | | | | | | | | | | | | | | | | | | | | | | | | | | | | | | | | | | | | | | | | | | | | | | | | | | | | | | | | | | | | | | | | | | | | | | | | | | | | | | | | | | | | | | | | | | | | | | | | | | | | | | | | | | | | | | | | | | | | | | | | | | | | | | | | | | | | | | |
| 2 | 0.1 | 0.2 | 0.4 | 0.6 | | | | | | | | | | | | | | | | | | | | | | | | | | | | | | | | | | | | | | | | | | | | | | | | | | | | | | | | | | | | | | | | | | | | | | | | | | | | | | | | | | | | | | | | | | | | | | | | | | | | | | | | | | | | | | | | | | | | | | | | | | | | | | | | | | | | | | | | | | | | | | | | | | | | | | | | | | | | | | | | | | | | | | | | | | | | | | | | | | | | | | | | | | | | | | | | | | | | | | | | | | | | | | | | | | | | | | | | | | | | | | | | | | | | | | | | | | | | | | | | | | | | | | | | | | | | | | | | | | | | | | | | | | | | | | | | | | | | | | | | | | | | | | | | | | | | | | | | | | | | | | | | | | | | | | | | | | | | | | | | | | | | | | | | | | | | | | | | | | | | | | | | | | | | | | | | | | | | | | | | | | | | | | | | | | | | | | | | | | | | | | | | | | | | | | | | | | | | | | | | | | | | | | | | | | | | | | | | | | | | | | | | | | | | | | | | | | | | | | | | | | | | | | | | | | | | | | | | | | | | | | | | | | | | | | | | | | | | | | | | | | | | | | | | | | | | | | | | | | | | | | | | | | | | | | | | | | | | | | | | | | | | | | | | | | | | | | | | | | | | | | | | | | | | | | | | | | | | | | | | | | | | | | | | | | | | | | | | | | | | | | | | | | | | | | | | | | | | | | | | | | | | |
| 4 | 0.5 | 0.9 | 1.4 | 2.0 | | | | | | | | | | | | | | | | | | | | | | | | | | | | | | | | | | | | | | | | | | | | | | | | | | | | | | | | | | | | | | | | | | | | | | | | | | | | | | | | | | | | | | | | | | | | | | | | | | | | | | | | | | | | | | | | | | | | | | | | | | | | | | | | | | | | | | | | | | | | | | | | | | | | | | | | | | | | | | | | | | | | | | | | | | | | | | | | | | | | | | | | | | | | | | | | | | | | | | | | | | | | | | | | | | | | | | | | | | | | | | | | | | | | | | | | | | | | | | | | | | | | | | | | | | | | | | | | | | | | | | | | | | | | | | | | | | | | | | | | | | | | | | | | | | | | | | | | | | | | | | | | | | | | | | | | | | | | | | | | | | | | | | | | | | | | | | | | | | | | | | | | | | | | | | | | | | | | | | | | | | | | | | | | | | | | | | | | | | | | | | | | | | | | | | | | | | | | | | | | | | | | | | | | | | | | | | | | | | | | | | | | | | | | | | | | | | | | | | | | | | | | | | | | | | | | | | | | | | | | | | | | | | | | | | | | | | | | | | | | | | | | | | | | | | | | | | | | | | | | | | | | | | | | | | | | | | | | | | | | | | | | | | | | | | | | | | | | | | | | | | | | | | | | | | | | | | | | | | | | | | | | | | | | | | | | | | | | | | | | | | | | | | | | | | | | | | | | | | | | | | | | |
| 6 | 0.9 | 1.6 | 2.2 | 2.9 | | | | | | | | | | | | | | | | | | | | | | | | | | | | | | | | | | | | | | | | | | | | | | | | | | | | | | | | | | | | | | | | | | | | | | | | | | | | | | | | | | | | | | | | | | | | | | | | | | | | | | | | | | | | | | | | | | | | | | | | | | | | | | | | | | | | | | | | | | | | | | | | | | | | | | | | | | | | | | | | | | | | | | | | | | | | | | | | | | | | | | | | | | | | | | | | | | | | | | | | | | | | | | | | | | | | | | | | | | | | | | | | | | | | | | | | | | | | | | | | | | | | | | | | | | | | | | | | | | | | | | | | | | | | | | | | | | | | | | | | | | | | | | | | | | | | | | | | | | | | | | | | | | | | | | | | | | | | | | | | | | | | | | | | | | | | | | | | | | | | | | | | | | | | | | | | | | | | | | | | | | | | | | | | | | | | | | | | | | | | | | | | | | | | | | | | | | | | | | | | | | | | | | | | | | | | | | | | | | | | | | | | | | | | | | | | | | | | | | | | | | | | | | | | | | | | | | | | | | | | | | | | | | | | | | | | | | | | | | | | | | | | | | | | | | | | | | | | | | | | | | | | | | | | | | | | | | | | | | | | | | | | | | | | | | | | | | | | | | | | | | | | | | | | | | | | | | | | | | | | | | | | | | | | | | | | | | | | | | | | | | | | | | | | | | | | | | | | | | | | | | | | |
| 8 | 1.4 | 2.1 | 2.8 | 3.5 | | | | | | | | | | | | | | | | | | | | | | | | | | | | | | | | | | | | | | | | | | | | | | | | | | | | | | | | | | | | | | | | | | | | | | | | | | | | | | | | | | | | | | | | | | | | | | | | | | | | | | | | | | | | | | | | | | | | | | | | | | | | | | | | | | | | | | | | | | | | | | | | | | | | | | | | | | | | | | | | | | | | | | | | | | | | | | | | | | | | | | | | | | | | | | | | | | | | | | | | | | | | | | | | | | | | | | | | | | | | | | | | | | | | | | | | | | | | | | | | | | | | | | | | | | | | | | | | | | | | | | | | | | | | | | | | | | | | | | | | | | | | | | | | | | | | | | | | | | | | | | | | | | | | | | | | | | | | | | | | | | | | | | | | | | | | | | | | | | | | | | | | | | | | | | | | | | | | | | | | | | | | | | | | | | | | | | | | | | | | | | | | | | | | | | | | | | | | | | | | | | | | | | | | | | | | | | | | | | | | | | | | | | | | | | | | | | | | | | | | | | | | | | | | | | | | | | | | | | | | | | | | | | | | | | | | | | | | | | | | | | | | | | | | | | | | | | | | | | | | | | | | | | | | | | | | | | | | | | | | | | | | | | | | | | | | | | | | | | | | | | | | | | | | | | | | | | | | | | | | | | | | | | | | | | | | | | | | | | | | | | | | | | | | | | | | | | | | | | | | | | | | |
| 10 | 2.0 | 2.7 | 3.4 | 4.1 | | | | | | | | | | | | | | | | | | | | | | | | | | | | | | | | | | | | | | | | | | | | | | | | | | | | | | | | | | | | | | | | | | | | | | | | | | | | | | | | | | | | | | | | | | | | | | | | | | | | | | | | | | | | | | | | | | | | | | | | | | | | | | | | | | | | | | | | | | | | | | | | | | | | | | | | | | | | | | | | | | | | | | | | | | | | | | | | | | | | | | | | | | | | | | | | | | | | | | | | | | | | | | | | | | | | | | | | | | | | | | | | | | | | | | | | | | | | | | | | | | | | | | | | | | | | | | | | | | | | | | | | | | | | | | | | | | | | | | | | | | | | | | | | | | | | | | | | | | | | | | | | | | | | | | | | | | | | | | | | | | | | | | | | | | | | | | | | | | | | | | | | | | | | | | | | | | | | | | | | | | | | | | | | | | | | | | | | | | | | | | | | | | | | | | | | | | | | | | | | | | | | | | | | | | | | | | | | | | | | | | | | | | | | | | | | | | | | | | | | | | | | | | | | | | | | | | | | | | | | | | | | | | | | | | | | | | | | | | | | | | | | | | | | | | | | | | | | | | | | | | | | | | | | | | | | | | | | | | | | | | | | | | | | | | | | | | | | | | | | | | | | | | | | | | | | | | | | | | | | | | | | | | | | | | | | | | | | | | | | | | | | | | | | | | | | | | | | | | | | | | | | |
| 1/2 ss | | | | | | | | | | | | | | | | | | | | | | | | | | | | | | | | | | | | | | | | | | | | | | | | | | | | | | | | | | | | | | | | | | | | | | | | | | | | | | | | | | | | | | | | | | | | | | | | | | | | | | | | | | | | | | | | | | | | | | | | | | | | | | | | | | | | | | | | | | | | | | | | | | | | | | | | | | | | | | | | | | | | | | | | | | | | | | | | | | | | | | | | | | | | | | | | | | | | | | | | | | | | | | | | | | | | | | | | | | | | | | | | | | | | | | | | | | | | | | | | | | | | | | | | | | | | | | | | | | | | | | | | | | | | | | | | | | | | | | | | | | | | | | | | | | | | | | | | | | | | | | | | | | | | | | | | | | | | | | | | | | | | | | | | | | | | | | | | | | | | | | | | | | | | | | | | | | | | | | | | | | | | | | | | | | | | | | | | | | | | | | | | | | | | | | | | | | | | | | | | | | | | | | | | | | | | | | | | | | | | | | | | | | | | | | | | | | | | | | | | | | | | | | | | | | | | | | | | | | | | | | | | | | | | | | | | | | | | | | | | | | | | | | | | | | | | | | | | | | | | | | | | | | | | | | | | | | | | | | | | | | | | | | | | | | | | | | | | | | | | | | | | | | | | | | | | | | | | | | | | | | | | | | | | | | | | | | | | | | | | | | | | | | | | | | | | | | | | | | | | | | | | | | | | |
| 1 | 3 | 5 | 7 | 9 | | | | | | | | | | | | | | | | | | | | | | | | | | | | | | | | | | | | | | | | | | | | | | | | | | | | | | | | | | | | | | | | | | | | | | | | | | | | | | | | | | | | | | | | | | | | | | | | | | | | | | | | | | | | | | | | | | | | | | | | | | | | | | | | | | | | | | | | | | | | | | | | | | | | | | | | | | | | | | | | | | | | | | | | | | | | | | | | | | | | | | | | | | | | | | | | | | | | | | | | | | | | | | | | | | | | | | | | | | | | | | | | | | | | | | | | | | | | | | | | | | | | | | | | | | | | | | | | | | | | | | | | | | | | | | | | | | | | | | | | | | | | | | | | | | | | | | | | | | | | | | | | | | | | | | | | | | | | | | | | | | | | | | | | | | | | | | | | | | | | | | | | | | | | | | | | | | | | | | | | | | | | | | | | | | | | | | | | | | | | | | | | | | | | | | | | | | | | | | | | | | | | | | | | | | | | | | | | | | | | | | | | | | | | | | | | | | | | | | | | | | | | | | | | | | | | | | | | | | | | | | | | | | | | | | | | | | | | | | | | | | | | | | | | | | | | | | | | | | | | | | | | | | | | | | | | | | | | | | | | | | | | | | | | | | | | | | | | | | | | | | | | | | | | | | | | | | | | | | | | | | | | | | | | | | | | | | | | | | | | | | | | | | | | | | | | | | | | | | | | | | | | |
| 1 | 0.3 | 0.5 | 0.9 | 1.3 | | | | | | | | | | | | | | | | | | | | | | | | | | | | | | | | | | | | | | | | | | | | | | | | | | | | | | | | | | | | | | | | | | | | | | | | | | | | | | | | | | | | | | | | | | | | | | | | | | | | | | | | | | | | | | | | | | | | | | | | | | | | | | | | | | | | | | | | | | | | | | | | | | | | | | | | | | | | | | | | | | | | | | | | | | | | | | | | | | | | | | | | | | | | | | | | | | | | | | | | | | | | | | | | | | | | | | | | | | | | | | | | | | | | | | | | | | | | | | | | | | | | | | | | | | | | | | | | | | | | | | | | | | | | | | | | | | | | | | | | | | | | | | | | | | | | | | | | | | | | | | | | | | | | | | | | | | | | | | | | | | | | | | | | | | | | | | | | | | | | | | | | | | | | | | | | | | | | | | | | | | | | | | | | | | | | | | | | | | | | | | | | | | | | | | | | | | | | | | | | | | | | | | | | | | | | | | | | | | | | | | | | | | | | | | | | | | | | | | | | | | | | | | | | | | | | | | | | | | | | | | | | | | | | | | | | | | | | | | | | | | | | | | | | | | | | | | | | | | | | | | | | | | | | | | | | | | | | | | | | | | | | | | | | | | | | | | | | | | | | | | | | | | | | | | | | | | | | | | | | | | | | | | | | | | | | | | | | | | | | | | | | | | | | | | | | | | | | | | | | | | | | |
| 3 | 0.8 | 1.4 | 2.0 | 2.6 | | | | | | | | | | | | | | | | | | | | | | | | | | | | | | | | | | | | | | | | | | | | | | | | | | | | | | | | | | | | | | | | | | | | | | | | | | | | | | | | | | | | | | | | | | | | | | | | | | | | | | | | | | | | | | | | | | | | | | | | | | | | | | | | | | | | | | | | | | | | | | | | | | | | | | | | | | | | | | | | | | | | | | | | | | | | | | | | | | | | | | | | | | | | | | | | | | | | | | | | | | | | | | | | | | | | | | | | | | | | | | | | | | | | | | | | | | | | | | | | | | | | | | | | | | | | | | | | | | | | | | | | | | | | | | | | | | | | | | | | | | | | | | | | | | | | | | | | | | | | | | | | | | | | | | | | | | | | | | | | | | | | | | | | | | | | | | | | | | | | | | | | | | | | | | | | | | | | | | | | | | | | | | | | | | | | | | | | | | | | | | | | | | | | | | | | | | | | | | | | | | | | | | | | | | | | | | | | | | | | | | | | | | | | | | | | | | | | | | | | | | | | | | | | | | | | | | | | | | | | | | | | | | | | | | | | | | | | | | | | | | | | | | | | | | | | | | | | | | | | | | | | | | | | | | | | | | | | | | | | | | | | | | | | | | | | | | | | | | | | | | | | | | | | | | | | | | | | | | | | | | | | | | | | | | | | | | | | | | | | | | | | | | | | | | | | | | | | | | | | | | | | |
| 5 | 1.3 | 2.0 | 2.7 | 3.4 | | | | | | | | | | | | | | | | | | | | | | | | | | | | | | | | | | | | | | | | | | | | | | | | | | | | | | | | | | | | | | | | | | | | | | | | | | | | | | | | | | | | | | | | | | | | | | | | | | | | | | | | | | | | | | | | | | | | | | | | | | | | | | | | | | | | | | | | | | | | | | | | | | | | | | | | | | | | | | | | | | | | | | | | | | | | | | | | | | | | | | | | | | | | | | | | | | | | | | | | | | | | | | | | | | | | | | | | | | | | | | | | | | | | | | | | | | | | | | | | | | | | | | | | | | | | | | | | | | | | | | | | | | | | | | | | | | | | | | | | | | | | | | | | | | | | | | | | | | | | | | | | | | | | | | | | | | | | | | | | | | | | | | | | | | | | | | | | | | | | | | | | | | | | | | | | | | | | | | | | | | | | | | | | | | | | | | | | | | | | | | | | | | | | | | | | | | | | | | | | | | | | | | | | | | | | | | | | | | | | | | | | | | | | | | | | | | | | | | | | | | | | | | | | | | | | | | | | | | | | | | | | | | | | | | | | | | | | | | | | | | | | | | | | | | | | | | | | | | | | | | | | | | | | | | | | | | | | | | | | | | | | | | | | | | | | | | | | | | | | | | | | | | | | | | | | | | | | | | | | | | | | | | | | | | | | | | | | | | | | | | | | | | | | | | | | | | | | | | | | | | | | |
| 7 | 1.9 | 2.6 | 3.3 | 4.0 | | | | | | | | | | | | | | | | | | | | | | | | | | | | | | | | | | | | | | | | | | | | | | | | | | | | | | | | | | | | | | | | | | | | | | | | | | | | | | | | | | | | | | | | | | | | | | | | | | | | | | | | | | | | | | | | | | | | | | | | | | | | | | | | | | | | | | | | | | | | | | | | | | | | | | | | | | | | | | | | | | | | | | | | | | | | | | | | | | | | | | | | | | | | | | | | | | | | | | | | | | | | | | | | | | | | | | | | | | | | | | | | | | | | | | | | | | | | | | | | | | | | | | | | | | | | | | | | | | | | | | | | | | | | | | | | | | | | | | | | | | | | | | | | | | | | | | | | | | | | | | | | | | | | | | | | | | | | | | | | | | | | | | | | | | | | | | | | | | | | | | | | | | | | | | | | | | | | | | | | | | | | | | | | | | | | | | | | | | | | | | | | | | | | | | | | | | | | | | | | | | | | | | | | | | | | | | | | | | | | | | | | | | | | | | | | | | | | | | | | | | | | | | | | | | | | | | | | | | | | | | | | | | | | | | | | | | | | | | | | | | | | | | | | | | | | | | | | | | | | | | | | | | | | | | | | | | | | | | | | | | | | | | | | | | | | | | | | | | | | | | | | | | | | | | | | | | | | | | | | | | | | | | | | | | | | | | | | | | | | | | | | | | | | | | | | | | | | | | | | | | | | |
| 1/2 ss | | | | | | | | | | | | | | | | | | | | | | | | | | | | | | | | | | | | | | | | | | | | | | | | | | | | | | | | | | | | | | | | | | | | | | | | | | | | | | | | | | | | | | | | | | | | | | | | | | | | | | | | | | | | | | | | | | | | | | | | | | | | | | | | | | | | | | | | | | | | | | | | | | | | | | | | | | | | | | | | | | | | | | | | | | | | | | | | | | | | | | | | | | | | | | | | | | | | | | | | | | | | | | | | | | | | | | | | | | | | | | | | | | | | | | | | | | | | | | | | | | | | | | | | | | | | | | | | | | | | | | | | | | | | | | | | | | | | | | | | | | | | | | | | | | | | | | | | | | | | | | | | | | | | | | | | | | | | | | | | | | | | | | | | | | | | | | | | | | | | | | | | | | | | | | | | | | | | | | | | | | | | | | | | | | | | | | | | | | | | | | | | | | | | | | | | | | | | | | | | | | | | | | | | | | | | | | | | | | | | | | | | | | | | | | | | | | | | | | | | | | | | | | | | | | | | | | | | | | | | | | | | | | | | | | | | | | | | | | | | | | | | | | | | | | | | | | | | | | | | | | | | | | | | | | | | | | | | | | | | | | | | | | | | | | | | | | | | | | | | | | | | | | | | | | | | | | | | | | | | | | | | | | | | | | | | | | | | | | | | | | | | | | | | | | | | | | | | | | | | | | | | | | | | |
| 1 | 3 | 5 | 7 | 9 | | | | | | | | | | | | | | | | | | | | | | | | | | | | | | | | | | | | | | | | | | | | | | | | | | | | | | | | | | | | | | | | | | | | | | | | | | | | | | | | | | | | | | | | | | | | | | | | | | | | | | | | | | | | | | | | | | | | | | | | | | | | | | | | | | | | | | | | | | | | | | | | | | | | | | | | | | | | | | | | | | | | | | | | | | | | | | | | | | | | | | | | | | | | | | | | | | | | | | | | | | | | | | | | | | | | | | | | | | | | | | | | | | | | | | | | | | | | | | | | | | | | | | | | | | | | | | | | | | | | | | | | | | | | | | | | | | | | | | | | | | | | | | | | | | | | | | | | | | | | | | | | | | | | | | | | | | | | | | | | | | | | | | | | | | | | | | | | | | | | | | | | | | | | | | | | | | | | | | | | | | | | | | | | | | | | | | | | | | | | | | | | | | | | | | | | | | | | | | | | | | | | | | | | | | | | | | | | | | | | | | | | | | | | | | | | | | | | | | | | | | | | | | | | | | | | | | | | | | | | | | | | | | | | | | | | | | | | | | | | | | | | | | | | | | | | | | | | | | | | | | | | | | | | | | | | | | | | | | | | | | | | | | | | | | | | | | | | | | | | | | | | | | | | | | | | | | | | | | | | | | | | | | | | | | | | | | | | | | | | | | | | | | | | | | | | | | | | | | | | | | | | |
| 0.2 | 0.4 | 0.7 | 1.0 | 1.5 | | | | | | | | | | | | | | | | | | | | | | | | | | | | | | | | | | | | | | | | | | | | | | | | | | | | | | | | | | | | | | | | | | | | | | | | | | | | | | | | | | | | | | | | | | | | | | | | | | | | | | | | | | | | | | | | | | | | | | | | | | | | | | | | | | | | | | | | | | | | | | | | | | | | | | | | | | | | | | | | | | | | | | | | | | | | | | | | | | | | | | | | | | | | | | | | | | | | | | | | | | | | | | | | | | | | | | | | | | | | | | | | | | | | | | | | | | | | | | | | | | | | | | | | | | | | | | | | | | | | | | | | | | | | | | | | | | | | | | | | | | | | | | | | | | | | | | | | | | | | | | | | | | | | | | | | | | | | | | | | | | | | | | | | | | | | | | | | | | | | | | | | | | | | | | | | | | | | | | | | | | | | | | | | | | | | | | | | | | | | | | | | | | | | | | | | | | | | | | | | | | | | | | | | | | | | | | | | | | | | | | | | | | | | | | | | | | | | | | | | | | | | | | | | | | | | | | | | | | | | | | | | | | | | | | | | | | | | | | | | | | | | | | | | | | | | | | | | | | | | | | | | | | | | | | | | | | | | | | | | | | | | | | | | | | | | | | | | | | | | | | | | | | | | | | | | | | | | | | | | | | | | | | | | | | | | | | | | | | | | | | | | | | | | | | | | | | | | | | | | | | | | |
| 1/2 ss | | | | | | | | | | | | | | | | | | | | | | | | | | | | | | | | | | | | | | | | | | | | | | | | | | | | | | | | | | | | | | | | | | | | | | | | | | | | | | | | | | | | | | | | | | | | | | | | | | | | | | | | | | | | | | | | | | | | | | | | | | | | | | | | | | | | | | | | | | | | | | | | | | | | | | | | | | | | | | | | | | | | | | | | | | | | | | | | | | | | | | | | | | | | | | | | | | | | | | | | | | | | | | | | | | | | | | | | | | | | | | | | | | | | | | | | | | | | | | | | | | | | | | | | | | | | | | | | | | | | | | | | | | | | | | | | | | | | | | | | | | | | | | | | | | | | | | | | | | | | | | | | | | | | | | | | | | | | | | | | | | | | | | | | | | | | | | | | | | | | | | | | | | | | | | | | | | | | | | | | | | | | | | | | | | | | | | | | | | | | | | | | | | | | | | | | | | | | | | | | | | | | | | | | | | | | | | | | | | | | | | | | | | | | | | | | | | | | | | | | | | | | | | | | | | | | | | | | | | | | | | | | | | | | | | | | | | | | | | | | | | | | | | | | | | | | | | | | | | | | | | | | | | | | | | | | | | | | | | | | | | | | | | | | | | | | | | | | | | | | | | | | | | | | | | | | | | | | | | | | | | | | | | | | | | | | | | | | | | | | | | | | | | | | | | | | | | | | | | | | | | | | | | | | |
| 1 | 3 | 5 | 7 | 9 | | | | | | | | | | | | | | | | | | | | | | | | | | | | | | | | | | | | | | | | | | | | | | | | | | | | | | | | | | | | | | | | | | | | | | | | | | | | | | | | | | | | | | | | | | | | | | | | | | | | | | | | | | | | | | | | | | | | | | | | | | | | | | | | | | | | | | | | | | | | | | | | | | | | | | | | | | | | | | | | | | | | | | | | | | | | | | | | | | | | | | | | | | | | | | | | | | | | | | | | | | | | | | | | | | | | | | | | | | | | | | | | | | | | | | | | | | | | | | | | | | | | | | | | | | | | | | | | | | | | | | | | | | | | | | | | | | | | | | | | | | | | | | | | | | | | | | | | | | | | | | | | | | | | | | | | | | | | | | | | | | | | | | | | | | | | | | | | | | | | | | | | | | | | | | | | | | | | | | | | | | | | | | | | | | | | | | | | | | | | | | | | | | | | | | | | | | | | | | | | | | | | | | | | | | | | | | | | | | | | | | | | | | | | | | | | | | | | | | | | | | | | | | | | | | | | | | | | | | | | | | | | | | | | | | | | | | | | | | | | | | | | | | | | | | | | | | | | | | | | | | | | | | | | | | | | | | | | | | | | | | | | | | | | | | | | | | | | | | | | | | | | | | | | | | | | | | | | | | | | | | | | | | | | | | | | | | | | | | | | | | | | | | | | | | | | | | | | | | | | | | | | |
| 2.4 | 2.7 | 3.2 | 4.2 | 5.7 | | | | | | | | | | | | | | | | | | | | | | | | | | | | | | | | | | | | | | | | | | | | | | | | | | | | | | | | | | | | | | | | | | | | | | | | | | | | | | | | | | | | | | | | | | | | | | | | | | | | | | | | | | | | | | | | | | | | | | | | | | | | | | | | | | | | | | | | | | | | | | | | | | | | | | | | | | | | | | | | | | | | | | | | | | | | | | | | | | | | | | | | | | | | | | | | | | | | | | | | | | | | | | | | | | | | | | | | | | | | | | | | | | | | | | | | | | | | | | | | | | | | | | | | | | | | | | | | | | | | | | | | | | | | | | | | | | | | | | | | | | | | | | | | | | | | | | | | | | | | | | | | | | | | | | | | | | | | | | | | | | | | | | | | | | | | | | | | | | | | | | | | | | | | | | | | | | | | | | | | | | | | | | | | | | | | | | | | | | | | | | | | | | | | | | | | | | | | | | | | | | | | | | | | | | | | | | | | | | | | | | | | | | | | | | | | | | | | | | | | | | | | | | | | | | | | | | | | | | | | | | | | | | | | | | | | | | | | | | | | | | | | | | | | | | | | | | | | | | | | | | | | | | | | | | | | | | | | | | | | | | | | | | | | | | | | | | | | | | | | | | | | | | | | | | | | | | | | | | | | | | | | | | | | | | | | | | | | | | | | | | | | | | | | | | | | | | | | | | | | | | | | |
| 1/2 ss | | | | | | | | | | | | | | | | | | | | | | | | | | | | | | | | | | | | | | | | | | | | | | | | | | | | | | | | | | | | | | | | | | | | | | | | | | | | | | | | | | | | | | | | | | | | | | | | | | | | | | | | | | | | | | | | | | | | | | | | | | | | | | | | | | | | | | | | | | | | | | | | | | | | | | | | | | | | | | | | | | | | | | | | | | | | | | | | | | | | | | | | | | | | | | | | | | | | | | | | | | | | | | | | | | | | | | | | | | | | | | | | | | | | | | | | | | | | | | | | | | | | | | | | | | | | | | | | | | | | | | | | | | | | | | | | | | | | | | | | | | | | | | | | | | | | | | | | | | | | | | | | | | | | | | | | | | | | | | | | | | | | | | | | | | | | | | | | | | | | | | | | | | | | | | | | | | | | | | | | | | | | | | | | | | | | | | | | | | | | | | | | | | | | | | | | | | | | | | | | | | | | | | | | | | | | | | | | | | | | | | | | | | | | | | | | | | | | | | | | | | | | | | | | | | | | | | | | | | | | | | | | | | | | | | | | | | | | | | | | | | | | | | | | | | | | | | | | | | | | | | | | | | | | | | | | | | | | | | | | | | | | | | | | | | | | | | | | | | | | | | | | | | | | | | | | | | | | | | | | | | | | | | | | | | | | | | | | | | | | | | | | | | | | | | | | | | | | | | | | | | | | | | | | |
| 1 | 3 | 5 | 7 | 9 | | | | | | | | | | | | | | | | | | | | | | | | | | | | | | | | | | | | | | | | | | | | | | | | | | | | | | | | | | | | | | | | | | | | | | | | | | | | | | | | | | | | | | | | | | | | | | | | | | | | | | | | | | | | | | | | | | | | | | | | | | | | | | | | | | | | | | | | | | | | | | | | | | | | | | | | | | | | | | | | | | | | | | | | | | | | | | | | | | | | | | | | | | | | | | | | | | | | | | | | | | | | | | | | | | | | | | | | | | | | | | | | | | | | | | | | | | | | | | | | | | | | | | | | | | | | | | | | | | | | | | | | | | | | | | | | | | | | | | | | | | | | | | | | | | | | | | | | | | | | | | | | | | | | | | | | | | | | | | | | | | | | | | | | | | | | | | | | | | | | | | | | | | | | | | | | | | | | | | | | | | | | | | | | | | | | | | | | | | | | | | | | | | | | | | | | | | | | | | | | | | | | | | | | | | | | | | | | | | | | | | | | | | | | | | | | | | | | | | | | | | | | | | | | | | | | | | | | | | | | | | | | | | | | | | | | | | | | | | | | | | | | | | | | | | | | | | | | | | | | | | | | | | | | | | | | | | | | | | | | | | | | | | | | | | | | | | | | | | | | | | | | | | | | | | | | | | | | | | | | | | | | | | | | | | | | | | | | | | | | | | | | | | | | | | | | | | | | | | | | | | | | |
| 0.1 | 0.3 | 0.5 | 0.8 | 1.1 | | | | | | | | | | | | | | | | | | | | | | | | | | | | | | | | | | | | | | | | | | | | | | | | | | | | | | | | | | | | | | | | | | | | | | | | | | | | | | | | | | | | | | | | | | | | | | | | | | | | | | | | | | | | | | | | | | | | | | | | | | | | | | | | | | | | | | | | | | | | | | | | | | | | | | | | | | | | | | | | | | | | | | | | | | | | | | | | | | | | | | | | | | | | | | | | | | | | | | | | | | | | | | | | | | | | | | | | | | | | | | | | | | | | | | | | | | | | | | | | | | | | | | | | | | | | | | | | | | | | | | | | | | | | | | | | | | | | | | | | | | | | | | | | | | | | | | | | | | | | | | | | | | | | | | | | | | | | | | | | | | | | | | | | | | | | | | | | | | | | | | | | | | | | | | | | | | | | | | | | | | | | | | | | | | | | | | | | | | | | | | | | | | | | | | | | | | | | | | | | | | | | | | | | | | | | | | | | | | | | | | | | | | | | | | | | | | | | | | | | | | | | | | | | | | | | | | | | | | | | | | | | | | | | | | | | | | | | | | | | | | | | | | | | | | | | | | | | | | | | | | | | | | | | | | | | | | | | | | | | | | | | | | | | | | | | | | | | | | | | | | | | | | | | | | | | | | | | | | | | | | | | | | | | | | | | | | | | | | | | | | | | | | | | | | | | | | | | | | | | | | | | |
| 1/2 ss | | | | | | | | | | | | | | | | | | | | | | | | | | | | | | | | | | | | | | | | | | | | | | | | | | | | | | | | | | | | | | | | | | | | | | | | | | | | | | | | | | | | | | | | | | | | | | | | | | | | | | | | | | | | | | | | | | | | | | | | | | | | | | | | | | | | | | | | | | | | | | | | | | | | | | | | | | | | | | | | | | | | | | | | | | | | | | | | | | | | | | | | | | | | | | | | | | | | | | | | | | | | | | | | | | | | | | | | | | | | | | | | | | | | | | | | | | | | | | | | | | | | | | | | | | | | | | | | | | | | | | | | | | | | | | | | | | | | | | | | | | | | | | | | | | | | | | | | | | | | | | | | | | | | | | | | | | | | | | | | | | | | | | | | | | | | | | | | | | | | | | | | | | | | | | | | | | | | | | | | | | | | | | | | | | | | | | | | | | | | | | | | | | | | | | | | | | | | | | | | | | | | | | | | | | | | | | | | | | | | | | | | | | | | | | | | | | | | | | | | | | | | | | | | | | | | | | | | | | | | | | | | | | | | | | | | | | | | | | | | | | | | | | | | | | | | | | | | | | | | | | | | | | | | | | | | | | | | | | | | | | | | | | | | | | | | | | | | | | | | | | | | | | | | | | | | | | | | | | | | | | | | | | | | | | | | | | | | | | | | | | | | | | | | | | | | | | | | | | | | | | | | | | | | |
| 1 | 3 | 5 | 7 | 9 | | | | | | | | | | | | | | | | | | | | | | | | | | | | | | | | | | | | | | | | | | | | | | | | | | | | | | | | | | | | | | | | | | | | | | | | | | | | | | | | | | | | | | | | | | | | | | | | | | | | | | | | | | | | | | | | | | | | | | | | | | | | | | | | | | | | | | | | | | | | | | | | | | | | | | | | | | | | | | | | | | | | | | | | | | | | | | | | | | | | | | | | | | | | | | | | | | | | | | | | | | | | | | | | | | | | | | | | | | | | | | | | | | | | | | | | | | | | | | | | | | | | | | | | | | | | | | | | | | | | | | | | | | | | | | | | | | | | | | | | | | | | | | | | | | | | | | | | | | | | | | | | | | | | | | | | | | | | | | | | | | | | | | | | | | | | | | | | | | | | | | | | | | | | | | | | | | | | | | | | | | | | | | | | | | | | | | | | | | | | | | | | | | | | | | | | | | | | | | | | | | | | | | | | | | | | | | | | | | | | | | | | | | | | | | | | | | | | | | | | | | | | | | | | | | | | | | | | | | | | | | | | | | | | | | | | | | | | | | | | | | | | | | | | | | | | | | | | | | | | | | | | | | | | | | | | | | | | | | | | | | | | | | | | | | | | | | | | | | | | | | | | | | | | | | | | | | | | | | | | | | | | | | | | | | | | | | | | | | | | | | | | | | | | | | | | | | | | | | | | | | | | |
| 2.4 | 2.7 | 3.2 | 4.2 | 5.7 | | | | | | | | | | | | | | | | | | | | | | | | | | | | | | | | | | | | | | | | | | | | | | | | | | | | | | | | | | | | | | | | | | | | | | | | | | | | | | | | | | | | | | | | | | | | | | | | | | | | | | | | | | | | | | | | | | | | | | | | | | | | | | | | | | | | | | | | | | | | | | | | | | | | | | | | | | | | | | | | | | | | | | | | | | | | | | | | | | | | | | | | | | | | | | | | | | | | | | | | | | | | | | | | | | | | | | | | | | | | | | | | | | | | | | | | | | | | | | | | | | | | | | | | | | | | | | | | | | | | | | | | | | | | | | | | | | | | | | | | | | | | | | | | | | | | | | | | | | | | | | | | | | | | | | | | | | | | | | | | | | | | | | | | | | | | | | | | | | | | | | | | | | | | | | | | | | | | | | | | | | | | | | | | | | | | | | | | | | | | | | | | | | | | | | | | | | | | | | | | | | | | | | | | | | | | | | | | | | | | | | | | | | | | | | | | | | | | | | | | | | | | | | | | | | | | | | | | | | | | | | | | | | | | | | | | | | | | | | | | | | | | | | | | | | | | | | | | | | | | | | | | | | | | | | | | | | | | | | | | | | | | | | | | | | | | | | | | | | | | | | | | | | | | | | | | | | | | | | | | | | | | | | | | | | | | | | | | | | | | | | | | | | | | | | | | | | | | | | | | | | | | |
| 1/2 ss | | | | | | | | | | | | | | | | | | | | | | | | | | | | | | | | | | | | | | | | | | | | | | | | | | | | | | | | | | | | | | | | | | | | | | | | | | | | | | | | | | | | | | | | | | | | | | | | | | | | | | | | | | | | | | | | | | | | | | | | | | | | | | | | | | | | | | | | | | | | | | | | | | | | | | | | | | | | | | | | | | | | | | | | | | | | | | | | | | | | | | | | | | | | | | | | | | | | | | | | | | | | | | | | | | | | | | | | | | | | | | | | | | | | | | | | | | | | | | | | | | | | | | | | | | | | | | | | | | | | | | | | | | | | | | | | | | | | | | | | | | | | | | | | | | | | | | | | | | | | | | | | | | | | | | | | | | | | | | | | | | | | | | | | | | | | | | | | | | | | | | | | | | | | | | | | | | | | | | | | | | | | | | | | | | | | | | | | | | | | | | | | | | | | | | | | | | | | | | | | | | | | | | | | | | | | | | | | | | | | | | | | | | | | | | | | | | | | | | | | | | | | | | | | | | | | | | | | | | | | | | | | | | | | | | | | | | | | | | | | | | | | | | | | | | | | | | | | | | | | | | | | | | | | | | | | | | | | | | | | | | | | | | | | | | | | | | | | | | | | | | | | | | | | | | | | | | | | | | | | | | | | | | | | | | | | | | | | | | | | | | | | | | | | | | | | | | | | | | | | | | | | | | | | |
| 1 | 3 | 5 | 7 | 9 | | | | | | | | | | | | | | | | | | | | | | | | | | | | | | | | | | | | | | | | | | | | | | | | | | | | | | | | | | | | | | | | | | | | | | | | | | | | | | | | | | | | | | | | | | | | | | | | | | | | | | | | | | | | | | | | | | | | | | | | | | | | | | | | | | | | | | | | | | | | | | | | | | | | | | | | | | | | | | | | | | | | | | | | | | | | | | | | | | | | | | | | | | | | | | | | | | | | | | | | | | | | | | | | | | | | | | | | | | | | | | | | | | | | | | | | | | | | | | | | | | | | | | | | | | | | | | | | | | | | | | | | | | | | | | | | | | | | | | | | | | | | | | | | | | | | | | | | | | | | | | | | | | | | | | | | | | | | | | | | | | | | | | | | | | | | | | | | | | | | | | | | | | | | | | | | | | | | | | | | | | | | | | | | | | | | | | | | | | | | | | | | | | | | | | | | | | | | | | | | | | | | | | | | | | | | | | | | | | | | | | | | | | | | | | | | | | | | | | | | | | | | | | | | | | | | | | | | | | | | | | | | | | | | | | | | | | | | | | | | | | | | | | | | | | | | | | | | | | | | | | | | | | | | | | | | | | | | | | | | | | | | | | | | | | | | | | | | | | | | | | | | | | | | | | | | | | | | | | | | | | | | | | | | | | | | | | | | | | | | | | | | | | | | | | | | | | | | | | | | | | | | |
| 0.1 | 0.3 | 0.5 | 0.8 | 1.1 | | | | | | | | | | | | | | | | | | | | | | | | | | | | | | | | | | | | | | | | | | | | | | | | | | | | | | | | | | | | | | | | | | | | | | | | | | | | | | | | | | | | | | | | | | | | | | | | | | | | | | | | | | | | | | | | | | | | | | | | | | | | | | | | | | | | | | | | | | | | | | | | | | | | | | | | | | | | | | | | | | | | | | | | | | | | | | | | | | | | | | | | | | | | | | | | | | | | | | | | | | | | | | | | | | | | | | | | | | | | | | | | | | | | | | | | | | | | | | | | | | | | | | | | | | | | | | | | | | | | | | | | | | | | | | | | | | | | | | | | | | | | | | | | | | | | | | | | | | | | | | | | | | | | | | | | | | | | | | | | | | | | | | | | | | | | | | | | | | | | | | | | | | | | | | | | | | | | | | | | | | | | | | | | | | | | | | | | | | | | | | | | | | | | | | | | | | | | | | | | | | | | | | | | | | | | | | | | | | | | | | | | | | | | | | | | | | | | | | | | | | | | | | | | | | | | | | | | | | | | | | | | | | | | | | | | | | | | | | | | | | | | | | | | | | | | | | | | | | | | | | | | | | | | | | | | | | | | | | | | | | | | | | | | | | | | | | | | | | | | | | | | | | | | | | | | | | | | | | | | | | | | | | | | | | | | | | | | | | | | | | | | | | | | | | | | | | | | | | | | | | | | |
| 1/2 ss | | | | | | | | | | | | | | | | | | | | | | | | | | | | | | | | | | | | | | | | | | | | | | | | | | | | | | | | | | | | | | | | | | | | | | | | | | | | | | | | | | | | | | | | | | | | | | | | | | | | | | | | | | | | | | | | | | | | | | | | | | | | | | | | | | | | | | | | | | | | | | | | | | | | | | | | | | | | | | | | | | | | | | | | | | | | | | | | | | | | | | | | | | | | | | | | | | | | | | | | | | | | | | | | | | | | | | | | | | | | | | | | | | | | | | | | | | | | | | | | | | | | | | | | | | | | | | | | | | | | | | | | | | | | | | | | | | | | | | | | | | | | | | | | | | | | | | | | | | | | | | | | | | | | | | | | | | | | | | | | | | | | | | | | | | | | | | | | | | | | | | | | | | | | | | | | | | | | | | | | | | | | | | | | | | | | | | | | | | | | | | | | | | | | | | | | | | | | | | | | | | | | | | | | | | | | | | | | | | | | | | | | | | | | | | | | | | | | | | | | | | | | | | | | | | | | | | | | | | | | | | | | | | | | | | | | | | | | | | | | | | | | | | | | | | | | | | | | | | | | | | | | | | | | | | | | | | | | | | | | | | | | | | | | | | | | | | | | | | | | | | | | | | | | | | | | | | | | | | | | | | | | | | | | | | | | | | | | | | | | | | | | | | | | | | | | | | | | | | | | | | | | | | | | |
| 1 | 3 | 5 | 7 | 9 | | | | | | | | | | | | | | | | | | | | | | | | | | | | | | | | | | | | | | | | | | | | | | | | | | | | | | | | | | | | | | | | | | | | | | | | | | | | | | | | | | | | | | | | | | | | | | | | | | | | | | | | | | | | | | | | | | | | | | | | | | | | | | | | | | | | | | | | | | | | | | | | | | | | | | | | | | | | | | | | | | | | | | | | | | | | | | | | | | | | | | | | | | | | | | | | | | | | | | | | | | | | | | | | | | | | | | | | | | | | | | | | | | | | | | | | | | | | | | | | | | | | | | | | | | | | | | | | | | | | | | | | | | | | | | | | | | | | | | | | | | | | | | | | | | | | | | | | | | | | | | | | | | | | | | | | | | | | | | | | | | | | | | | | | | | | | | | | | | | | | | | | | | | | | | | | | | | | | | | | | | | | | | | | | | | | | | | | | | | | | | | | | | | | | | | | | | | | | | | | | | | | | | | | | | | | | | | | | | | | | | | | | | | | | | | | | | | | | | | | | | | | | | | | | | | | | | | | | | | | | | | | | | | | | | | | | | | | | | | | | | | | | | | | | | | | | | | | | | | | | | | | | | | | | | | | | | | | | | | | | | | | | | | | | | | | | | | | | | | | | | | | | | | | | | | | | | | | | | | | | | | | | | | | | | | | | | | | | | | | | | | | | | | | | | | | | | | | | | | | | | | | |
| 0.2 | 0.4 | 0.6 | 0.8 | 1.0 | | | | | | | | | | | | | | | | | | | | | | | | | | | | | | | | | | | | | | | | | | | | | | | | | | | | | | | | | | | | | | | | | | | | | | | | | | | | | | | | | | | | | | | | | | | | | | | | | | | | | | | | | | | | | | | | | | | | | | | | | | | | | | | | | | | | | | | | | | | | | | | | | | | | | | | | | | | | | | | | | | | | | | | | | | | | | | | | | | | | | | | | | | | | | | | | | | | | | | | | | | | | | | | | | | | | | | | | | | | | | | | | | | | | | | | | | | | | | | | | | | | | | | | | | | | | | | | | | | | | | | | | | | | | | | | | | | | | | | | | | | | | | | | | | | | | | | | | | | | | | | | | | | | | | | | | | | | | | | | | | | | | | | | | | | | | | | | | | | | | | | | | | | | | | | | | | | | | | | | | | | | | | | | | | | | | | | | | | | | | | | | | | | | | | | | | | | | | | | | | | | | | | | | | | | | | | | | | | | | | | | | | | | | | | | | | | | | | | | | | | | | | | | | | | | | | | | | | | | | | | | | | | | | | | | | | | | | | | | | | | | | | | | | | | | | | | | | | | | | | | | | | | | | | | | | | | | | | | | | | | | | | | | | | | | | | | | | | | | | | | | | | | | | | | | | | | | | | | | | | | | | | | | | | | | | | | | | | | | | | | | | | | | | | | | | | | | | | | | | | | | | | |

HIGH DIVING: 20 METRES

| STANDING DIVES A+B+C+D+E+F+DD | | ARMSTAND DIVES A1+B1+C1+D1+E1+F1=DD | | | | | | | | | | | | | | | | | | | | | | | | | | | | | | | |
|----------------------------------|--|--|-----|-----|---|----|-----|-----|-----|-----|-----|---|-----|-----|-----|-----|---|-----|-----|-----|-----|---|-----|-----|-----|-----|----|-----|-----|-----|-----|--|--|
| FORWARD (GROUP 1) | | | | | | | | | | | | | | | | | | | | | | | | | | | | | | | | | |
| 1 - 51 | | | | | | | | | | | | | | | | | | | | | | | | | | | | | | | | | |
| A. SOMERSAULTS | <table border="1"><tr><td>1/2</td><td>3</td><td>5</td><td>8</td><td>10</td></tr><tr><td>2.5</td><td>2.8</td><td>3.4</td><td>4.4</td><td>5.9</td></tr></table> | 1/2 | 3 | 5 | 8 | 10 | 2.5 | 2.8 | 3.4 | 4.4 | 5.9 | | | | | | | | | | | | | | | | | | | | | | |
| 1/2 | 3 | 5 | 8 | 10 | | | | | | | | | | | | | | | | | | | | | | | | | | | | | |
| 2.5 | 2.8 | 3.4 | 4.4 | 5.9 | | | | | | | | | | | | | | | | | | | | | | | | | | | | | |
| B. APPROACH | <table border="1"><tr><td>2</td><td>4</td><td>6</td><td>8</td><td>10</td></tr><tr><td>0.0</td><td>0.0</td><td>0.0</td><td>0.0</td><td>0.0</td></tr></table> | 2 | 4 | 6 | 8 | 10 | 0.0 | 0.0 | 0.0 | 0.0 | 0.0 | | | | | | | | | | | | | | | | | | | | | | |
| 2 | 4 | 6 | 8 | 10 | | | | | | | | | | | | | | | | | | | | | | | | | | | | | |
| 0.0 | 0.0 | 0.0 | 0.0 | 0.0 | | | | | | | | | | | | | | | | | | | | | | | | | | | | | |
| C. TWISTS BARANI ENTRY | <table border="1"><tr><td>1/2</td><td>3</td><td>5</td><td>8</td><td>10</td></tr><tr><td>1</td><td>0.0</td><td>0.0</td><td>0.0</td><td>0.0</td></tr><tr><td>3</td><td>0.2</td><td>0.3</td><td>0.5</td><td>0.7</td></tr><tr><td>5</td><td>0.5</td><td>0.7</td><td>1.1</td><td>1.5</td></tr><tr><td>7</td><td>0.9</td><td>1.2</td><td>1.8</td><td>2.4</td></tr><tr><td>9</td><td>1.4</td><td>1.8</td><td>2.6</td><td>3.4</td></tr></table> | 1/2 | 3 | 5 | 8 | 10 | 1 | 0.0 | 0.0 | 0.0 | 0.0 | 3 | 0.2 | 0.3 | 0.5 | 0.7 | 5 | 0.5 | 0.7 | 1.1 | 1.5 | 7 | 0.9 | 1.2 | 1.8 | 2.4 | 9 | 1.4 | 1.8 | 2.6 | 3.4 | | |
| 1/2 | 3 | 5 | 8 | 10 | | | | | | | | | | | | | | | | | | | | | | | | | | | | | |
| 1 | 0.0 | 0.0 | 0.0 | 0.0 | | | | | | | | | | | | | | | | | | | | | | | | | | | | | |
| 3 | 0.2 | 0.3 | 0.5 | 0.7 | | | | | | | | | | | | | | | | | | | | | | | | | | | | | |
| 5 | 0.5 | 0.7 | 1.1 | 1.5 | | | | | | | | | | | | | | | | | | | | | | | | | | | | | |
| 7 | 0.9 | 1.2 | 1.8 | 2.4 | | | | | | | | | | | | | | | | | | | | | | | | | | | | | |
| 9 | 1.4 | 1.8 | 2.6 | 3.4 | | | | | | | | | | | | | | | | | | | | | | | | | | | | | |
| D. TWISTS BLIND ENTRY | <table border="1"><tr><td>1/2</td><td>3</td><td>5</td><td>8</td><td>10</td></tr><tr><td>2</td><td>0.4</td><td>0.6</td><td>0.9</td><td>1.3</td></tr><tr><td>4</td><td>1.1</td><td>1.6</td><td>2.2</td><td>2.8</td></tr><tr><td>6</td><td>1.7</td><td>2.4</td><td>3.2</td><td>4.0</td></tr><tr><td>8</td><td>2.5</td><td>3.3</td><td>4.2</td><td>5.2</td></tr></table> | 1/2 | 3 | 5 | 8 | 10 | 2 | 0.4 | 0.6 | 0.9 | 1.3 | 4 | 1.1 | 1.6 | 2.2 | 2.8 | 6 | 1.7 | 2.4 | 3.2 | 4.0 | 8 | 2.5 | 3.3 | 4.2 | 5.2 | | | | | | | |
| 1/2 | 3 | 5 | 8 | 10 | | | | | | | | | | | | | | | | | | | | | | | | | | | | | |
| 2 | 0.4 | 0.6 | 0.9 | 1.3 | | | | | | | | | | | | | | | | | | | | | | | | | | | | | |
| 4 | 1.1 | 1.6 | 2.2 | 2.8 | | | | | | | | | | | | | | | | | | | | | | | | | | | | | |
| 6 | 1.7 | 2.4 | 3.2 | 4.0 | | | | | | | | | | | | | | | | | | | | | | | | | | | | | |
| 8 | 2.5 | 3.3 | 4.2 | 5.2 | | | | | | | | | | | | | | | | | | | | | | | | | | | | | |
| E. BLIND ENTRY | <table border="1"><tr><td>2</td><td>4</td><td>6</td><td>8</td><td>10</td></tr><tr><td>0.2</td><td>0.3</td><td>0.4</td><td>0.6</td><td>0.8</td></tr></table> | 2 | 4 | 6 | 8 | 10 | 0.2 | 0.3 | 0.4 | 0.6 | 0.8 | | | | | | | | | | | | | | | | | | | | | | |
| 2 | 4 | 6 | 8 | 10 | | | | | | | | | | | | | | | | | | | | | | | | | | | | | |
| 0.2 | 0.3 | 0.4 | 0.6 | 0.8 | | | | | | | | | | | | | | | | | | | | | | | | | | | | | |
| BACK (GROUP 2) | | | | | | | | | | | | | | | | | | | | | | | | | | | | | | | | | |
| 2 - 52 | | | | | | | | | | | | | | | | | | | | | | | | | | | | | | | | | |
| A. SOMERSAULTS | <table border="1"><tr><td>1/2</td><td>3</td><td>5</td><td>8</td><td>10</td></tr><tr><td>2.5</td><td>2.8</td><td>3.4</td><td>4.4</td><td>5.9</td></tr></table> | 1/2 | 3 | 5 | 8 | 10 | 2.5 | 2.8 | 3.4 | 4.4 | 5.9 | | | | | | | | | | | | | | | | | | | | | | |
| 1/2 | 3 | 5 | 8 | 10 | | | | | | | | | | | | | | | | | | | | | | | | | | | | | |
| 2.5 | 2.8 | 3.4 | 4.4 | 5.9 | | | | | | | | | | | | | | | | | | | | | | | | | | | | | |
| B. APPROACH | <table border="1"><tr><td>2</td><td>4</td><td>6</td><td>8</td><td>10</td></tr><tr><td>0.2</td><td>0.3</td><td>0.4</td><td>0.5</td><td>0.6</td></tr></table> | 2 | 4 | 6 | 8 | 10 | 0.2 | 0.3 | 0.4 | 0.5 | 0.6 | | | | | | | | | | | | | | | | | | | | | | |
| 2 | 4 | 6 | 8 | 10 | | | | | | | | | | | | | | | | | | | | | | | | | | | | | |
| 0.2 | 0.3 | 0.4 | 0.5 | 0.6 | | | | | | | | | | | | | | | | | | | | | | | | | | | | | |
| C. TWISTS | <table border="1"><tr><td>1/2</td><td>3</td><td>5</td><td>8</td><td>10</td></tr><tr><td>2</td><td>0.0</td><td>0.0</td><td>0.0</td><td>0.0</td></tr><tr><td>4</td><td>0.2</td><td>0.3</td><td>0.5</td><td>0.7</td></tr><tr><td>6</td><td>0.5</td><td>0.7</td><td>1.1</td><td>1.5</td></tr><tr><td>8</td><td>0.9</td><td>1.3</td><td>1.9</td><td>2.5</td></tr><tr><td>10</td><td>1.5</td><td>2.1</td><td>2.9</td><td>3.7</td></tr></table> | 1/2 | 3 | 5 | 8 | 10 | 2 | 0.0 | 0.0 | 0.0 | 0.0 | 4 | 0.2 | 0.3 | 0.5 | 0.7 | 6 | 0.5 | 0.7 | 1.1 | 1.5 | 8 | 0.9 | 1.3 | 1.9 | 2.5 | 10 | 1.5 | 2.1 | 2.9 | 3.7 | | |
| 1/2 | 3 | 5 | 8 | 10 | | | | | | | | | | | | | | | | | | | | | | | | | | | | | |
| 2 | 0.0 | 0.0 | 0.0 | 0.0 | | | | | | | | | | | | | | | | | | | | | | | | | | | | | |
| 4 | 0.2 | 0.3 | 0.5 | 0.7 | | | | | | | | | | | | | | | | | | | | | | | | | | | | | |
| 6 | 0.5 | 0.7 | 1.1 | 1.5 | | | | | | | | | | | | | | | | | | | | | | | | | | | | | |
| 8 | 0.9 | 1.3 | 1.9 | 2.5 | | | | | | | | | | | | | | | | | | | | | | | | | | | | | |
| 10 | 1.5 | 2.1 | 2.9 | 3.7 | | | | | | | | | | | | | | | | | | | | | | | | | | | | | |
| D. TWISTS BLIND ENTRY | <table border="1"><tr><td>1/2</td><td>3</td><td>5</td><td>8</td><td>10</td></tr><tr><td>1</td><td>0.2</td><td>0.3</td><td>0.5</td><td>0.7</td></tr><tr><td>3</td><td>0.6</td><td>1.0</td><td>1.4</td><td>1.8</td></tr><tr><td>5</td><td>1.1</td><td>1.7</td><td>2.3</td><td>2.9</td></tr><tr><td>7</td><td>1.7</td><td>2.5</td><td>3.3</td><td>4.1</td></tr><tr><td>9</td><td>2.4</td><td>3.4</td><td>4.4</td><td>5.4</td></tr></table> | 1/2 | 3 | 5 | 8 | 10 | 1 | 0.2 | 0.3 | 0.5 | 0.7 | 3 | 0.6 | 1.0 | 1.4 | 1.8 | 5 | 1.1 | 1.7 | 2.3 | 2.9 | 7 | 1.7 | 2.5 | 3.3 | 4.1 | 9 | 2.4 | 3.4 | 4.4 | 5.4 | | |
| 1/2 | 3 | 5 | 8 | 10 | | | | | | | | | | | | | | | | | | | | | | | | | | | | | |
| 1 | 0.2 | 0.3 | 0.5 | 0.7 | | | | | | | | | | | | | | | | | | | | | | | | | | | | | |
| 3 | 0.6 | 1.0 | 1.4 | 1.8 | | | | | | | | | | | | | | | | | | | | | | | | | | | | | |
| 5 | 1.1 | 1.7 | 2.3 | 2.9 | | | | | | | | | | | | | | | | | | | | | | | | | | | | | |
| 7 | 1.7 | 2.5 | 3.3 | 4.1 | | | | | | | | | | | | | | | | | | | | | | | | | | | | | |
| 9 | 2.4 | 3.4 | 4.4 | 5.4 | | | | | | | | | | | | | | | | | | | | | | | | | | | | | |
| F. BACK ROTATION CONTROL ENTRY | <table border="1"><tr><td>2</td><td>4</td><td>6</td><td>8</td><td>10</td></tr><tr><td>0.0</td><td>0.1</td><td>0.2</td><td>0.3</td><td>0.5</td></tr></table> | 2 | 4 | 6 | 8 | 10 | 0.0 | 0.1 | 0.2 | 0.3 | 0.5 | | | | | | | | | | | | | | | | | | | | | | |
| 2 | 4 | 6 | 8 | 10 | | | | | | | | | | | | | | | | | | | | | | | | | | | | | |
| 0.0 | 0.1 | 0.2 | 0.3 | 0.5 | | | | | | | | | | | | | | | | | | | | | | | | | | | | | |
| FORWARD (GROUP 5) | | | | | | | | | | | | | | | | | | | | | | | | | | | | | | | | | |
| 61 | | | | | | | | | | | | | | | | | | | | | | | | | | | | | | | | | |
| A1. SOMERSAULTS | <table border="1"><tr><td>1</td><td>3</td><td>5</td><td>7</td><td>9</td></tr><tr><td>2.5</td><td>2.8</td><td>3.4</td><td>4.4</td><td>5.9</td></tr></table> | 1 | 3 | 5 | 7 | 9 | 2.5 | 2.8 | 3.4 | 4.4 | 5.9 | | | | | | | | | | | | | | | | | | | | | | |
| 1 | 3 | 5 | 7 | 9 | | | | | | | | | | | | | | | | | | | | | | | | | | | | | |
| 2.5 | 2.8 | 3.4 | 4.4 | 5.9 | | | | | | | | | | | | | | | | | | | | | | | | | | | | | |
| B1. APPROACH | <table border="1"><tr><td>1</td><td>3</td><td>5</td><td>7</td><td>9</td></tr><tr><td>0.0</td><td>0.1</td><td>0.3</td><td>0.5</td><td>0.7</td></tr></table> | 1 | 3 | 5 | 7 | 9 | 0.0 | 0.1 | 0.3 | 0.5 | 0.7 | | | | | | | | | | | | | | | | | | | | | | |
| 1 | 3 | 5 | 7 | 9 | | | | | | | | | | | | | | | | | | | | | | | | | | | | | |
| 0.0 | 0.1 | 0.3 | 0.5 | 0.7 | | | | | | | | | | | | | | | | | | | | | | | | | | | | | |
| C1. TWISTS BARANI ENTRY | <table border="1"><tr><td>1/2</td><td>3</td><td>5</td><td>7</td><td>9</td></tr><tr><td>1</td><td>0.0</td><td>0.0</td><td>0.0</td><td>0.0</td></tr><tr><td>3</td><td>0.2</td><td>0.3</td><td>0.4</td><td>0.6</td></tr><tr><td>5</td><td>0.5</td><td>0.7</td><td>0.9</td><td>1.3</td></tr><tr><td>7</td><td>0.9</td><td>1.2</td><td>1.5</td><td>2.1</td></tr><tr><td>9</td><td>1.4</td><td>1.8</td><td>2.2</td><td>3.0</td></tr></table> | 1/2 | 3 | 5 | 7 | 9 | 1 | 0.0 | 0.0 | 0.0 | 0.0 | 3 | 0.2 | 0.3 | 0.4 | 0.6 | 5 | 0.5 | 0.7 | 0.9 | 1.3 | 7 | 0.9 | 1.2 | 1.5 | 2.1 | 9 | 1.4 | 1.8 | 2.2 | 3.0 | | |
| 1/2 | 3 | 5 | 7 | 9 | | | | | | | | | | | | | | | | | | | | | | | | | | | | | |
| 1 | 0.0 | 0.0 | 0.0 | 0.0 | | | | | | | | | | | | | | | | | | | | | | | | | | | | | |
| 3 | 0.2 | 0.3 | 0.4 | 0.6 | | | | | | | | | | | | | | | | | | | | | | | | | | | | | |
| 5 | 0.5 | 0.7 | 0.9 | 1.3 | | | | | | | | | | | | | | | | | | | | | | | | | | | | | |
| 7 | 0.9 | 1.2 | 1.5 | 2.1 | | | | | | | | | | | | | | | | | | | | | | | | | | | | | |
| 9 | 1.4 | 1.8 | 2.2 | 3.0 | | | | | | | | | | | | | | | | | | | | | | | | | | | | | |
| D1. TWISTS BLIND ENTRY | <table border="1"><tr><td>1/2</td><td>3</td><td>5</td><td>7</td><td>9</td></tr><tr><td>2</td><td>0.6</td><td>0.9</td><td>1.3</td><td>1.7</td></tr><tr><td>4</td><td>1.1</td><td>1.5</td><td>2.1</td><td>2.7</td></tr><tr><td>6</td><td>1.7</td><td>2.2</td><td>2.8</td><td>3.4</td></tr><tr><td>8</td><td>2.3</td><td>2.8</td><td>3.4</td><td>4.0</td></tr></table> | 1/2 | 3 | 5 | 7 | 9 | 2 | 0.6 | 0.9 | 1.3 | 1.7 | 4 | 1.1 | 1.5 | 2.1 | 2.7 | 6 | 1.7 | 2.2 | 2.8 | 3.4 | 8 | 2.3 | 2.8 | 3.4 | 4.0 | | | | | | | |
| 1/2 | 3 | 5 | 7 | 9 | | | | | | | | | | | | | | | | | | | | | | | | | | | | | |
| 2 | 0.6 | 0.9 | 1.3 | 1.7 | | | | | | | | | | | | | | | | | | | | | | | | | | | | | |
| 4 | 1.1 | 1.5 | 2.1 | 2.7 | | | | | | | | | | | | | | | | | | | | | | | | | | | | | |
| 6 | 1.7 | 2.2 | 2.8 | 3.4 | | | | | | | | | | | | | | | | | | | | | | | | | | | | | |
| 8 | 2.3 | 2.8 | 3.4 | 4.0 | | | | | | | | | | | | | | | | | | | | | | | | | | | | | |
| E1. BLIND ENTRY | <table border="1"><tr><td>1</td><td>3</td><td>5</td><td>7</td><td>9</td></tr><tr><td>0.1</td><td>0.3</td><td>0.5</td><td>0.7</td><td>0.9</td></tr></table> | 1 | 3 | 5 | 7 | 9 | 0.1 | 0.3 | 0.5 | 0.7 | 0.9 | | | | | | | | | | | | | | | | | | | | | | |
| 1 | 3 | 5 | 7 | 9 | | | | | | | | | | | | | | | | | | | | | | | | | | | | | |
| 0.1 | 0.3 | 0.5 | 0.7 | 0.9 | | | | | | | | | | | | | | | | | | | | | | | | | | | | | |
| BACK (GROUP 5) | | | | | | | | | | | | | | | | | | | | | | | | | | | | | | | | | |
| 62 | | | | | | | | | | | | | | | | | | | | | | | | | | | | | | | | | |
| A1. SOMERSAULTS | <table border="1"><tr><td>1</td><td>3</td><td>5</td><td>7</td><td>9</td></tr><tr><td>2.5</td><td>2.8</td><td>3.4</td><td>4.4</td><td>5.9</td></tr></table> | 1 | 3 | 5 | 7 | 9 | 2.5 | 2.8 | 3.4 | 4.4 | 5.9 | | | | | | | | | | | | | | | | | | | | | | |
| 1 | 3 | 5 | 7 | 9 | | | | | | | | | | | | | | | | | | | | | | | | | | | | | |
| 2.5 | 2.8 | 3.4 | 4.4 | 5.9 | | | | | | | | | | | | | | | | | | | | | | | | | | | | | |
| B1. APPROACH | <table border="1"><tr><td>1</td><td>3</td><td>5</td><td>7</td><td>9</td></tr><tr><td>0.0</td><td>0.1</td><td>0.3</td><td>0.5</td><td>0.7</td></tr></table> | 1 | 3 | 5 | 7 | 9 | 0.0 | 0.1 | 0.3 | 0.5 | 0.7 | | | | | | | | | | | | | | | | | | | | | | |
| 1 | 3 | 5 | 7 | 9 | | | | | | | | | | | | | | | | | | | | | | | | | | | | | |
| 0.0 | 0.1 | 0.3 | 0.5 | 0.7 | | | | | | | | | | | | | | | | | | | | | | | | | | | | | |
| C1. TWISTS | <table border="1"><tr><td>1/2</td><td>3</td><td>5</td><td>7</td><td>9</td></tr><tr><td>2</td><td>0.0</td><td>0.0</td><td>0.0</td><td>0.0</td></tr><tr><td>4</td><td>0.2</td><td>0.3</td><td>0.5</td><td>0.7</td></tr><tr><td>6</td><td>0.5</td><td>0.7</td><td>1.1</td><td>1.5</td></tr><tr><td>8</td><td>0.9</td><td>1.2</td><td>1.8</td><td>2.4</td></tr><tr><td>10</td><td>1.4</td><td>1.8</td><td>2.6</td><td>3.4</td></tr></table> | 1/2 | 3 | 5 | 7 | 9 | 2 | 0.0 | 0.0 | 0.0 | 0.0 | 4 | 0.2 | 0.3 | 0.5 | 0.7 | 6 | 0.5 | 0.7 | 1.1 | 1.5 | 8 | 0.9 | 1.2 | 1.8 | 2.4 | 10 | 1.4 | 1.8 | 2.6 | 3.4 | | |
| 1/2 | 3 | 5 | 7 | 9 | | | | | | | | | | | | | | | | | | | | | | | | | | | | | |
| 2 | 0.0 | 0.0 | 0.0 | 0.0 | | | | | | | | | | | | | | | | | | | | | | | | | | | | | |
| 4 | 0.2 | 0.3 | 0.5 | 0.7 | | | | | | | | | | | | | | | | | | | | | | | | | | | | | |
| 6 | 0.5 | 0.7 | 1.1 | 1.5 | | | | | | | | | | | | | | | | | | | | | | | | | | | | | |
| 8 | 0.9 | 1.2 | 1.8 | 2.4 | | | | | | | | | | | | | | | | | | | | | | | | | | | | | |
| 10 | 1.4 | 1.8 | 2.6 | 3.4 | | | | | | | | | | | | | | | | | | | | | | | | | | | | | |
| D1. TWISTS BLIND ENTRY | <table border="1"><tr><td>1/2</td><td>3</td><td>5</td><td>7</td><td>9</td></tr><tr><td>1</td><td>0.2</td><td>0.3</td><td>0.5</td><td>0.7</td></tr><tr><td>3</td><td>0.6</td><td>1.0</td><td>1.4</td><td>1.8</td></tr><tr><td>5</td><td>1.1</td><td>1.7</td><td>2.3</td><td>2.9</td></tr><tr><td>7</td><td>1.7</td><td>2.5</td><td>3.3</td><td>4.1</td></tr><tr><td>9</td><td>2.4</td><td>3.4</td><td>4.4</td><td>5.4</td></tr></table> | 1/2 | 3 | 5 | 7 | 9 | 1 | 0.2 | 0.3 | 0.5 | 0.7 | 3 | 0.6 | 1.0 | 1.4 | 1.8 | 5 | 1.1 | 1.7 | 2.3 | 2.9 | 7 | 1.7 | 2.5 | 3.3 | 4.1 | 9 | 2.4 | 3.4 | 4.4 | 5.4 | | |
| 1/2 | 3 | 5 | 7 | 9 | | | | | | | | | | | | | | | | | | | | | | | | | | | | | |
| 1 | 0.2 | 0.3 | 0.5 | 0.7 | | | | | | | | | | | | | | | | | | | | | | | | | | | | | |
| 3 | 0.6 | 1.0 | 1.4 | 1.8 | | | | | | | | | | | | | | | | | | | | | | | | | | | | | |
| 5 | 1.1 | 1.7 | 2.3 | 2.9 | | | | | | | | | | | | | | | | | | | | | | | | | | | | | |
| 7 | 1.7 | 2.5 | 3.3 | 4.1 | | | | | | | | | | | | | | | | | | | | | | | | | | | | | |
| 9 | 2.4 | 3.4 | 4.4 | 5.4 | | | | | | | | | | | | | | | | | | | | | | | | | | | | | |
| F1. BACK ROTATION CONTROL ENTRY | <table border="1"><tr><td>1</td><td>3</td><td>5</td><td>7</td><td>9</td></tr><tr><td>0.1</td><td>0.2</td><td>0.3</td><td>0.4</td><td>0.6</td></tr></table> | 1 | 3 | 5 | 7 | 9 | 0.1 | 0.2 | 0.3 | 0.4 | 0.6 | | | | | | | | | | | | | | | | | | | | | | |
| 1 | 3 | 5 | 7 | 9 | | | | | | | | | | | | | | | | | | | | | | | | | | | | | |
| 0.1 | 0.2 | 0.3 | 0.4 | 0.6 | | | | | | | | | | | | | | | | | | | | | | | | | | | | | |

POSITIONS VALUES FOR ALL GROUPS

| | | | | | |
|---------------|------|------|------|------|------|
| STAND. 1/2 SS | 2 | 4 | 6 | 8 | 10 |
| ARM. 1/2 SS | 1 | 3 | 5 | 7 | 9 |
| A | 0.0 | 0.0 | 0.0 | 0.0 | 0.0 |
| B | 0.0 | 0.0 | 0.0 | 0.0 | 0.0 |
| Flying B | -0.1 | -0.1 | -0.2 | -0.4 | - |
| Mid-turn B | - | - | - | 0.1 | 0.3 |
| C | -0.1 | -0.2 | -0.2 | -0.3 | -0.5 |
| Flying C | 0.0 | -0.1 | -0.1 | -0.2 | - |
| Mid-turn C | - | - | - | 0.0 | 0.0 |
| D | -0.0 | -0.0 | -0.0 | -0.0 | -0.0 |
| E | -0.1 | -0.1 | -0.1 | -0.2 | -0.4 |

HIGH DIVING: 27 METRES

| STANDING DIVES A+B+C+D+E+F=DD | | ARMSTAND DIVES A1+B1+C1+D1+E1+F1=DD | | | | | | | | | | | | | | | | | | | | | | | | | | | | | | | | | | | | | | | | | | | | | | | | | | | | | | | | | | | | | | | | | | | | | | | | | | | | | | | | | | | | | | | | | | | | | | | | | | | | | | | | | | | | | | | | | | | | | | | | | | | | | | | | | | | | | | | | | | | | | | | | | | | | | | | | | | | | | | | | | | | | | | | | | | | | | | | | | | | | | | | | | | | | | | | | | | | | | | | | | | | | | | | | | | | | | | | | | | | | | | | | | | | | | | | | | | | | | | | | | | | | | | | | | | | | | | | | | | | | | | | | | | | | | | | | | | | | | | | | | | | | | | | | | | | | | | | | | | | | | | | | | | | | | | | | | | | | | | | | | | | | | | | | | | | | | | | | | | | | | | | | | | | | | | | | | | | | | | | | | | | | | | | | | | | | | | | | | | | | | | | | | | | | | | | | | | | | | | | | | | | | | | | | | | | | | | | | | | | | | | | | | | | | | | | | | | | | | | | | | | | | | | | | | | | | | | | | | | | | | | | | | | | | | | | | | | | | | | | | | | | | | | | | | | | | | | | | | | | | | | | | | | | | | | | | | | | | | | | | | | | | | | | | | | | | | | | | | | | | | | | | | | | | | | | | | | | | | | | | | | | | | | | | | | | | | | | | |
|---|------|--|------|------|------|------|-----|-----|-------------|-----|-----|---|---|---|----|----|-----|-----|-----|-----|-----|-----|---|-----|-----|-----|-----|-----|-----|------|-----|-----|-----|-----|-----|-----|-----|-----|-----|-----|-----|-----|-----|--------|------|------|------|------|------|------|--------|-----|------|------|------|------|---|-------|-----|-----|-----|---|-----|-----|-----|-----|-----|-----|-----|-----|-----|---|-----|-----|-----|-----|-----|-----|---|---|----|-----|-----|-----|-----|-----|--|--|---|---|---|---|----|-----|-----|-----|-----|-----|---|---|---|---|----|-----|-----|-----|-----|-----|---|---|---|---|----|---|---|---|---|---|---|-----|-----|-----|-----|---|-----|-----|-----|-----|---|-----|-----|-----|-----|---|-----|-----|-----|-----|---|---|---|---|----|---|-----|-----|-----|-----|---|-----|-----|-----|-----|---|-----|-----|-----|-----|---|-----|-----|-----|-----|---|---|---|---|----|-----|-----|-----|-----|-----|---|--|---|---|---|---|---|-----|-----|-----|-----|-----|---|---|---|---|---|-----|-----|-----|-----|-----|---|---|---|---|---|---|---|---|---|---|---|-----|-----|-----|-----|---|-----|-----|-----|-----|---|-----|-----|-----|-----|---|-----|-----|-----|-----|---|---|---|---|---|---|-----|-----|-----|-----|---|-----|-----|-----|-----|---|-----|-----|-----|-----|---|-----|-----|-----|-----|---|---|---|---|---|-----|-----|-----|-----|-----|--|--|---|---|---|---|----|-----|-----|-----|-----|-----|---|---|---|---|----|-----|-----|-----|-----|-----|---|---|---|---|----|---|---|---|---|---|---|-----|-----|-----|-----|---|-----|-----|-----|-----|---|-----|-----|-----|-----|---|-----|-----|-----|-----|---|---|---|---|----|---|-----|-----|-----|-----|---|-----|-----|-----|-----|---|-----|-----|-----|-----|---|-----|-----|-----|-----|---|-----|-----|-----|-----|---|---|---|---|----|-----|-----|-----|-----|-----|--|--|---|---|---|---|----|-----|-----|-----|-----|-----|---|---|---|---|----|-----|-----|-----|-----|-----|---|---|---|---|----|---|---|---|---|---|---|-----|-----|-----|-----|---|-----|-----|-----|-----|---|-----|-----|-----|-----|---|-----|-----|-----|-----|----|-----|-----|-----|-----|---|---|---|---|----|---|-----|-----|-----|-----|---|-----|-----|-----|-----|---|-----|-----|-----|-----|---|-----|-----|-----|-----|---|-----|-----|-----|-----|---|---|---|---|----|-----|-----|-----|-----|-----|---|--|---|---|---|---|---|-----|-----|-----|-----|-----|---|---|---|---|---|-----|-----|-----|-----|-----|---|---|---|---|---|---|---|---|---|---|---|-----|-----|-----|-----|---|-----|-----|-----|-----|---|-----|-----|-----|-----|---|-----|-----|-----|-----|----|-----|-----|-----|-----|---|---|---|---|---|---|-----|-----|-----|-----|---|-----|-----|-----|-----|---|-----|-----|-----|-----|---|-----|-----|-----|-----|---|-----|-----|-----|-----|---|---|---|---|---|-----|-----|-----|-----|-----|--|--|---|---|---|---|---|-----|-----|-----|-----|-----|---|---|---|---|---|-----|-----|-----|-----|-----|---|---|---|---|---|-----|-----|-----|-----|-----|
| <p>FORWARD (GROUP 1)</p> <p>1 - 51</p> <p>A. SOMERSAULTS</p> <table border="1"> <tr><td>2</td><td>4</td><td>6</td><td>8</td><td>10</td></tr> <tr><td>2.6</td><td>2.9</td><td>3.4</td><td>4.1</td><td>5.1</td></tr> </table> <p>B. APPROACH</p> <table border="1"> <tr><td>2</td><td>4</td><td>6</td><td>8</td><td>10</td></tr> <tr><td>0.0</td><td>0.0</td><td>0.0</td><td>0.0</td><td>0.0</td></tr> </table> <p>C. TWISTS BARANI ENTRY</p> <table border="1"> <tr><td>2</td><td>4</td><td>6</td><td>8</td><td>10</td></tr> <tr><td>1</td><td>0</td><td>0</td><td>0</td><td>0</td></tr> <tr><td>3</td><td>0.2</td><td>0.3</td><td>0.4</td><td>0.6</td></tr> <tr><td>5</td><td>0.5</td><td>0.7</td><td>0.9</td><td>1.3</td></tr> <tr><td>7</td><td>0.9</td><td>1.2</td><td>1.5</td><td>2.1</td></tr> <tr><td>9</td><td>1.4</td><td>1.8</td><td>2.2</td><td>3.0</td></tr> </table> <p>D. TWISTS BLIND ENTRY</p> <table border="1"> <tr><td>2</td><td>4</td><td>6</td><td>8</td><td>10</td></tr> <tr><td>1</td><td>0.4</td><td>0.6</td><td>0.8</td><td>1.2</td></tr> <tr><td>4</td><td>1.1</td><td>1.4</td><td>2.0</td><td>1.6</td></tr> <tr><td>6</td><td>1.7</td><td>2.1</td><td>2.9</td><td>...</td></tr> <tr><td>8</td><td>...</td><td>...</td><td>...</td><td>...</td></tr> </table> <p>E. BLIND ENTRY</p> <table border="1"> <tr><td>2</td><td>4</td><td>6</td><td>8</td><td>10</td></tr> <tr><td>0.2</td><td>0.3</td><td>0.4</td><td>0.6</td><td>0.8</td></tr> </table> | | 2 | 4 | 6 | 8 | 10 | 2.6 | 2.9 | 3.4 | 4.1 | 5.1 | 2 | 4 | 6 | 8 | 10 | 0.0 | 0.0 | 0.0 | 0.0 | 0.0 | 2 | 4 | 6 | 8 | 10 | 1 | 0 | 0 | 0 | 0 | 3 | 0.2 | 0.3 | 0.4 | 0.6 | 5 | 0.5 | 0.7 | 0.9 | 1.3 | 7 | 0.9 | 1.2 | 1.5 | 2.1 | 9 | 1.4 | 1.8 | 2.2 | 3.0 | 2 | 4 | 6 | 8 | 10 | 1 | 0.4 | 0.6 | 0.8 | 1.2 | 4 | 1.1 | 1.4 | 2.0 | 1.6 | 6 | 1.7 | 2.1 | 2.9 | ... | 8 | ... | ... | ... | ... | 2 | 4 | 6 | 8 | 10 | 0.2 | 0.3 | 0.4 | 0.6 | 0.8 | <p>INWARD (GROUP 4)</p> <p>4 - 54</p> <p>A. SOMERSAULTS</p> <table border="1"> <tr><td>2</td><td>4</td><td>6</td><td>8</td><td>10</td></tr> <tr><td>2.6</td><td>2.9</td><td>3.4</td><td>4.1</td><td>5.1</td></tr> </table> <p>B. APPROACH</p> <table border="1"> <tr><td>2</td><td>4</td><td>6</td><td>8</td><td>10</td></tr> <tr><td>0.0</td><td>0.2</td><td>0.4</td><td>0.6</td><td>0.8</td></tr> </table> <p>C. TWISTS BARANI ENTRY</p> <table border="1"> <tr><td>2</td><td>4</td><td>6</td><td>8</td><td>10</td></tr> <tr><td>1</td><td>0</td><td>0</td><td>0</td><td>0</td></tr> <tr><td>3</td><td>0.3</td><td>0.4</td><td>0.5</td><td>0.7</td></tr> <tr><td>5</td><td>0.7</td><td>0.9</td><td>1.1</td><td>1.5</td></tr> <tr><td>7</td><td>1.2</td><td>1.5</td><td>1.8</td><td>2.4</td></tr> <tr><td>9</td><td>1.8</td><td>2.2</td><td>2.6</td><td>3.4</td></tr> </table> <p>D. TWISTS BLIND ENTRY</p> <table border="1"> <tr><td>2</td><td>4</td><td>6</td><td>8</td><td>10</td></tr> <tr><td>1</td><td>0.6</td><td>0.8</td><td>1.0</td><td>1.4</td></tr> <tr><td>4</td><td>1.4</td><td>1.7</td><td>2.3</td><td>...</td></tr> <tr><td>6</td><td>...</td><td>...</td><td>...</td><td>...</td></tr> <tr><td>8</td><td>...</td><td>...</td><td>...</td><td>...</td></tr> </table> <p>E. BLIND ENTRY</p> <table border="1"> <tr><td>2</td><td>4</td><td>6</td><td>8</td><td>10</td></tr> <tr><td>0.3</td><td>0.4</td><td>0.5</td><td>0.7</td><td>0.9</td></tr> </table> | | 2 | 4 | 6 | 8 | 10 | 2.6 | 2.9 | 3.4 | 4.1 | 5.1 | 2 | 4 | 6 | 8 | 10 | 0.0 | 0.2 | 0.4 | 0.6 | 0.8 | 2 | 4 | 6 | 8 | 10 | 1 | 0 | 0 | 0 | 0 | 3 | 0.3 | 0.4 | 0.5 | 0.7 | 5 | 0.7 | 0.9 | 1.1 | 1.5 | 7 | 1.2 | 1.5 | 1.8 | 2.4 | 9 | 1.8 | 2.2 | 2.6 | 3.4 | 2 | 4 | 6 | 8 | 10 | 1 | 0.6 | 0.8 | 1.0 | 1.4 | 4 | 1.4 | 1.7 | 2.3 | ... | 6 | ... | ... | ... | ... | 8 | ... | ... | ... | ... | 2 | 4 | 6 | 8 | 10 | 0.3 | 0.4 | 0.5 | 0.7 | 0.9 | <p>FORWARD (GROUP 5)</p> <p>61</p> <p>A1. SOMERSAULTS</p> <table border="1"> <tr><td>1</td><td>3</td><td>5</td><td>7</td><td>9</td></tr> <tr><td>2.6</td><td>2.9</td><td>3.4</td><td>4.1</td><td>5.1</td></tr> </table> <p>B1. APPROACH</p> <table border="1"> <tr><td>1</td><td>3</td><td>5</td><td>7</td><td>9</td></tr> <tr><td>0.0</td><td>0.1</td><td>0.3</td><td>0.5</td><td>0.7</td></tr> </table> <p>C1. TWISTS BARANI ENTRY</p> <table border="1"> <tr><td>1</td><td>3</td><td>5</td><td>7</td><td>9</td></tr> <tr><td>1</td><td>0</td><td>0</td><td>0</td><td>0</td></tr> <tr><td>3</td><td>0.2</td><td>0.3</td><td>0.4</td><td>0.6</td></tr> <tr><td>5</td><td>0.5</td><td>0.7</td><td>0.9</td><td>1.3</td></tr> <tr><td>7</td><td>0.9</td><td>1.2</td><td>1.5</td><td>2.1</td></tr> <tr><td>9</td><td>1.4</td><td>1.8</td><td>2.2</td><td>3.0</td></tr> </table> <p>D1. TWISTS BLIND ENTRY</p> <table border="1"> <tr><td>1</td><td>3</td><td>5</td><td>7</td><td>9</td></tr> <tr><td>1</td><td>0.5</td><td>0.9</td><td>1.3</td><td>...</td></tr> <tr><td>4</td><td>...</td><td>...</td><td>...</td><td>...</td></tr> <tr><td>6</td><td>...</td><td>...</td><td>...</td><td>...</td></tr> <tr><td>8</td><td>...</td><td>...</td><td>...</td><td>...</td></tr> </table> <p>E1. BLIND ENTRY</p> <table border="1"> <tr><td>1</td><td>3</td><td>5</td><td>7</td><td>9</td></tr> <tr><td>0.1</td><td>0.3</td><td>0.5</td><td>0.7</td><td>0.9</td></tr> </table> | | 1 | 3 | 5 | 7 | 9 | 2.6 | 2.9 | 3.4 | 4.1 | 5.1 | 1 | 3 | 5 | 7 | 9 | 0.0 | 0.1 | 0.3 | 0.5 | 0.7 | 1 | 3 | 5 | 7 | 9 | 1 | 0 | 0 | 0 | 0 | 3 | 0.2 | 0.3 | 0.4 | 0.6 | 5 | 0.5 | 0.7 | 0.9 | 1.3 | 7 | 0.9 | 1.2 | 1.5 | 2.1 | 9 | 1.4 | 1.8 | 2.2 | 3.0 | 1 | 3 | 5 | 7 | 9 | 1 | 0.5 | 0.9 | 1.3 | ... | 4 | ... | ... | ... | ... | 6 | ... | ... | ... | ... | 8 | ... | ... | ... | ... | 1 | 3 | 5 | 7 | 9 | 0.1 | 0.3 | 0.5 | 0.7 | 0.9 | <p>BACK (GROUP 2)</p> <p>2 - 52</p> <p>A. SOMERSAULTS</p> <table border="1"> <tr><td>2</td><td>4</td><td>6</td><td>8</td><td>10</td></tr> <tr><td>2.6</td><td>2.9</td><td>3.4</td><td>4.1</td><td>5.1</td></tr> </table> <p>B. APPROACH</p> <table border="1"> <tr><td>2</td><td>4</td><td>6</td><td>8</td><td>10</td></tr> <tr><td>0.1</td><td>0.2</td><td>0.3</td><td>0.4</td><td>0.5</td></tr> </table> <p>C. TWISTS BARANI ENTRY</p> <table border="1"> <tr><td>2</td><td>4</td><td>6</td><td>8</td><td>10</td></tr> <tr><td>1</td><td>0</td><td>0</td><td>0</td><td>0</td></tr> <tr><td>3</td><td>0.2</td><td>0.3</td><td>0.4</td><td>0.6</td></tr> <tr><td>5</td><td>0.5</td><td>0.7</td><td>0.9</td><td>1.3</td></tr> <tr><td>7</td><td>0.9</td><td>1.2</td><td>1.5</td><td>2.1</td></tr> <tr><td>9</td><td>1.5</td><td>1.9</td><td>2.3</td><td>3.1</td></tr> </table> <p>D. TWISTS BLIND ENTRY</p> <table border="1"> <tr><td>2</td><td>4</td><td>6</td><td>8</td><td>10</td></tr> <tr><td>1</td><td>0.2</td><td>0.3</td><td>0.5</td><td>0.9</td></tr> <tr><td>3</td><td>0.6</td><td>0.8</td><td>1.2</td><td>...</td></tr> <tr><td>5</td><td>...</td><td>...</td><td>...</td><td>...</td></tr> <tr><td>7</td><td>...</td><td>...</td><td>...</td><td>...</td></tr> <tr><td>9</td><td>...</td><td>...</td><td>...</td><td>...</td></tr> </table> <p>F. BACK ROTATION CONTROL ENTRY</p> <table border="1"> <tr><td>2</td><td>4</td><td>6</td><td>8</td><td>10</td></tr> <tr><td>0.0</td><td>0.0</td><td>0.1</td><td>0.1</td><td>0.2</td></tr> </table> | | 2 | 4 | 6 | 8 | 10 | 2.6 | 2.9 | 3.4 | 4.1 | 5.1 | 2 | 4 | 6 | 8 | 10 | 0.1 | 0.2 | 0.3 | 0.4 | 0.5 | 2 | 4 | 6 | 8 | 10 | 1 | 0 | 0 | 0 | 0 | 3 | 0.2 | 0.3 | 0.4 | 0.6 | 5 | 0.5 | 0.7 | 0.9 | 1.3 | 7 | 0.9 | 1.2 | 1.5 | 2.1 | 9 | 1.5 | 1.9 | 2.3 | 3.1 | 2 | 4 | 6 | 8 | 10 | 1 | 0.2 | 0.3 | 0.5 | 0.9 | 3 | 0.6 | 0.8 | 1.2 | ... | 5 | ... | ... | ... | ... | 7 | ... | ... | ... | ... | 9 | ... | ... | ... | ... | 2 | 4 | 6 | 8 | 10 | 0.0 | 0.0 | 0.1 | 0.1 | 0.2 | <p>REVERSE (GROUP 3)</p> <p>3 - 53</p> <p>A. SOMERSAULTS</p> <table border="1"> <tr><td>2</td><td>4</td><td>6</td><td>8</td><td>10</td></tr> <tr><td>2.6</td><td>2.9</td><td>3.4</td><td>4.1</td><td>5.1</td></tr> </table> <p>B. APPROACH</p> <table border="1"> <tr><td>2</td><td>4</td><td>6</td><td>8</td><td>10</td></tr> <tr><td>0.1</td><td>0.2</td><td>0.4</td><td>0.6</td><td>0.8</td></tr> </table> <p>C. TWISTS BARANI ENTRY</p> <table border="1"> <tr><td>2</td><td>4</td><td>6</td><td>8</td><td>10</td></tr> <tr><td>1</td><td>0</td><td>0</td><td>0</td><td>0</td></tr> <tr><td>3</td><td>0.3</td><td>0.4</td><td>0.5</td><td>0.7</td></tr> <tr><td>5</td><td>0.7</td><td>0.9</td><td>1.1</td><td>1.5</td></tr> <tr><td>7</td><td>1.2</td><td>1.5</td><td>1.8</td><td>2.4</td></tr> <tr><td>9</td><td>1.9</td><td>2.3</td><td>2.7</td><td>3.3</td></tr> <tr><td>10</td><td>2.5</td><td>3.1</td><td>3.9</td><td>4.7</td></tr> </table> <p>D. TWISTS BLIND ENTRY</p> <table border="1"> <tr><td>2</td><td>4</td><td>6</td><td>8</td><td>10</td></tr> <tr><td>1</td><td>0.2</td><td>0.3</td><td>0.5</td><td>0.7</td></tr> <tr><td>3</td><td>0.7</td><td>0.9</td><td>1.1</td><td>1.5</td></tr> <tr><td>5</td><td>1.3</td><td>1.5</td><td>1.8</td><td>2.5</td></tr> <tr><td>7</td><td>2.0</td><td>2.3</td><td>2.7</td><td>3.6</td></tr> <tr><td>9</td><td>2.9</td><td>3.5</td><td>4.3</td><td>5.6</td></tr> </table> <p>F. BACK ROTATION CONTROL ENTRY</p> <table border="1"> <tr><td>2</td><td>4</td><td>6</td><td>8</td><td>10</td></tr> <tr><td>0.0</td><td>0.0</td><td>0.1</td><td>0.1</td><td>0.2</td></tr> </table> | | 2 | 4 | 6 | 8 | 10 | 2.6 | 2.9 | 3.4 | 4.1 | 5.1 | 2 | 4 | 6 | 8 | 10 | 0.1 | 0.2 | 0.4 | 0.6 | 0.8 | 2 | 4 | 6 | 8 | 10 | 1 | 0 | 0 | 0 | 0 | 3 | 0.3 | 0.4 | 0.5 | 0.7 | 5 | 0.7 | 0.9 | 1.1 | 1.5 | 7 | 1.2 | 1.5 | 1.8 | 2.4 | 9 | 1.9 | 2.3 | 2.7 | 3.3 | 10 | 2.5 | 3.1 | 3.9 | 4.7 | 2 | 4 | 6 | 8 | 10 | 1 | 0.2 | 0.3 | 0.5 | 0.7 | 3 | 0.7 | 0.9 | 1.1 | 1.5 | 5 | 1.3 | 1.5 | 1.8 | 2.5 | 7 | 2.0 | 2.3 | 2.7 | 3.6 | 9 | 2.9 | 3.5 | 4.3 | 5.6 | 2 | 4 | 6 | 8 | 10 | 0.0 | 0.0 | 0.1 | 0.1 | 0.2 | <p>BACK (GROUP 5)</p> <p>62</p> <p>A1. SOMERSAULTS</p> <table border="1"> <tr><td>1</td><td>3</td><td>5</td><td>7</td><td>9</td></tr> <tr><td>2.6</td><td>2.9</td><td>3.4</td><td>4.1</td><td>5.1</td></tr> </table> <p>B1. APPROACH</p> <table border="1"> <tr><td>1</td><td>3</td><td>5</td><td>7</td><td>9</td></tr> <tr><td>0.0</td><td>0.1</td><td>0.2</td><td>0.4</td><td>0.6</td></tr> </table> <p>C1. TWISTS BARANI ENTRY</p> <table border="1"> <tr><td>1</td><td>3</td><td>5</td><td>7</td><td>9</td></tr> <tr><td>1</td><td>0</td><td>0</td><td>0</td><td>0</td></tr> <tr><td>3</td><td>0.3</td><td>0.4</td><td>0.5</td><td>0.7</td></tr> <tr><td>5</td><td>0.7</td><td>0.9</td><td>1.1</td><td>1.5</td></tr> <tr><td>7</td><td>1.2</td><td>1.5</td><td>1.8</td><td>2.4</td></tr> <tr><td>9</td><td>1.8</td><td>2.2</td><td>2.6</td><td>3.4</td></tr> <tr><td>10</td><td>2.2</td><td>2.6</td><td>3.4</td><td>4.2</td></tr> </table> <p>D1. TWISTS BLIND ENTRY</p> <table border="1"> <tr><td>1</td><td>3</td><td>5</td><td>7</td><td>9</td></tr> <tr><td>1</td><td>0.2</td><td>0.3</td><td>0.5</td><td>0.7</td></tr> <tr><td>3</td><td>0.7</td><td>0.9</td><td>1.1</td><td>1.5</td></tr> <tr><td>5</td><td>1.3</td><td>1.5</td><td>1.8</td><td>2.3</td></tr> <tr><td>7</td><td>2.0</td><td>2.3</td><td>2.7</td><td>3.3</td></tr> <tr><td>9</td><td>2.8</td><td>3.4</td><td>4.2</td><td>5.3</td></tr> </table> <p>F1. BACK ROTATION CONTROL ENTRY</p> <table border="1"> <tr><td>1</td><td>3</td><td>5</td><td>7</td><td>9</td></tr> <tr><td>0.0</td><td>0.1</td><td>0.2</td><td>0.3</td><td>0.4</td></tr> </table> | | 1 | 3 | 5 | 7 | 9 | 2.6 | 2.9 | 3.4 | 4.1 | 5.1 | 1 | 3 | 5 | 7 | 9 | 0.0 | 0.1 | 0.2 | 0.4 | 0.6 | 1 | 3 | 5 | 7 | 9 | 1 | 0 | 0 | 0 | 0 | 3 | 0.3 | 0.4 | 0.5 | 0.7 | 5 | 0.7 | 0.9 | 1.1 | 1.5 | 7 | 1.2 | 1.5 | 1.8 | 2.4 | 9 | 1.8 | 2.2 | 2.6 | 3.4 | 10 | 2.2 | 2.6 | 3.4 | 4.2 | 1 | 3 | 5 | 7 | 9 | 1 | 0.2 | 0.3 | 0.5 | 0.7 | 3 | 0.7 | 0.9 | 1.1 | 1.5 | 5 | 1.3 | 1.5 | 1.8 | 2.3 | 7 | 2.0 | 2.3 | 2.7 | 3.3 | 9 | 2.8 | 3.4 | 4.2 | 5.3 | 1 | 3 | 5 | 7 | 9 | 0.0 | 0.1 | 0.2 | 0.3 | 0.4 | <p>REVERSE (GROUP 5)</p> <p>63</p> <p>A1. SOMERSAULTS</p> <table border="1"> <tr><td>1</td><td>3</td><td>5</td><td>7</td><td>9</td></tr> <tr><td>2.6</td><td>2.9</td><td>3.4</td><td>4.1</td><td>5.1</td></tr> </table> <p>B1. APPROACH</p> <table border="1"> <tr><td>1</td><td>3</td><td>5</td><td>7</td><td>9</td></tr> <tr><td>0.1</td><td>0.3</td><td>0.5</td><td>0.7</td><td>0.9</td></tr> </table> <p>F1. BACK ROTATION CONTROL ENTRY</p> <table border="1"> <tr><td>1</td><td>3</td><td>5</td><td>7</td><td>9</td></tr> <tr><td>0.0</td><td>0.1</td><td>0.2</td><td>0.3</td><td>0.4</td></tr> </table> | | 1 | 3 | 5 | 7 | 9 | 2.6 | 2.9 | 3.4 | 4.1 | 5.1 | 1 | 3 | 5 | 7 | 9 | 0.1 | 0.3 | 0.5 | 0.7 | 0.9 | 1 | 3 | 5 | 7 | 9 | 0.0 | 0.1 | 0.2 | 0.3 | 0.4 |
| 2 | 4 | 6 | 8 | 10 | | | | | | | | | | | | | | | | | | | | | | | | | | | | | | | | | | | | | | | | | | | | | | | | | | | | | | | | | | | | | | | | | | | | | | | | | | | | | | | | | | | | | | | | | | | | | | | | | | | | | | | | | | | | | | | | | | | | | | | | | | | | | | | | | | | | | | | | | | | | | | | | | | | | | | | | | | | | | | | | | | | | | | | | | | | | | | | | | | | | | | | | | | | | | | | | | | | | | | | | | | | | | | | | | | | | | | | | | | | | | | | | | | | | | | | | | | | | | | | | | | | | | | | | | | | | | | | | | | | | | | | | | | | | | | | | | | | | | | | | | | | | | | | | | | | | | | | | | | | | | | | | | | | | | | | | | | | | | | | | | | | | | | | | | | | | | | | | | | | | | | | | | | | | | | | | | | | | | | | | | | | | | | | | | | | | | | | | | | | | | | | | | | | | | | | | | | | | | | | | | | | | | | | | | | | | | | | | | | | | | | | | | | | | | | | | | | | | | | | | | | | | | | | | | | | | | | | | | | | | | | | | | | | | | | | | | | | | | | | | | | | | | | | | | | | | | | | | | | | | | | | | | | | | | | | | | | | | | | | | | | | | | | | | | | | | | | | | | | | | | | | | | | | | | | | | | | | | | | | | | | | | | | | | | | | | | | |
| 2.6 | 2.9 | 3.4 | 4.1 | 5.1 | | | | | | | | | | | | | | | | | | | | | | | | | | | | | | | | | | | | | | | | | | | | | | | | | | | | | | | | | | | | | | | | | | | | | | | | | | | | | | | | | | | | | | | | | | | | | | | | | | | | | | | | | | | | | | | | | | | | | | | | | | | | | | | | | | | | | | | | | | | | | | | | | | | | | | | | | | | | | | | | | | | | | | | | | | | | | | | | | | | | | | | | | | | | | | | | | | | | | | | | | | | | | | | | | | | | | | | | | | | | | | | | | | | | | | | | | | | | | | | | | | | | | | | | | | | | | | | | | | | | | | | | | | | | | | | | | | | | | | | | | | | | | | | | | | | | | | | | | | | | | | | | | | | | | | | | | | | | | | | | | | | | | | | | | | | | | | | | | | | | | | | | | | | | | | | | | | | | | | | | | | | | | | | | | | | | | | | | | | | | | | | | | | | | | | | | | | | | | | | | | | | | | | | | | | | | | | | | | | | | | | | | | | | | | | | | | | | | | | | | | | | | | | | | | | | | | | | | | | | | | | | | | | | | | | | | | | | | | | | | | | | | | | | | | | | | | | | | | | | | | | | | | | | | | | | | | | | | | | | | | | | | | | | | | | | | | | | | | | | | | | | | | | | | | | | | | | | | | | | | | | | | | | | | | | | | | | |
| 2 | 4 | 6 | 8 | 10 | | | | | | | | | | | | | | | | | | | | | | | | | | | | | | | | | | | | | | | | | | | | | | | | | | | | | | | | | | | | | | | | | | | | | | | | | | | | | | | | | | | | | | | | | | | | | | | | | | | | | | | | | | | | | | | | | | | | | | | | | | | | | | | | | | | | | | | | | | | | | | | | | | | | | | | | | | | | | | | | | | | | | | | | | | | | | | | | | | | | | | | | | | | | | | | | | | | | | | | | | | | | | | | | | | | | | | | | | | | | | | | | | | | | | | | | | | | | | | | | | | | | | | | | | | | | | | | | | | | | | | | | | | | | | | | | | | | | | | | | | | | | | | | | | | | | | | | | | | | | | | | | | | | | | | | | | | | | | | | | | | | | | | | | | | | | | | | | | | | | | | | | | | | | | | | | | | | | | | | | | | | | | | | | | | | | | | | | | | | | | | | | | | | | | | | | | | | | | | | | | | | | | | | | | | | | | | | | | | | | | | | | | | | | | | | | | | | | | | | | | | | | | | | | | | | | | | | | | | | | | | | | | | | | | | | | | | | | | | | | | | | | | | | | | | | | | | | | | | | | | | | | | | | | | | | | | | | | | | | | | | | | | | | | | | | | | | | | | | | | | | | | | | | | | | | | | | | | | | | | | | | | | | | | | | | | | | |
| 0.0 | 0.0 | 0.0 | 0.0 | 0.0 | | | | | | | | | | | | | | | | | | | | | | | | | | | | | | | | | | | | | | | | | | | | | | | | | | | | | | | | | | | | | | | | | | | | | | | | | | | | | | | | | | | | | | | | | | | | | | | | | | | | | | | | | | | | | | | | | | | | | | | | | | | | | | | | | | | | | | | | | | | | | | | | | | | | | | | | | | | | | | | | | | | | | | | | | | | | | | | | | | | | | | | | | | | | | | | | | | | | | | | | | | | | | | | | | | | | | | | | | | | | | | | | | | | | | | | | | | | | | | | | | | | | | | | | | | | | | | | | | | | | | | | | | | | | | | | | | | | | | | | | | | | | | | | | | | | | | | | | | | | | | | | | | | | | | | | | | | | | | | | | | | | | | | | | | | | | | | | | | | | | | | | | | | | | | | | | | | | | | | | | | | | | | | | | | | | | | | | | | | | | | | | | | | | | | | | | | | | | | | | | | | | | | | | | | | | | | | | | | | | | | | | | | | | | | | | | | | | | | | | | | | | | | | | | | | | | | | | | | | | | | | | | | | | | | | | | | | | | | | | | | | | | | | | | | | | | | | | | | | | | | | | | | | | | | | | | | | | | | | | | | | | | | | | | | | | | | | | | | | | | | | | | | | | | | | | | | | | | | | | | | | | | | | | | | | | | | | |
| 2 | 4 | 6 | 8 | 10 | | | | | | | | | | | | | | | | | | | | | | | | | | | | | | | | | | | | | | | | | | | | | | | | | | | | | | | | | | | | | | | | | | | | | | | | | | | | | | | | | | | | | | | | | | | | | | | | | | | | | | | | | | | | | | | | | | | | | | | | | | | | | | | | | | | | | | | | | | | | | | | | | | | | | | | | | | | | | | | | | | | | | | | | | | | | | | | | | | | | | | | | | | | | | | | | | | | | | | | | | | | | | | | | | | | | | | | | | | | | | | | | | | | | | | | | | | | | | | | | | | | | | | | | | | | | | | | | | | | | | | | | | | | | | | | | | | | | | | | | | | | | | | | | | | | | | | | | | | | | | | | | | | | | | | | | | | | | | | | | | | | | | | | | | | | | | | | | | | | | | | | | | | | | | | | | | | | | | | | | | | | | | | | | | | | | | | | | | | | | | | | | | | | | | | | | | | | | | | | | | | | | | | | | | | | | | | | | | | | | | | | | | | | | | | | | | | | | | | | | | | | | | | | | | | | | | | | | | | | | | | | | | | | | | | | | | | | | | | | | | | | | | | | | | | | | | | | | | | | | | | | | | | | | | | | | | | | | | | | | | | | | | | | | | | | | | | | | | | | | | | | | | | | | | | | | | | | | | | | | | | | | | | | | | | | | | | |
| 1 | 0 | 0 | 0 | 0 | | | | | | | | | | | | | | | | | | | | | | | | | | | | | | | | | | | | | | | | | | | | | | | | | | | | | | | | | | | | | | | | | | | | | | | | | | | | | | | | | | | | | | | | | | | | | | | | | | | | | | | | | | | | | | | | | | | | | | | | | | | | | | | | | | | | | | | | | | | | | | | | | | | | | | | | | | | | | | | | | | | | | | | | | | | | | | | | | | | | | | | | | | | | | | | | | | | | | | | | | | | | | | | | | | | | | | | | | | | | | | | | | | | | | | | | | | | | | | | | | | | | | | | | | | | | | | | | | | | | | | | | | | | | | | | | | | | | | | | | | | | | | | | | | | | | | | | | | | | | | | | | | | | | | | | | | | | | | | | | | | | | | | | | | | | | | | | | | | | | | | | | | | | | | | | | | | | | | | | | | | | | | | | | | | | | | | | | | | | | | | | | | | | | | | | | | | | | | | | | | | | | | | | | | | | | | | | | | | | | | | | | | | | | | | | | | | | | | | | | | | | | | | | | | | | | | | | | | | | | | | | | | | | | | | | | | | | | | | | | | | | | | | | | | | | | | | | | | | | | | | | | | | | | | | | | | | | | | | | | | | | | | | | | | | | | | | | | | | | | | | | | | | | | | | | | | | | | | | | | | | | | | | | | | | | | | | |
| 3 | 0.2 | 0.3 | 0.4 | 0.6 | | | | | | | | | | | | | | | | | | | | | | | | | | | | | | | | | | | | | | | | | | | | | | | | | | | | | | | | | | | | | | | | | | | | | | | | | | | | | | | | | | | | | | | | | | | | | | | | | | | | | | | | | | | | | | | | | | | | | | | | | | | | | | | | | | | | | | | | | | | | | | | | | | | | | | | | | | | | | | | | | | | | | | | | | | | | | | | | | | | | | | | | | | | | | | | | | | | | | | | | | | | | | | | | | | | | | | | | | | | | | | | | | | | | | | | | | | | | | | | | | | | | | | | | | | | | | | | | | | | | | | | | | | | | | | | | | | | | | | | | | | | | | | | | | | | | | | | | | | | | | | | | | | | | | | | | | | | | | | | | | | | | | | | | | | | | | | | | | | | | | | | | | | | | | | | | | | | | | | | | | | | | | | | | | | | | | | | | | | | | | | | | | | | | | | | | | | | | | | | | | | | | | | | | | | | | | | | | | | | | | | | | | | | | | | | | | | | | | | | | | | | | | | | | | | | | | | | | | | | | | | | | | | | | | | | | | | | | | | | | | | | | | | | | | | | | | | | | | | | | | | | | | | | | | | | | | | | | | | | | | | | | | | | | | | | | | | | | | | | | | | | | | | | | | | | | | | | | | | | | | | | | | | | | | | | | | | |
| 5 | 0.5 | 0.7 | 0.9 | 1.3 | | | | | | | | | | | | | | | | | | | | | | | | | | | | | | | | | | | | | | | | | | | | | | | | | | | | | | | | | | | | | | | | | | | | | | | | | | | | | | | | | | | | | | | | | | | | | | | | | | | | | | | | | | | | | | | | | | | | | | | | | | | | | | | | | | | | | | | | | | | | | | | | | | | | | | | | | | | | | | | | | | | | | | | | | | | | | | | | | | | | | | | | | | | | | | | | | | | | | | | | | | | | | | | | | | | | | | | | | | | | | | | | | | | | | | | | | | | | | | | | | | | | | | | | | | | | | | | | | | | | | | | | | | | | | | | | | | | | | | | | | | | | | | | | | | | | | | | | | | | | | | | | | | | | | | | | | | | | | | | | | | | | | | | | | | | | | | | | | | | | | | | | | | | | | | | | | | | | | | | | | | | | | | | | | | | | | | | | | | | | | | | | | | | | | | | | | | | | | | | | | | | | | | | | | | | | | | | | | | | | | | | | | | | | | | | | | | | | | | | | | | | | | | | | | | | | | | | | | | | | | | | | | | | | | | | | | | | | | | | | | | | | | | | | | | | | | | | | | | | | | | | | | | | | | | | | | | | | | | | | | | | | | | | | | | | | | | | | | | | | | | | | | | | | | | | | | | | | | | | | | | | | | | | | | | | | | | |
| 7 | 0.9 | 1.2 | 1.5 | 2.1 | | | | | | | | | | | | | | | | | | | | | | | | | | | | | | | | | | | | | | | | | | | | | | | | | | | | | | | | | | | | | | | | | | | | | | | | | | | | | | | | | | | | | | | | | | | | | | | | | | | | | | | | | | | | | | | | | | | | | | | | | | | | | | | | | | | | | | | | | | | | | | | | | | | | | | | | | | | | | | | | | | | | | | | | | | | | | | | | | | | | | | | | | | | | | | | | | | | | | | | | | | | | | | | | | | | | | | | | | | | | | | | | | | | | | | | | | | | | | | | | | | | | | | | | | | | | | | | | | | | | | | | | | | | | | | | | | | | | | | | | | | | | | | | | | | | | | | | | | | | | | | | | | | | | | | | | | | | | | | | | | | | | | | | | | | | | | | | | | | | | | | | | | | | | | | | | | | | | | | | | | | | | | | | | | | | | | | | | | | | | | | | | | | | | | | | | | | | | | | | | | | | | | | | | | | | | | | | | | | | | | | | | | | | | | | | | | | | | | | | | | | | | | | | | | | | | | | | | | | | | | | | | | | | | | | | | | | | | | | | | | | | | | | | | | | | | | | | | | | | | | | | | | | | | | | | | | | | | | | | | | | | | | | | | | | | | | | | | | | | | | | | | | | | | | | | | | | | | | | | | | | | | | | | | | | | | | | |
| 9 | 1.4 | 1.8 | 2.2 | 3.0 | | | | | | | | | | | | | | | | | | | | | | | | | | | | | | | | | | | | | | | | | | | | | | | | | | | | | | | | | | | | | | | | | | | | | | | | | | | | | | | | | | | | | | | | | | | | | | | | | | | | | | | | | | | | | | | | | | | | | | | | | | | | | | | | | | | | | | | | | | | | | | | | | | | | | | | | | | | | | | | | | | | | | | | | | | | | | | | | | | | | | | | | | | | | | | | | | | | | | | | | | | | | | | | | | | | | | | | | | | | | | | | | | | | | | | | | | | | | | | | | | | | | | | | | | | | | | | | | | | | | | | | | | | | | | | | | | | | | | | | | | | | | | | | | | | | | | | | | | | | | | | | | | | | | | | | | | | | | | | | | | | | | | | | | | | | | | | | | | | | | | | | | | | | | | | | | | | | | | | | | | | | | | | | | | | | | | | | | | | | | | | | | | | | | | | | | | | | | | | | | | | | | | | | | | | | | | | | | | | | | | | | | | | | | | | | | | | | | | | | | | | | | | | | | | | | | | | | | | | | | | | | | | | | | | | | | | | | | | | | | | | | | | | | | | | | | | | | | | | | | | | | | | | | | | | | | | | | | | | | | | | | | | | | | | | | | | | | | | | | | | | | | | | | | | | | | | | | | | | | | | | | | | | | | | | | | | | |
| 2 | 4 | 6 | 8 | 10 | | | | | | | | | | | | | | | | | | | | | | | | | | | | | | | | | | | | | | | | | | | | | | | | | | | | | | | | | | | | | | | | | | | | | | | | | | | | | | | | | | | | | | | | | | | | | | | | | | | | | | | | | | | | | | | | | | | | | | | | | | | | | | | | | | | | | | | | | | | | | | | | | | | | | | | | | | | | | | | | | | | | | | | | | | | | | | | | | | | | | | | | | | | | | | | | | | | | | | | | | | | | | | | | | | | | | | | | | | | | | | | | | | | | | | | | | | | | | | | | | | | | | | | | | | | | | | | | | | | | | | | | | | | | | | | | | | | | | | | | | | | | | | | | | | | | | | | | | | | | | | | | | | | | | | | | | | | | | | | | | | | | | | | | | | | | | | | | | | | | | | | | | | | | | | | | | | | | | | | | | | | | | | | | | | | | | | | | | | | | | | | | | | | | | | | | | | | | | | | | | | | | | | | | | | | | | | | | | | | | | | | | | | | | | | | | | | | | | | | | | | | | | | | | | | | | | | | | | | | | | | | | | | | | | | | | | | | | | | | | | | | | | | | | | | | | | | | | | | | | | | | | | | | | | | | | | | | | | | | | | | | | | | | | | | | | | | | | | | | | | | | | | | | | | | | | | | | | | | | | | | | | | | | | | | | | | | |
| 1 | 0.4 | 0.6 | 0.8 | 1.2 | | | | | | | | | | | | | | | | | | | | | | | | | | | | | | | | | | | | | | | | | | | | | | | | | | | | | | | | | | | | | | | | | | | | | | | | | | | | | | | | | | | | | | | | | | | | | | | | | | | | | | | | | | | | | | | | | | | | | | | | | | | | | | | | | | | | | | | | | | | | | | | | | | | | | | | | | | | | | | | | | | | | | | | | | | | | | | | | | | | | | | | | | | | | | | | | | | | | | | | | | | | | | | | | | | | | | | | | | | | | | | | | | | | | | | | | | | | | | | | | | | | | | | | | | | | | | | | | | | | | | | | | | | | | | | | | | | | | | | | | | | | | | | | | | | | | | | | | | | | | | | | | | | | | | | | | | | | | | | | | | | | | | | | | | | | | | | | | | | | | | | | | | | | | | | | | | | | | | | | | | | | | | | | | | | | | | | | | | | | | | | | | | | | | | | | | | | | | | | | | | | | | | | | | | | | | | | | | | | | | | | | | | | | | | | | | | | | | | | | | | | | | | | | | | | | | | | | | | | | | | | | | | | | | | | | | | | | | | | | | | | | | | | | | | | | | | | | | | | | | | | | | | | | | | | | | | | | | | | | | | | | | | | | | | | | | | | | | | | | | | | | | | | | | | | | | | | | | | | | | | | | | | | | | | | | | | | |
| 4 | 1.1 | 1.4 | 2.0 | 1.6 | | | | | | | | | | | | | | | | | | | | | | | | | | | | | | | | | | | | | | | | | | | | | | | | | | | | | | | | | | | | | | | | | | | | | | | | | | | | | | | | | | | | | | | | | | | | | | | | | | | | | | | | | | | | | | | | | | | | | | | | | | | | | | | | | | | | | | | | | | | | | | | | | | | | | | | | | | | | | | | | | | | | | | | | | | | | | | | | | | | | | | | | | | | | | | | | | | | | | | | | | | | | | | | | | | | | | | | | | | | | | | | | | | | | | | | | | | | | | | | | | | | | | | | | | | | | | | | | | | | | | | | | | | | | | | | | | | | | | | | | | | | | | | | | | | | | | | | | | | | | | | | | | | | | | | | | | | | | | | | | | | | | | | | | | | | | | | | | | | | | | | | | | | | | | | | | | | | | | | | | | | | | | | | | | | | | | | | | | | | | | | | | | | | | | | | | | | | | | | | | | | | | | | | | | | | | | | | | | | | | | | | | | | | | | | | | | | | | | | | | | | | | | | | | | | | | | | | | | | | | | | | | | | | | | | | | | | | | | | | | | | | | | | | | | | | | | | | | | | | | | | | | | | | | | | | | | | | | | | | | | | | | | | | | | | | | | | | | | | | | | | | | | | | | | | | | | | | | | | | | | | | | | | | | | | | | | | |
| 6 | 1.7 | 2.1 | 2.9 | ... | | | | | | | | | | | | | | | | | | | | | | | | | | | | | | | | | | | | | | | | | | | | | | | | | | | | | | | | | | | | | | | | | | | | | | | | | | | | | | | | | | | | | | | | | | | | | | | | | | | | | | | | | | | | | | | | | | | | | | | | | | | | | | | | | | | | | | | | | | | | | | | | | | | | | | | | | | | | | | | | | | | | | | | | | | | | | | | | | | | | | | | | | | | | | | | | | | | | | | | | | | | | | | | | | | | | | | | | | | | | | | | | | | | | | | | | | | | | | | | | | | | | | | | | | | | | | | | | | | | | | | | | | | | | | | | | | | | | | | | | | | | | | | | | | | | | | | | | | | | | | | | | | | | | | | | | | | | | | | | | | | | | | | | | | | | | | | | | | | | | | | | | | | | | | | | | | | | | | | | | | | | | | | | | | | | | | | | | | | | | | | | | | | | | | | | | | | | | | | | | | | | | | | | | | | | | | | | | | | | | | | | | | | | | | | | | | | | | | | | | | | | | | | | | | | | | | | | | | | | | | | | | | | | | | | | | | | | | | | | | | | | | | | | | | | | | | | | | | | | | | | | | | | | | | | | | | | | | | | | | | | | | | | | | | | | | | | | | | | | | | | | | | | | | | | | | | | | | | | | | | | | | | | | | | | | | | | |
| 8 | ... | ... | ... | ... | | | | | | | | | | | | | | | | | | | | | | | | | | | | | | | | | | | | | | | | | | | | | | | | | | | | | | | | | | | | | | | | | | | | | | | | | | | | | | | | | | | | | | | | | | | | | | | | | | | | | | | | | | | | | | | | | | | | | | | | | | | | | | | | | | | | | | | | | | | | | | | | | | | | | | | | | | | | | | | | | | | | | | | | | | | | | | | | | | | | | | | | | | | | | | | | | | | | | | | | | | | | | | | | | | | | | | | | | | | | | | | | | | | | | | | | | | | | | | | | | | | | | | | | | | | | | | | | | | | | | | | | | | | | | | | | | | | | | | | | | | | | | | | | | | | | | | | | | | | | | | | | | | | | | | | | | | | | | | | | | | | | | | | | | | | | | | | | | | | | | | | | | | | | | | | | | | | | | | | | | | | | | | | | | | | | | | | | | | | | | | | | | | | | | | | | | | | | | | | | | | | | | | | | | | | | | | | | | | | | | | | | | | | | | | | | | | | | | | | | | | | | | | | | | | | | | | | | | | | | | | | | | | | | | | | | | | | | | | | | | | | | | | | | | | | | | | | | | | | | | | | | | | | | | | | | | | | | | | | | | | | | | | | | | | | | | | | | | | | | | | | | | | | | | | | | | | | | | | | | | | | | | | | | | | | | | | |
| 2 | 4 | 6 | 8 | 10 | | | | | | | | | | | | | | | | | | | | | | | | | | | | | | | | | | | | | | | | | | | | | | | | | | | | | | | | | | | | | | | | | | | | | | | | | | | | | | | | | | | | | | | | | | | | | | | | | | | | | | | | | | | | | | | | | | | | | | | | | | | | | | | | | | | | | | | | | | | | | | | | | | | | | | | | | | | | | | | | | | | | | | | | | | | | | | | | | | | | | | | | | | | | | | | | | | | | | | | | | | | | | | | | | | | | | | | | | | | | | | | | | | | | | | | | | | | | | | | | | | | | | | | | | | | | | | | | | | | | | | | | | | | | | | | | | | | | | | | | | | | | | | | | | | | | | | | | | | | | | | | | | | | | | | | | | | | | | | | | | | | | | | | | | | | | | | | | | | | | | | | | | | | | | | | | | | | | | | | | | | | | | | | | | | | | | | | | | | | | | | | | | | | | | | | | | | | | | | | | | | | | | | | | | | | | | | | | | | | | | | | | | | | | | | | | | | | | | | | | | | | | | | | | | | | | | | | | | | | | | | | | | | | | | | | | | | | | | | | | | | | | | | | | | | | | | | | | | | | | | | | | | | | | | | | | | | | | | | | | | | | | | | | | | | | | | | | | | | | | | | | | | | | | | | | | | | | | | | | | | | | | | | | | | | | | | | |
| 0.2 | 0.3 | 0.4 | 0.6 | 0.8 | | | | | | | | | | | | | | | | | | | | | | | | | | | | | | | | | | | | | | | | | | | | | | | | | | | | | | | | | | | | | | | | | | | | | | | | | | | | | | | | | | | | | | | | | | | | | | | | | | | | | | | | | | | | | | | | | | | | | | | | | | | | | | | | | | | | | | | | | | | | | | | | | | | | | | | | | | | | | | | | | | | | | | | | | | | | | | | | | | | | | | | | | | | | | | | | | | | | | | | | | | | | | | | | | | | | | | | | | | | | | | | | | | | | | | | | | | | | | | | | | | | | | | | | | | | | | | | | | | | | | | | | | | | | | | | | | | | | | | | | | | | | | | | | | | | | | | | | | | | | | | | | | | | | | | | | | | | | | | | | | | | | | | | | | | | | | | | | | | | | | | | | | | | | | | | | | | | | | | | | | | | | | | | | | | | | | | | | | | | | | | | | | | | | | | | | | | | | | | | | | | | | | | | | | | | | | | | | | | | | | | | | | | | | | | | | | | | | | | | | | | | | | | | | | | | | | | | | | | | | | | | | | | | | | | | | | | | | | | | | | | | | | | | | | | | | | | | | | | | | | | | | | | | | | | | | | | | | | | | | | | | | | | | | | | | | | | | | | | | | | | | | | | | | | | | | | | | | | | | | | | | | | | | | | | | | | | |
| 2 | 4 | 6 | 8 | 10 | | | | | | | | | | | | | | | | | | | | | | | | | | | | | | | | | | | | | | | | | | | | | | | | | | | | | | | | | | | | | | | | | | | | | | | | | | | | | | | | | | | | | | | | | | | | | | | | | | | | | | | | | | | | | | | | | | | | | | | | | | | | | | | | | | | | | | | | | | | | | | | | | | | | | | | | | | | | | | | | | | | | | | | | | | | | | | | | | | | | | | | | | | | | | | | | | | | | | | | | | | | | | | | | | | | | | | | | | | | | | | | | | | | | | | | | | | | | | | | | | | | | | | | | | | | | | | | | | | | | | | | | | | | | | | | | | | | | | | | | | | | | | | | | | | | | | | | | | | | | | | | | | | | | | | | | | | | | | | | | | | | | | | | | | | | | | | | | | | | | | | | | | | | | | | | | | | | | | | | | | | | | | | | | | | | | | | | | | | | | | | | | | | | | | | | | | | | | | | | | | | | | | | | | | | | | | | | | | | | | | | | | | | | | | | | | | | | | | | | | | | | | | | | | | | | | | | | | | | | | | | | | | | | | | | | | | | | | | | | | | | | | | | | | | | | | | | | | | | | | | | | | | | | | | | | | | | | | | | | | | | | | | | | | | | | | | | | | | | | | | | | | | | | | | | | | | | | | | | | | | | | | | | | | | | | | | | |
| 2.6 | 2.9 | 3.4 | 4.1 | 5.1 | | | | | | | | | | | | | | | | | | | | | | | | | | | | | | | | | | | | | | | | | | | | | | | | | | | | | | | | | | | | | | | | | | | | | | | | | | | | | | | | | | | | | | | | | | | | | | | | | | | | | | | | | | | | | | | | | | | | | | | | | | | | | | | | | | | | | | | | | | | | | | | | | | | | | | | | | | | | | | | | | | | | | | | | | | | | | | | | | | | | | | | | | | | | | | | | | | | | | | | | | | | | | | | | | | | | | | | | | | | | | | | | | | | | | | | | | | | | | | | | | | | | | | | | | | | | | | | | | | | | | | | | | | | | | | | | | | | | | | | | | | | | | | | | | | | | | | | | | | | | | | | | | | | | | | | | | | | | | | | | | | | | | | | | | | | | | | | | | | | | | | | | | | | | | | | | | | | | | | | | | | | | | | | | | | | | | | | | | | | | | | | | | | | | | | | | | | | | | | | | | | | | | | | | | | | | | | | | | | | | | | | | | | | | | | | | | | | | | | | | | | | | | | | | | | | | | | | | | | | | | | | | | | | | | | | | | | | | | | | | | | | | | | | | | | | | | | | | | | | | | | | | | | | | | | | | | | | | | | | | | | | | | | | | | | | | | | | | | | | | | | | | | | | | | | | | | | | | | | | | | | | | | | | | | | | | | | |
| 2 | 4 | 6 | 8 | 10 | | | | | | | | | | | | | | | | | | | | | | | | | | | | | | | | | | | | | | | | | | | | | | | | | | | | | | | | | | | | | | | | | | | | | | | | | | | | | | | | | | | | | | | | | | | | | | | | | | | | | | | | | | | | | | | | | | | | | | | | | | | | | | | | | | | | | | | | | | | | | | | | | | | | | | | | | | | | | | | | | | | | | | | | | | | | | | | | | | | | | | | | | | | | | | | | | | | | | | | | | | | | | | | | | | | | | | | | | | | | | | | | | | | | | | | | | | | | | | | | | | | | | | | | | | | | | | | | | | | | | | | | | | | | | | | | | | | | | | | | | | | | | | | | | | | | | | | | | | | | | | | | | | | | | | | | | | | | | | | | | | | | | | | | | | | | | | | | | | | | | | | | | | | | | | | | | | | | | | | | | | | | | | | | | | | | | | | | | | | | | | | | | | | | | | | | | | | | | | | | | | | | | | | | | | | | | | | | | | | | | | | | | | | | | | | | | | | | | | | | | | | | | | | | | | | | | | | | | | | | | | | | | | | | | | | | | | | | | | | | | | | | | | | | | | | | | | | | | | | | | | | | | | | | | | | | | | | | | | | | | | | | | | | | | | | | | | | | | | | | | | | | | | | | | | | | | | | | | | | | | | | | | | | | | | | | | | |
| 0.0 | 0.2 | 0.4 | 0.6 | 0.8 | | | | | | | | | | | | | | | | | | | | | | | | | | | | | | | | | | | | | | | | | | | | | | | | | | | | | | | | | | | | | | | | | | | | | | | | | | | | | | | | | | | | | | | | | | | | | | | | | | | | | | | | | | | | | | | | | | | | | | | | | | | | | | | | | | | | | | | | | | | | | | | | | | | | | | | | | | | | | | | | | | | | | | | | | | | | | | | | | | | | | | | | | | | | | | | | | | | | | | | | | | | | | | | | | | | | | | | | | | | | | | | | | | | | | | | | | | | | | | | | | | | | | | | | | | | | | | | | | | | | | | | | | | | | | | | | | | | | | | | | | | | | | | | | | | | | | | | | | | | | | | | | | | | | | | | | | | | | | | | | | | | | | | | | | | | | | | | | | | | | | | | | | | | | | | | | | | | | | | | | | | | | | | | | | | | | | | | | | | | | | | | | | | | | | | | | | | | | | | | | | | | | | | | | | | | | | | | | | | | | | | | | | | | | | | | | | | | | | | | | | | | | | | | | | | | | | | | | | | | | | | | | | | | | | | | | | | | | | | | | | | | | | | | | | | | | | | | | | | | | | | | | | | | | | | | | | | | | | | | | | | | | | | | | | | | | | | | | | | | | | | | | | | | | | | | | | | | | | | | | | | | | | | | | | | | | | | |
| 2 | 4 | 6 | 8 | 10 | | | | | | | | | | | | | | | | | | | | | | | | | | | | | | | | | | | | | | | | | | | | | | | | | | | | | | | | | | | | | | | | | | | | | | | | | | | | | | | | | | | | | | | | | | | | | | | | | | | | | | | | | | | | | | | | | | | | | | | | | | | | | | | | | | | | | | | | | | | | | | | | | | | | | | | | | | | | | | | | | | | | | | | | | | | | | | | | | | | | | | | | | | | | | | | | | | | | | | | | | | | | | | | | | | | | | | | | | | | | | | | | | | | | | | | | | | | | | | | | | | | | | | | | | | | | | | | | | | | | | | | | | | | | | | | | | | | | | | | | | | | | | | | | | | | | | | | | | | | | | | | | | | | | | | | | | | | | | | | | | | | | | | | | | | | | | | | | | | | | | | | | | | | | | | | | | | | | | | | | | | | | | | | | | | | | | | | | | | | | | | | | | | | | | | | | | | | | | | | | | | | | | | | | | | | | | | | | | | | | | | | | | | | | | | | | | | | | | | | | | | | | | | | | | | | | | | | | | | | | | | | | | | | | | | | | | | | | | | | | | | | | | | | | | | | | | | | | | | | | | | | | | | | | | | | | | | | | | | | | | | | | | | | | | | | | | | | | | | | | | | | | | | | | | | | | | | | | | | | | | | | | | | | | | | | | | | |
| 1 | 0 | 0 | 0 | 0 | | | | | | | | | | | | | | | | | | | | | | | | | | | | | | | | | | | | | | | | | | | | | | | | | | | | | | | | | | | | | | | | | | | | | | | | | | | | | | | | | | | | | | | | | | | | | | | | | | | | | | | | | | | | | | | | | | | | | | | | | | | | | | | | | | | | | | | | | | | | | | | | | | | | | | | | | | | | | | | | | | | | | | | | | | | | | | | | | | | | | | | | | | | | | | | | | | | | | | | | | | | | | | | | | | | | | | | | | | | | | | | | | | | | | | | | | | | | | | | | | | | | | | | | | | | | | | | | | | | | | | | | | | | | | | | | | | | | | | | | | | | | | | | | | | | | | | | | | | | | | | | | | | | | | | | | | | | | | | | | | | | | | | | | | | | | | | | | | | | | | | | | | | | | | | | | | | | | | | | | | | | | | | | | | | | | | | | | | | | | | | | | | | | | | | | | | | | | | | | | | | | | | | | | | | | | | | | | | | | | | | | | | | | | | | | | | | | | | | | | | | | | | | | | | | | | | | | | | | | | | | | | | | | | | | | | | | | | | | | | | | | | | | | | | | | | | | | | | | | | | | | | | | | | | | | | | | | | | | | | | | | | | | | | | | | | | | | | | | | | | | | | | | | | | | | | | | | | | | | | | | | | | | | | | | | | | | |
| 3 | 0.3 | 0.4 | 0.5 | 0.7 | | | | | | | | | | | | | | | | | | | | | | | | | | | | | | | | | | | | | | | | | | | | | | | | | | | | | | | | | | | | | | | | | | | | | | | | | | | | | | | | | | | | | | | | | | | | | | | | | | | | | | | | | | | | | | | | | | | | | | | | | | | | | | | | | | | | | | | | | | | | | | | | | | | | | | | | | | | | | | | | | | | | | | | | | | | | | | | | | | | | | | | | | | | | | | | | | | | | | | | | | | | | | | | | | | | | | | | | | | | | | | | | | | | | | | | | | | | | | | | | | | | | | | | | | | | | | | | | | | | | | | | | | | | | | | | | | | | | | | | | | | | | | | | | | | | | | | | | | | | | | | | | | | | | | | | | | | | | | | | | | | | | | | | | | | | | | | | | | | | | | | | | | | | | | | | | | | | | | | | | | | | | | | | | | | | | | | | | | | | | | | | | | | | | | | | | | | | | | | | | | | | | | | | | | | | | | | | | | | | | | | | | | | | | | | | | | | | | | | | | | | | | | | | | | | | | | | | | | | | | | | | | | | | | | | | | | | | | | | | | | | | | | | | | | | | | | | | | | | | | | | | | | | | | | | | | | | | | | | | | | | | | | | | | | | | | | | | | | | | | | | | | | | | | | | | | | | | | | | | | | | | | | | | | | | | | | | |
| 5 | 0.7 | 0.9 | 1.1 | 1.5 | | | | | | | | | | | | | | | | | | | | | | | | | | | | | | | | | | | | | | | | | | | | | | | | | | | | | | | | | | | | | | | | | | | | | | | | | | | | | | | | | | | | | | | | | | | | | | | | | | | | | | | | | | | | | | | | | | | | | | | | | | | | | | | | | | | | | | | | | | | | | | | | | | | | | | | | | | | | | | | | | | | | | | | | | | | | | | | | | | | | | | | | | | | | | | | | | | | | | | | | | | | | | | | | | | | | | | | | | | | | | | | | | | | | | | | | | | | | | | | | | | | | | | | | | | | | | | | | | | | | | | | | | | | | | | | | | | | | | | | | | | | | | | | | | | | | | | | | | | | | | | | | | | | | | | | | | | | | | | | | | | | | | | | | | | | | | | | | | | | | | | | | | | | | | | | | | | | | | | | | | | | | | | | | | | | | | | | | | | | | | | | | | | | | | | | | | | | | | | | | | | | | | | | | | | | | | | | | | | | | | | | | | | | | | | | | | | | | | | | | | | | | | | | | | | | | | | | | | | | | | | | | | | | | | | | | | | | | | | | | | | | | | | | | | | | | | | | | | | | | | | | | | | | | | | | | | | | | | | | | | | | | | | | | | | | | | | | | | | | | | | | | | | | | | | | | | | | | | | | | | | | | | | | | | | | | | | |
| 7 | 1.2 | 1.5 | 1.8 | 2.4 | | | | | | | | | | | | | | | | | | | | | | | | | | | | | | | | | | | | | | | | | | | | | | | | | | | | | | | | | | | | | | | | | | | | | | | | | | | | | | | | | | | | | | | | | | | | | | | | | | | | | | | | | | | | | | | | | | | | | | | | | | | | | | | | | | | | | | | | | | | | | | | | | | | | | | | | | | | | | | | | | | | | | | | | | | | | | | | | | | | | | | | | | | | | | | | | | | | | | | | | | | | | | | | | | | | | | | | | | | | | | | | | | | | | | | | | | | | | | | | | | | | | | | | | | | | | | | | | | | | | | | | | | | | | | | | | | | | | | | | | | | | | | | | | | | | | | | | | | | | | | | | | | | | | | | | | | | | | | | | | | | | | | | | | | | | | | | | | | | | | | | | | | | | | | | | | | | | | | | | | | | | | | | | | | | | | | | | | | | | | | | | | | | | | | | | | | | | | | | | | | | | | | | | | | | | | | | | | | | | | | | | | | | | | | | | | | | | | | | | | | | | | | | | | | | | | | | | | | | | | | | | | | | | | | | | | | | | | | | | | | | | | | | | | | | | | | | | | | | | | | | | | | | | | | | | | | | | | | | | | | | | | | | | | | | | | | | | | | | | | | | | | | | | | | | | | | | | | | | | | | | | | | | | | | | | | | | |
| 9 | 1.8 | 2.2 | 2.6 | 3.4 | | | | | | | | | | | | | | | | | | | | | | | | | | | | | | | | | | | | | | | | | | | | | | | | | | | | | | | | | | | | | | | | | | | | | | | | | | | | | | | | | | | | | | | | | | | | | | | | | | | | | | | | | | | | | | | | | | | | | | | | | | | | | | | | | | | | | | | | | | | | | | | | | | | | | | | | | | | | | | | | | | | | | | | | | | | | | | | | | | | | | | | | | | | | | | | | | | | | | | | | | | | | | | | | | | | | | | | | | | | | | | | | | | | | | | | | | | | | | | | | | | | | | | | | | | | | | | | | | | | | | | | | | | | | | | | | | | | | | | | | | | | | | | | | | | | | | | | | | | | | | | | | | | | | | | | | | | | | | | | | | | | | | | | | | | | | | | | | | | | | | | | | | | | | | | | | | | | | | | | | | | | | | | | | | | | | | | | | | | | | | | | | | | | | | | | | | | | | | | | | | | | | | | | | | | | | | | | | | | | | | | | | | | | | | | | | | | | | | | | | | | | | | | | | | | | | | | | | | | | | | | | | | | | | | | | | | | | | | | | | | | | | | | | | | | | | | | | | | | | | | | | | | | | | | | | | | | | | | | | | | | | | | | | | | | | | | | | | | | | | | | | | | | | | | | | | | | | | | | | | | | | | | | | | | | | | | | |
| 2 | 4 | 6 | 8 | 10 | | | | | | | | | | | | | | | | | | | | | | | | | | | | | | | | | | | | | | | | | | | | | | | | | | | | | | | | | | | | | | | | | | | | | | | | | | | | | | | | | | | | | | | | | | | | | | | | | | | | | | | | | | | | | | | | | | | | | | | | | | | | | | | | | | | | | | | | | | | | | | | | | | | | | | | | | | | | | | | | | | | | | | | | | | | | | | | | | | | | | | | | | | | | | | | | | | | | | | | | | | | | | | | | | | | | | | | | | | | | | | | | | | | | | | | | | | | | | | | | | | | | | | | | | | | | | | | | | | | | | | | | | | | | | | | | | | | | | | | | | | | | | | | | | | | | | | | | | | | | | | | | | | | | | | | | | | | | | | | | | | | | | | | | | | | | | | | | | | | | | | | | | | | | | | | | | | | | | | | | | | | | | | | | | | | | | | | | | | | | | | | | | | | | | | | | | | | | | | | | | | | | | | | | | | | | | | | | | | | | | | | | | | | | | | | | | | | | | | | | | | | | | | | | | | | | | | | | | | | | | | | | | | | | | | | | | | | | | | | | | | | | | | | | | | | | | | | | | | | | | | | | | | | | | | | | | | | | | | | | | | | | | | | | | | | | | | | | | | | | | | | | | | | | | | | | | | | | | | | | | | | | | | | | | | | | | | |
| 1 | 0.6 | 0.8 | 1.0 | 1.4 | | | | | | | | | | | | | | | | | | | | | | | | | | | | | | | | | | | | | | | | | | | | | | | | | | | | | | | | | | | | | | | | | | | | | | | | | | | | | | | | | | | | | | | | | | | | | | | | | | | | | | | | | | | | | | | | | | | | | | | | | | | | | | | | | | | | | | | | | | | | | | | | | | | | | | | | | | | | | | | | | | | | | | | | | | | | | | | | | | | | | | | | | | | | | | | | | | | | | | | | | | | | | | | | | | | | | | | | | | | | | | | | | | | | | | | | | | | | | | | | | | | | | | | | | | | | | | | | | | | | | | | | | | | | | | | | | | | | | | | | | | | | | | | | | | | | | | | | | | | | | | | | | | | | | | | | | | | | | | | | | | | | | | | | | | | | | | | | | | | | | | | | | | | | | | | | | | | | | | | | | | | | | | | | | | | | | | | | | | | | | | | | | | | | | | | | | | | | | | | | | | | | | | | | | | | | | | | | | | | | | | | | | | | | | | | | | | | | | | | | | | | | | | | | | | | | | | | | | | | | | | | | | | | | | | | | | | | | | | | | | | | | | | | | | | | | | | | | | | | | | | | | | | | | | | | | | | | | | | | | | | | | | | | | | | | | | | | | | | | | | | | | | | | | | | | | | | | | | | | | | | | | | | | | | | | | | | |
| 4 | 1.4 | 1.7 | 2.3 | ... | | | | | | | | | | | | | | | | | | | | | | | | | | | | | | | | | | | | | | | | | | | | | | | | | | | | | | | | | | | | | | | | | | | | | | | | | | | | | | | | | | | | | | | | | | | | | | | | | | | | | | | | | | | | | | | | | | | | | | | | | | | | | | | | | | | | | | | | | | | | | | | | | | | | | | | | | | | | | | | | | | | | | | | | | | | | | | | | | | | | | | | | | | | | | | | | | | | | | | | | | | | | | | | | | | | | | | | | | | | | | | | | | | | | | | | | | | | | | | | | | | | | | | | | | | | | | | | | | | | | | | | | | | | | | | | | | | | | | | | | | | | | | | | | | | | | | | | | | | | | | | | | | | | | | | | | | | | | | | | | | | | | | | | | | | | | | | | | | | | | | | | | | | | | | | | | | | | | | | | | | | | | | | | | | | | | | | | | | | | | | | | | | | | | | | | | | | | | | | | | | | | | | | | | | | | | | | | | | | | | | | | | | | | | | | | | | | | | | | | | | | | | | | | | | | | | | | | | | | | | | | | | | | | | | | | | | | | | | | | | | | | | | | | | | | | | | | | | | | | | | | | | | | | | | | | | | | | | | | | | | | | | | | | | | | | | | | | | | | | | | | | | | | | | | | | | | | | | | | | | | | | | | | | | | | | | | | |
| 6 | ... | ... | ... | ... | | | | | | | | | | | | | | | | | | | | | | | | | | | | | | | | | | | | | | | | | | | | | | | | | | | | | | | | | | | | | | | | | | | | | | | | | | | | | | | | | | | | | | | | | | | | | | | | | | | | | | | | | | | | | | | | | | | | | | | | | | | | | | | | | | | | | | | | | | | | | | | | | | | | | | | | | | | | | | | | | | | | | | | | | | | | | | | | | | | | | | | | | | | | | | | | | | | | | | | | | | | | | | | | | | | | | | | | | | | | | | | | | | | | | | | | | | | | | | | | | | | | | | | | | | | | | | | | | | | | | | | | | | | | | | | | | | | | | | | | | | | | | | | | | | | | | | | | | | | | | | | | | | | | | | | | | | | | | | | | | | | | | | | | | | | | | | | | | | | | | | | | | | | | | | | | | | | | | | | | | | | | | | | | | | | | | | | | | | | | | | | | | | | | | | | | | | | | | | | | | | | | | | | | | | | | | | | | | | | | | | | | | | | | | | | | | | | | | | | | | | | | | | | | | | | | | | | | | | | | | | | | | | | | | | | | | | | | | | | | | | | | | | | | | | | | | | | | | | | | | | | | | | | | | | | | | | | | | | | | | | | | | | | | | | | | | | | | | | | | | | | | | | | | | | | | | | | | | | | | | | | | | | | | | | | | | | |
| 8 | ... | ... | ... | ... | | | | | | | | | | | | | | | | | | | | | | | | | | | | | | | | | | | | | | | | | | | | | | | | | | | | | | | | | | | | | | | | | | | | | | | | | | | | | | | | | | | | | | | | | | | | | | | | | | | | | | | | | | | | | | | | | | | | | | | | | | | | | | | | | | | | | | | | | | | | | | | | | | | | | | | | | | | | | | | | | | | | | | | | | | | | | | | | | | | | | | | | | | | | | | | | | | | | | | | | | | | | | | | | | | | | | | | | | | | | | | | | | | | | | | | | | | | | | | | | | | | | | | | | | | | | | | | | | | | | | | | | | | | | | | | | | | | | | | | | | | | | | | | | | | | | | | | | | | | | | | | | | | | | | | | | | | | | | | | | | | | | | | | | | | | | | | | | | | | | | | | | | | | | | | | | | | | | | | | | | | | | | | | | | | | | | | | | | | | | | | | | | | | | | | | | | | | | | | | | | | | | | | | | | | | | | | | | | | | | | | | | | | | | | | | | | | | | | | | | | | | | | | | | | | | | | | | | | | | | | | | | | | | | | | | | | | | | | | | | | | | | | | | | | | | | | | | | | | | | | | | | | | | | | | | | | | | | | | | | | | | | | | | | | | | | | | | | | | | | | | | | | | | | | | | | | | | | | | | | | | | | | | | | | | | | | | |
| 2 | 4 | 6 | 8 | 10 | | | | | | | | | | | | | | | | | | | | | | | | | | | | | | | | | | | | | | | | | | | | | | | | | | | | | | | | | | | | | | | | | | | | | | | | | | | | | | | | | | | | | | | | | | | | | | | | | | | | | | | | | | | | | | | | | | | | | | | | | | | | | | | | | | | | | | | | | | | | | | | | | | | | | | | | | | | | | | | | | | | | | | | | | | | | | | | | | | | | | | | | | | | | | | | | | | | | | | | | | | | | | | | | | | | | | | | | | | | | | | | | | | | | | | | | | | | | | | | | | | | | | | | | | | | | | | | | | | | | | | | | | | | | | | | | | | | | | | | | | | | | | | | | | | | | | | | | | | | | | | | | | | | | | | | | | | | | | | | | | | | | | | | | | | | | | | | | | | | | | | | | | | | | | | | | | | | | | | | | | | | | | | | | | | | | | | | | | | | | | | | | | | | | | | | | | | | | | | | | | | | | | | | | | | | | | | | | | | | | | | | | | | | | | | | | | | | | | | | | | | | | | | | | | | | | | | | | | | | | | | | | | | | | | | | | | | | | | | | | | | | | | | | | | | | | | | | | | | | | | | | | | | | | | | | | | | | | | | | | | | | | | | | | | | | | | | | | | | | | | | | | | | | | | | | | | | | | | | | | | | | | | | | | | | | | | | |
| 0.3 | 0.4 | 0.5 | 0.7 | 0.9 | | | | | | | | | | | | | | | | | | | | | | | | | | | | | | | | | | | | | | | | | | | | | | | | | | | | | | | | | | | | | | | | | | | | | | | | | | | | | | | | | | | | | | | | | | | | | | | | | | | | | | | | | | | | | | | | | | | | | | | | | | | | | | | | | | | | | | | | | | | | | | | | | | | | | | | | | | | | | | | | | | | | | | | | | | | | | | | | | | | | | | | | | | | | | | | | | | | | | | | | | | | | | | | | | | | | | | | | | | | | | | | | | | | | | | | | | | | | | | | | | | | | | | | | | | | | | | | | | | | | | | | | | | | | | | | | | | | | | | | | | | | | | | | | | | | | | | | | | | | | | | | | | | | | | | | | | | | | | | | | | | | | | | | | | | | | | | | | | | | | | | | | | | | | | | | | | | | | | | | | | | | | | | | | | | | | | | | | | | | | | | | | | | | | | | | | | | | | | | | | | | | | | | | | | | | | | | | | | | | | | | | | | | | | | | | | | | | | | | | | | | | | | | | | | | | | | | | | | | | | | | | | | | | | | | | | | | | | | | | | | | | | | | | | | | | | | | | | | | | | | | | | | | | | | | | | | | | | | | | | | | | | | | | | | | | | | | | | | | | | | | | | | | | | | | | | | | | | | | | | | | | | | | | | | | | | | | |
| 1 | 3 | 5 | 7 | 9 | | | | | | | | | | | | | | | | | | | | | | | | | | | | | | | | | | | | | | | | | | | | | | | | | | | | | | | | | | | | | | | | | | | | | | | | | | | | | | | | | | | | | | | | | | | | | | | | | | | | | | | | | | | | | | | | | | | | | | | | | | | | | | | | | | | | | | | | | | | | | | | | | | | | | | | | | | | | | | | | | | | | | | | | | | | | | | | | | | | | | | | | | | | | | | | | | | | | | | | | | | | | | | | | | | | | | | | | | | | | | | | | | | | | | | | | | | | | | | | | | | | | | | | | | | | | | | | | | | | | | | | | | | | | | | | | | | | | | | | | | | | | | | | | | | | | | | | | | | | | | | | | | | | | | | | | | | | | | | | | | | | | | | | | | | | | | | | | | | | | | | | | | | | | | | | | | | | | | | | | | | | | | | | | | | | | | | | | | | | | | | | | | | | | | | | | | | | | | | | | | | | | | | | | | | | | | | | | | | | | | | | | | | | | | | | | | | | | | | | | | | | | | | | | | | | | | | | | | | | | | | | | | | | | | | | | | | | | | | | | | | | | | | | | | | | | | | | | | | | | | | | | | | | | | | | | | | | | | | | | | | | | | | | | | | | | | | | | | | | | | | | | | | | | | | | | | | | | | | | | | | | | | | | | | | | | | | |
| 2.6 | 2.9 | 3.4 | 4.1 | 5.1 | | | | | | | | | | | | | | | | | | | | | | | | | | | | | | | | | | | | | | | | | | | | | | | | | | | | | | | | | | | | | | | | | | | | | | | | | | | | | | | | | | | | | | | | | | | | | | | | | | | | | | | | | | | | | | | | | | | | | | | | | | | | | | | | | | | | | | | | | | | | | | | | | | | | | | | | | | | | | | | | | | | | | | | | | | | | | | | | | | | | | | | | | | | | | | | | | | | | | | | | | | | | | | | | | | | | | | | | | | | | | | | | | | | | | | | | | | | | | | | | | | | | | | | | | | | | | | | | | | | | | | | | | | | | | | | | | | | | | | | | | | | | | | | | | | | | | | | | | | | | | | | | | | | | | | | | | | | | | | | | | | | | | | | | | | | | | | | | | | | | | | | | | | | | | | | | | | | | | | | | | | | | | | | | | | | | | | | | | | | | | | | | | | | | | | | | | | | | | | | | | | | | | | | | | | | | | | | | | | | | | | | | | | | | | | | | | | | | | | | | | | | | | | | | | | | | | | | | | | | | | | | | | | | | | | | | | | | | | | | | | | | | | | | | | | | | | | | | | | | | | | | | | | | | | | | | | | | | | | | | | | | | | | | | | | | | | | | | | | | | | | | | | | | | | | | | | | | | | | | | | | | | | | | | | | | | | | |
| 1 | 3 | 5 | 7 | 9 | | | | | | | | | | | | | | | | | | | | | | | | | | | | | | | | | | | | | | | | | | | | | | | | | | | | | | | | | | | | | | | | | | | | | | | | | | | | | | | | | | | | | | | | | | | | | | | | | | | | | | | | | | | | | | | | | | | | | | | | | | | | | | | | | | | | | | | | | | | | | | | | | | | | | | | | | | | | | | | | | | | | | | | | | | | | | | | | | | | | | | | | | | | | | | | | | | | | | | | | | | | | | | | | | | | | | | | | | | | | | | | | | | | | | | | | | | | | | | | | | | | | | | | | | | | | | | | | | | | | | | | | | | | | | | | | | | | | | | | | | | | | | | | | | | | | | | | | | | | | | | | | | | | | | | | | | | | | | | | | | | | | | | | | | | | | | | | | | | | | | | | | | | | | | | | | | | | | | | | | | | | | | | | | | | | | | | | | | | | | | | | | | | | | | | | | | | | | | | | | | | | | | | | | | | | | | | | | | | | | | | | | | | | | | | | | | | | | | | | | | | | | | | | | | | | | | | | | | | | | | | | | | | | | | | | | | | | | | | | | | | | | | | | | | | | | | | | | | | | | | | | | | | | | | | | | | | | | | | | | | | | | | | | | | | | | | | | | | | | | | | | | | | | | | | | | | | | | | | | | | | | | | | | | | | | | | | |
| 0.0 | 0.1 | 0.3 | 0.5 | 0.7 | | | | | | | | | | | | | | | | | | | | | | | | | | | | | | | | | | | | | | | | | | | | | | | | | | | | | | | | | | | | | | | | | | | | | | | | | | | | | | | | | | | | | | | | | | | | | | | | | | | | | | | | | | | | | | | | | | | | | | | | | | | | | | | | | | | | | | | | | | | | | | | | | | | | | | | | | | | | | | | | | | | | | | | | | | | | | | | | | | | | | | | | | | | | | | | | | | | | | | | | | | | | | | | | | | | | | | | | | | | | | | | | | | | | | | | | | | | | | | | | | | | | | | | | | | | | | | | | | | | | | | | | | | | | | | | | | | | | | | | | | | | | | | | | | | | | | | | | | | | | | | | | | | | | | | | | | | | | | | | | | | | | | | | | | | | | | | | | | | | | | | | | | | | | | | | | | | | | | | | | | | | | | | | | | | | | | | | | | | | | | | | | | | | | | | | | | | | | | | | | | | | | | | | | | | | | | | | | | | | | | | | | | | | | | | | | | | | | | | | | | | | | | | | | | | | | | | | | | | | | | | | | | | | | | | | | | | | | | | | | | | | | | | | | | | | | | | | | | | | | | | | | | | | | | | | | | | | | | | | | | | | | | | | | | | | | | | | | | | | | | | | | | | | | | | | | | | | | | | | | | | | | | | | | | | | | | | |
| 1 | 3 | 5 | 7 | 9 | | | | | | | | | | | | | | | | | | | | | | | | | | | | | | | | | | | | | | | | | | | | | | | | | | | | | | | | | | | | | | | | | | | | | | | | | | | | | | | | | | | | | | | | | | | | | | | | | | | | | | | | | | | | | | | | | | | | | | | | | | | | | | | | | | | | | | | | | | | | | | | | | | | | | | | | | | | | | | | | | | | | | | | | | | | | | | | | | | | | | | | | | | | | | | | | | | | | | | | | | | | | | | | | | | | | | | | | | | | | | | | | | | | | | | | | | | | | | | | | | | | | | | | | | | | | | | | | | | | | | | | | | | | | | | | | | | | | | | | | | | | | | | | | | | | | | | | | | | | | | | | | | | | | | | | | | | | | | | | | | | | | | | | | | | | | | | | | | | | | | | | | | | | | | | | | | | | | | | | | | | | | | | | | | | | | | | | | | | | | | | | | | | | | | | | | | | | | | | | | | | | | | | | | | | | | | | | | | | | | | | | | | | | | | | | | | | | | | | | | | | | | | | | | | | | | | | | | | | | | | | | | | | | | | | | | | | | | | | | | | | | | | | | | | | | | | | | | | | | | | | | | | | | | | | | | | | | | | | | | | | | | | | | | | | | | | | | | | | | | | | | | | | | | | | | | | | | | | | | | | | | | | | | | | | | | | | |
| 1 | 0 | 0 | 0 | 0 | | | | | | | | | | | | | | | | | | | | | | | | | | | | | | | | | | | | | | | | | | | | | | | | | | | | | | | | | | | | | | | | | | | | | | | | | | | | | | | | | | | | | | | | | | | | | | | | | | | | | | | | | | | | | | | | | | | | | | | | | | | | | | | | | | | | | | | | | | | | | | | | | | | | | | | | | | | | | | | | | | | | | | | | | | | | | | | | | | | | | | | | | | | | | | | | | | | | | | | | | | | | | | | | | | | | | | | | | | | | | | | | | | | | | | | | | | | | | | | | | | | | | | | | | | | | | | | | | | | | | | | | | | | | | | | | | | | | | | | | | | | | | | | | | | | | | | | | | | | | | | | | | | | | | | | | | | | | | | | | | | | | | | | | | | | | | | | | | | | | | | | | | | | | | | | | | | | | | | | | | | | | | | | | | | | | | | | | | | | | | | | | | | | | | | | | | | | | | | | | | | | | | | | | | | | | | | | | | | | | | | | | | | | | | | | | | | | | | | | | | | | | | | | | | | | | | | | | | | | | | | | | | | | | | | | | | | | | | | | | | | | | | | | | | | | | | | | | | | | | | | | | | | | | | | | | | | | | | | | | | | | | | | | | | | | | | | | | | | | | | | | | | | | | | | | | | | | | | | | | | | | | | | | | | | | | | | |
| 3 | 0.2 | 0.3 | 0.4 | 0.6 | | | | | | | | | | | | | | | | | | | | | | | | | | | | | | | | | | | | | | | | | | | | | | | | | | | | | | | | | | | | | | | | | | | | | | | | | | | | | | | | | | | | | | | | | | | | | | | | | | | | | | | | | | | | | | | | | | | | | | | | | | | | | | | | | | | | | | | | | | | | | | | | | | | | | | | | | | | | | | | | | | | | | | | | | | | | | | | | | | | | | | | | | | | | | | | | | | | | | | | | | | | | | | | | | | | | | | | | | | | | | | | | | | | | | | | | | | | | | | | | | | | | | | | | | | | | | | | | | | | | | | | | | | | | | | | | | | | | | | | | | | | | | | | | | | | | | | | | | | | | | | | | | | | | | | | | | | | | | | | | | | | | | | | | | | | | | | | | | | | | | | | | | | | | | | | | | | | | | | | | | | | | | | | | | | | | | | | | | | | | | | | | | | | | | | | | | | | | | | | | | | | | | | | | | | | | | | | | | | | | | | | | | | | | | | | | | | | | | | | | | | | | | | | | | | | | | | | | | | | | | | | | | | | | | | | | | | | | | | | | | | | | | | | | | | | | | | | | | | | | | | | | | | | | | | | | | | | | | | | | | | | | | | | | | | | | | | | | | | | | | | | | | | | | | | | | | | | | | | | | | | | | | | | | | | | | | | |
| 5 | 0.5 | 0.7 | 0.9 | 1.3 | | | | | | | | | | | | | | | | | | | | | | | | | | | | | | | | | | | | | | | | | | | | | | | | | | | | | | | | | | | | | | | | | | | | | | | | | | | | | | | | | | | | | | | | | | | | | | | | | | | | | | | | | | | | | | | | | | | | | | | | | | | | | | | | | | | | | | | | | | | | | | | | | | | | | | | | | | | | | | | | | | | | | | | | | | | | | | | | | | | | | | | | | | | | | | | | | | | | | | | | | | | | | | | | | | | | | | | | | | | | | | | | | | | | | | | | | | | | | | | | | | | | | | | | | | | | | | | | | | | | | | | | | | | | | | | | | | | | | | | | | | | | | | | | | | | | | | | | | | | | | | | | | | | | | | | | | | | | | | | | | | | | | | | | | | | | | | | | | | | | | | | | | | | | | | | | | | | | | | | | | | | | | | | | | | | | | | | | | | | | | | | | | | | | | | | | | | | | | | | | | | | | | | | | | | | | | | | | | | | | | | | | | | | | | | | | | | | | | | | | | | | | | | | | | | | | | | | | | | | | | | | | | | | | | | | | | | | | | | | | | | | | | | | | | | | | | | | | | | | | | | | | | | | | | | | | | | | | | | | | | | | | | | | | | | | | | | | | | | | | | | | | | | | | | | | | | | | | | | | | | | | | | | | | | | | | | | |
| 7 | 0.9 | 1.2 | 1.5 | 2.1 | | | | | | | | | | | | | | | | | | | | | | | | | | | | | | | | | | | | | | | | | | | | | | | | | | | | | | | | | | | | | | | | | | | | | | | | | | | | | | | | | | | | | | | | | | | | | | | | | | | | | | | | | | | | | | | | | | | | | | | | | | | | | | | | | | | | | | | | | | | | | | | | | | | | | | | | | | | | | | | | | | | | | | | | | | | | | | | | | | | | | | | | | | | | | | | | | | | | | | | | | | | | | | | | | | | | | | | | | | | | | | | | | | | | | | | | | | | | | | | | | | | | | | | | | | | | | | | | | | | | | | | | | | | | | | | | | | | | | | | | | | | | | | | | | | | | | | | | | | | | | | | | | | | | | | | | | | | | | | | | | | | | | | | | | | | | | | | | | | | | | | | | | | | | | | | | | | | | | | | | | | | | | | | | | | | | | | | | | | | | | | | | | | | | | | | | | | | | | | | | | | | | | | | | | | | | | | | | | | | | | | | | | | | | | | | | | | | | | | | | | | | | | | | | | | | | | | | | | | | | | | | | | | | | | | | | | | | | | | | | | | | | | | | | | | | | | | | | | | | | | | | | | | | | | | | | | | | | | | | | | | | | | | | | | | | | | | | | | | | | | | | | | | | | | | | | | | | | | | | | | | | | | | | | | | | | | | |
| 9 | 1.4 | 1.8 | 2.2 | 3.0 | | | | | | | | | | | | | | | | | | | | | | | | | | | | | | | | | | | | | | | | | | | | | | | | | | | | | | | | | | | | | | | | | | | | | | | | | | | | | | | | | | | | | | | | | | | | | | | | | | | | | | | | | | | | | | | | | | | | | | | | | | | | | | | | | | | | | | | | | | | | | | | | | | | | | | | | | | | | | | | | | | | | | | | | | | | | | | | | | | | | | | | | | | | | | | | | | | | | | | | | | | | | | | | | | | | | | | | | | | | | | | | | | | | | | | | | | | | | | | | | | | | | | | | | | | | | | | | | | | | | | | | | | | | | | | | | | | | | | | | | | | | | | | | | | | | | | | | | | | | | | | | | | | | | | | | | | | | | | | | | | | | | | | | | | | | | | | | | | | | | | | | | | | | | | | | | | | | | | | | | | | | | | | | | | | | | | | | | | | | | | | | | | | | | | | | | | | | | | | | | | | | | | | | | | | | | | | | | | | | | | | | | | | | | | | | | | | | | | | | | | | | | | | | | | | | | | | | | | | | | | | | | | | | | | | | | | | | | | | | | | | | | | | | | | | | | | | | | | | | | | | | | | | | | | | | | | | | | | | | | | | | | | | | | | | | | | | | | | | | | | | | | | | | | | | | | | | | | | | | | | | | | | | | | | | | | | | |
| 1 | 3 | 5 | 7 | 9 | | | | | | | | | | | | | | | | | | | | | | | | | | | | | | | | | | | | | | | | | | | | | | | | | | | | | | | | | | | | | | | | | | | | | | | | | | | | | | | | | | | | | | | | | | | | | | | | | | | | | | | | | | | | | | | | | | | | | | | | | | | | | | | | | | | | | | | | | | | | | | | | | | | | | | | | | | | | | | | | | | | | | | | | | | | | | | | | | | | | | | | | | | | | | | | | | | | | | | | | | | | | | | | | | | | | | | | | | | | | | | | | | | | | | | | | | | | | | | | | | | | | | | | | | | | | | | | | | | | | | | | | | | | | | | | | | | | | | | | | | | | | | | | | | | | | | | | | | | | | | | | | | | | | | | | | | | | | | | | | | | | | | | | | | | | | | | | | | | | | | | | | | | | | | | | | | | | | | | | | | | | | | | | | | | | | | | | | | | | | | | | | | | | | | | | | | | | | | | | | | | | | | | | | | | | | | | | | | | | | | | | | | | | | | | | | | | | | | | | | | | | | | | | | | | | | | | | | | | | | | | | | | | | | | | | | | | | | | | | | | | | | | | | | | | | | | | | | | | | | | | | | | | | | | | | | | | | | | | | | | | | | | | | | | | | | | | | | | | | | | | | | | | | | | | | | | | | | | | | | | | | | | | | | | | | | | | |
| 1 | 0.5 | 0.9 | 1.3 | ... | | | | | | | | | | | | | | | | | | | | | | | | | | | | | | | | | | | | | | | | | | | | | | | | | | | | | | | | | | | | | | | | | | | | | | | | | | | | | | | | | | | | | | | | | | | | | | | | | | | | | | | | | | | | | | | | | | | | | | | | | | | | | | | | | | | | | | | | | | | | | | | | | | | | | | | | | | | | | | | | | | | | | | | | | | | | | | | | | | | | | | | | | | | | | | | | | | | | | | | | | | | | | | | | | | | | | | | | | | | | | | | | | | | | | | | | | | | | | | | | | | | | | | | | | | | | | | | | | | | | | | | | | | | | | | | | | | | | | | | | | | | | | | | | | | | | | | | | | | | | | | | | | | | | | | | | | | | | | | | | | | | | | | | | | | | | | | | | | | | | | | | | | | | | | | | | | | | | | | | | | | | | | | | | | | | | | | | | | | | | | | | | | | | | | | | | | | | | | | | | | | | | | | | | | | | | | | | | | | | | | | | | | | | | | | | | | | | | | | | | | | | | | | | | | | | | | | | | | | | | | | | | | | | | | | | | | | | | | | | | | | | | | | | | | | | | | | | | | | | | | | | | | | | | | | | | | | | | | | | | | | | | | | | | | | | | | | | | | | | | | | | | | | | | | | | | | | | | | | | | | | | | | | | | | | | | | | |
| 4 | ... | ... | ... | ... | | | | | | | | | | | | | | | | | | | | | | | | | | | | | | | | | | | | | | | | | | | | | | | | | | | | | | | | | | | | | | | | | | | | | | | | | | | | | | | | | | | | | | | | | | | | | | | | | | | | | | | | | | | | | | | | | | | | | | | | | | | | | | | | | | | | | | | | | | | | | | | | | | | | | | | | | | | | | | | | | | | | | | | | | | | | | | | | | | | | | | | | | | | | | | | | | | | | | | | | | | | | | | | | | | | | | | | | | | | | | | | | | | | | | | | | | | | | | | | | | | | | | | | | | | | | | | | | | | | | | | | | | | | | | | | | | | | | | | | | | | | | | | | | | | | | | | | | | | | | | | | | | | | | | | | | | | | | | | | | | | | | | | | | | | | | | | | | | | | | | | | | | | | | | | | | | | | | | | | | | | | | | | | | | | | | | | | | | | | | | | | | | | | | | | | | | | | | | | | | | | | | | | | | | | | | | | | | | | | | | | | | | | | | | | | | | | | | | | | | | | | | | | | | | | | | | | | | | | | | | | | | | | | | | | | | | | | | | | | | | | | | | | | | | | | | | | | | | | | | | | | | | | | | | | | | | | | | | | | | | | | | | | | | | | | | | | | | | | | | | | | | | | | | | | | | | | | | | | | | | | | | | | | | | | | | | | |
| 6 | ... | ... | ... | ... | | | | | | | | | | | | | | | | | | | | | | | | | | | | | | | | | | | | | | | | | | | | | | | | | | | | | | | | | | | | | | | | | | | | | | | | | | | | | | | | | | | | | | | | | | | | | | | | | | | | | | | | | | | | | | | | | | | | | | | | | | | | | | | | | | | | | | | | | | | | | | | | | | | | | | | | | | | | | | | | | | | | | | | | | | | | | | | | | | | | | | | | | | | | | | | | | | | | | | | | | | | | | | | | | | | | | | | | | | | | | | | | | | | | | | | | | | | | | | | | | | | | | | | | | | | | | | | | | | | | | | | | | | | | | | | | | | | | | | | | | | | | | | | | | | | | | | | | | | | | | | | | | | | | | | | | | | | | | | | | | | | | | | | | | | | | | | | | | | | | | | | | | | | | | | | | | | | | | | | | | | | | | | | | | | | | | | | | | | | | | | | | | | | | | | | | | | | | | | | | | | | | | | | | | | | | | | | | | | | | | | | | | | | | | | | | | | | | | | | | | | | | | | | | | | | | | | | | | | | | | | | | | | | | | | | | | | | | | | | | | | | | | | | | | | | | | | | | | | | | | | | | | | | | | | | | | | | | | | | | | | | | | | | | | | | | | | | | | | | | | | | | | | | | | | | | | | | | | | | | | | | | | | | | | | | | | | |
| 8 | ... | ... | ... | ... | | | | | | | | | | | | | | | | | | | | | | | | | | | | | | | | | | | | | | | | | | | | | | | | | | | | | | | | | | | | | | | | | | | | | | | | | | | | | | | | | | | | | | | | | | | | | | | | | | | | | | | | | | | | | | | | | | | | | | | | | | | | | | | | | | | | | | | | | | | | | | | | | | | | | | | | | | | | | | | | | | | | | | | | | | | | | | | | | | | | | | | | | | | | | | | | | | | | | | | | | | | | | | | | | | | | | | | | | | | | | | | | | | | | | | | | | | | | | | | | | | | | | | | | | | | | | | | | | | | | | | | | | | | | | | | | | | | | | | | | | | | | | | | | | | | | | | | | | | | | | | | | | | | | | | | | | | | | | | | | | | | | | | | | | | | | | | | | | | | | | | | | | | | | | | | | | | | | | | | | | | | | | | | | | | | | | | | | | | | | | | | | | | | | | | | | | | | | | | | | | | | | | | | | | | | | | | | | | | | | | | | | | | | | | | | | | | | | | | | | | | | | | | | | | | | | | | | | | | | | | | | | | | | | | | | | | | | | | | | | | | | | | | | | | | | | | | | | | | | | | | | | | | | | | | | | | | | | | | | | | | | | | | | | | | | | | | | | | | | | | | | | | | | | | | | | | | | | | | | | | | | | | | | | | | | | | | |
| 1 | 3 | 5 | 7 | 9 | | | | | | | | | | | | | | | | | | | | | | | | | | | | | | | | | | | | | | | | | | | | | | | | | | | | | | | | | | | | | | | | | | | | | | | | | | | | | | | | | | | | | | | | | | | | | | | | | | | | | | | | | | | | | | | | | | | | | | | | | | | | | | | | | | | | | | | | | | | | | | | | | | | | | | | | | | | | | | | | | | | | | | | | | | | | | | | | | | | | | | | | | | | | | | | | | | | | | | | | | | | | | | | | | | | | | | | | | | | | | | | | | | | | | | | | | | | | | | | | | | | | | | | | | | | | | | | | | | | | | | | | | | | | | | | | | | | | | | | | | | | | | | | | | | | | | | | | | | | | | | | | | | | | | | | | | | | | | | | | | | | | | | | | | | | | | | | | | | | | | | | | | | | | | | | | | | | | | | | | | | | | | | | | | | | | | | | | | | | | | | | | | | | | | | | | | | | | | | | | | | | | | | | | | | | | | | | | | | | | | | | | | | | | | | | | | | | | | | | | | | | | | | | | | | | | | | | | | | | | | | | | | | | | | | | | | | | | | | | | | | | | | | | | | | | | | | | | | | | | | | | | | | | | | | | | | | | | | | | | | | | | | | | | | | | | | | | | | | | | | | | | | | | | | | | | | | | | | | | | | | | | | | | | | | | | | | |
| 0.1 | 0.3 | 0.5 | 0.7 | 0.9 | | | | | | | | | | | | | | | | | | | | | | | | | | | | | | | | | | | | | | | | | | | | | | | | | | | | | | | | | | | | | | | | | | | | | | | | | | | | | | | | | | | | | | | | | | | | | | | | | | | | | | | | | | | | | | | | | | | | | | | | | | | | | | | | | | | | | | | | | | | | | | | | | | | | | | | | | | | | | | | | | | | | | | | | | | | | | | | | | | | | | | | | | | | | | | | | | | | | | | | | | | | | | | | | | | | | | | | | | | | | | | | | | | | | | | | | | | | | | | | | | | | | | | | | | | | | | | | | | | | | | | | | | | | | | | | | | | | | | | | | | | | | | | | | | | | | | | | | | | | | | | | | | | | | | | | | | | | | | | | | | | | | | | | | | | | | | | | | | | | | | | | | | | | | | | | | | | | | | | | | | | | | | | | | | | | | | | | | | | | | | | | | | | | | | | | | | | | | | | | | | | | | | | | | | | | | | | | | | | | | | | | | | | | | | | | | | | | | | | | | | | | | | | | | | | | | | | | | | | | | | | | | | | | | | | | | | | | | | | | | | | | | | | | | | | | | | | | | | | | | | | | | | | | | | | | | | | | | | | | | | | | | | | | | | | | | | | | | | | | | | | | | | | | | | | | | | | | | | | | | | | | | | | | | | | | | | | |
| 2 | 4 | 6 | 8 | 10 | | | | | | | | | | | | | | | | | | | | | | | | | | | | | | | | | | | | | | | | | | | | | | | | | | | | | | | | | | | | | | | | | | | | | | | | | | | | | | | | | | | | | | | | | | | | | | | | | | | | | | | | | | | | | | | | | | | | | | | | | | | | | | | | | | | | | | | | | | | | | | | | | | | | | | | | | | | | | | | | | | | | | | | | | | | | | | | | | | | | | | | | | | | | | | | | | | | | | | | | | | | | | | | | | | | | | | | | | | | | | | | | | | | | | | | | | | | | | | | | | | | | | | | | | | | | | | | | | | | | | | | | | | | | | | | | | | | | | | | | | | | | | | | | | | | | | | | | | | | | | | | | | | | | | | | | | | | | | | | | | | | | | | | | | | | | | | | | | | | | | | | | | | | | | | | | | | | | | | | | | | | | | | | | | | | | | | | | | | | | | | | | | | | | | | | | | | | | | | | | | | | | | | | | | | | | | | | | | | | | | | | | | | | | | | | | | | | | | | | | | | | | | | | | | | | | | | | | | | | | | | | | | | | | | | | | | | | | | | | | | | | | | | | | | | | | | | | | | | | | | | | | | | | | | | | | | | | | | | | | | | | | | | | | | | | | | | | | | | | | | | | | | | | | | | | | | | | | | | | | | | | | | | | | | | | | | | |
| 2.6 | 2.9 | 3.4 | 4.1 | 5.1 | | | | | | | | | | | | | | | | | | | | | | | | | | | | | | | | | | | | | | | | | | | | | | | | | | | | | | | | | | | | | | | | | | | | | | | | | | | | | | | | | | | | | | | | | | | | | | | | | | | | | | | | | | | | | | | | | | | | | | | | | | | | | | | | | | | | | | | | | | | | | | | | | | | | | | | | | | | | | | | | | | | | | | | | | | | | | | | | | | | | | | | | | | | | | | | | | | | | | | | | | | | | | | | | | | | | | | | | | | | | | | | | | | | | | | | | | | | | | | | | | | | | | | | | | | | | | | | | | | | | | | | | | | | | | | | | | | | | | | | | | | | | | | | | | | | | | | | | | | | | | | | | | | | | | | | | | | | | | | | | | | | | | | | | | | | | | | | | | | | | | | | | | | | | | | | | | | | | | | | | | | | | | | | | | | | | | | | | | | | | | | | | | | | | | | | | | | | | | | | | | | | | | | | | | | | | | | | | | | | | | | | | | | | | | | | | | | | | | | | | | | | | | | | | | | | | | | | | | | | | | | | | | | | | | | | | | | | | | | | | | | | | | | | | | | | | | | | | | | | | | | | | | | | | | | | | | | | | | | | | | | | | | | | | | | | | | | | | | | | | | | | | | | | | | | | | | | | | | | | | | | | | | | | | | | | | | | |
| 2 | 4 | 6 | 8 | 10 | | | | | | | | | | | | | | | | | | | | | | | | | | | | | | | | | | | | | | | | | | | | | | | | | | | | | | | | | | | | | | | | | | | | | | | | | | | | | | | | | | | | | | | | | | | | | | | | | | | | | | | | | | | | | | | | | | | | | | | | | | | | | | | | | | | | | | | | | | | | | | | | | | | | | | | | | | | | | | | | | | | | | | | | | | | | | | | | | | | | | | | | | | | | | | | | | | | | | | | | | | | | | | | | | | | | | | | | | | | | | | | | | | | | | | | | | | | | | | | | | | | | | | | | | | | | | | | | | | | | | | | | | | | | | | | | | | | | | | | | | | | | | | | | | | | | | | | | | | | | | | | | | | | | | | | | | | | | | | | | | | | | | | | | | | | | | | | | | | | | | | | | | | | | | | | | | | | | | | | | | | | | | | | | | | | | | | | | | | | | | | | | | | | | | | | | | | | | | | | | | | | | | | | | | | | | | | | | | | | | | | | | | | | | | | | | | | | | | | | | | | | | | | | | | | | | | | | | | | | | | | | | | | | | | | | | | | | | | | | | | | | | | | | | | | | | | | | | | | | | | | | | | | | | | | | | | | | | | | | | | | | | | | | | | | | | | | | | | | | | | | | | | | | | | | | | | | | | | | | | | | | | | | | | | | | | | | |
| 0.1 | 0.2 | 0.3 | 0.4 | 0.5 | | | | | | | | | | | | | | | | | | | | | | | | | | | | | | | | | | | | | | | | | | | | | | | | | | | | | | | | | | | | | | | | | | | | | | | | | | | | | | | | | | | | | | | | | | | | | | | | | | | | | | | | | | | | | | | | | | | | | | | | | | | | | | | | | | | | | | | | | | | | | | | | | | | | | | | | | | | | | | | | | | | | | | | | | | | | | | | | | | | | | | | | | | | | | | | | | | | | | | | | | | | | | | | | | | | | | | | | | | | | | | | | | | | | | | | | | | | | | | | | | | | | | | | | | | | | | | | | | | | | | | | | | | | | | | | | | | | | | | | | | | | | | | | | | | | | | | | | | | | | | | | | | | | | | | | | | | | | | | | | | | | | | | | | | | | | | | | | | | | | | | | | | | | | | | | | | | | | | | | | | | | | | | | | | | | | | | | | | | | | | | | | | | | | | | | | | | | | | | | | | | | | | | | | | | | | | | | | | | | | | | | | | | | | | | | | | | | | | | | | | | | | | | | | | | | | | | | | | | | | | | | | | | | | | | | | | | | | | | | | | | | | | | | | | | | | | | | | | | | | | | | | | | | | | | | | | | | | | | | | | | | | | | | | | | | | | | | | | | | | | | | | | | | | | | | | | | | | | | | | | | | | | | | | | | | | | | |
| 2 | 4 | 6 | 8 | 10 | | | | | | | | | | | | | | | | | | | | | | | | | | | | | | | | | | | | | | | | | | | | | | | | | | | | | | | | | | | | | | | | | | | | | | | | | | | | | | | | | | | | | | | | | | | | | | | | | | | | | | | | | | | | | | | | | | | | | | | | | | | | | | | | | | | | | | | | | | | | | | | | | | | | | | | | | | | | | | | | | | | | | | | | | | | | | | | | | | | | | | | | | | | | | | | | | | | | | | | | | | | | | | | | | | | | | | | | | | | | | | | | | | | | | | | | | | | | | | | | | | | | | | | | | | | | | | | | | | | | | | | | | | | | | | | | | | | | | | | | | | | | | | | | | | | | | | | | | | | | | | | | | | | | | | | | | | | | | | | | | | | | | | | | | | | | | | | | | | | | | | | | | | | | | | | | | | | | | | | | | | | | | | | | | | | | | | | | | | | | | | | | | | | | | | | | | | | | | | | | | | | | | | | | | | | | | | | | | | | | | | | | | | | | | | | | | | | | | | | | | | | | | | | | | | | | | | | | | | | | | | | | | | | | | | | | | | | | | | | | | | | | | | | | | | | | | | | | | | | | | | | | | | | | | | | | | | | | | | | | | | | | | | | | | | | | | | | | | | | | | | | | | | | | | | | | | | | | | | | | | | | | | | | | | | | | | | |
| 1 | 0 | 0 | 0 | 0 | | | | | | | | | | | | | | | | | | | | | | | | | | | | | | | | | | | | | | | | | | | | | | | | | | | | | | | | | | | | | | | | | | | | | | | | | | | | | | | | | | | | | | | | | | | | | | | | | | | | | | | | | | | | | | | | | | | | | | | | | | | | | | | | | | | | | | | | | | | | | | | | | | | | | | | | | | | | | | | | | | | | | | | | | | | | | | | | | | | | | | | | | | | | | | | | | | | | | | | | | | | | | | | | | | | | | | | | | | | | | | | | | | | | | | | | | | | | | | | | | | | | | | | | | | | | | | | | | | | | | | | | | | | | | | | | | | | | | | | | | | | | | | | | | | | | | | | | | | | | | | | | | | | | | | | | | | | | | | | | | | | | | | | | | | | | | | | | | | | | | | | | | | | | | | | | | | | | | | | | | | | | | | | | | | | | | | | | | | | | | | | | | | | | | | | | | | | | | | | | | | | | | | | | | | | | | | | | | | | | | | | | | | | | | | | | | | | | | | | | | | | | | | | | | | | | | | | | | | | | | | | | | | | | | | | | | | | | | | | | | | | | | | | | | | | | | | | | | | | | | | | | | | | | | | | | | | | | | | | | | | | | | | | | | | | | | | | | | | | | | | | | | | | | | | | | | | | | | | | | | | | | | | | | | | | | | | |
| 3 | 0.2 | 0.3 | 0.4 | 0.6 | | | | | | | | | | | | | | | | | | | | | | | | | | | | | | | | | | | | | | | | | | | | | | | | | | | | | | | | | | | | | | | | | | | | | | | | | | | | | | | | | | | | | | | | | | | | | | | | | | | | | | | | | | | | | | | | | | | | | | | | | | | | | | | | | | | | | | | | | | | | | | | | | | | | | | | | | | | | | | | | | | | | | | | | | | | | | | | | | | | | | | | | | | | | | | | | | | | | | | | | | | | | | | | | | | | | | | | | | | | | | | | | | | | | | | | | | | | | | | | | | | | | | | | | | | | | | | | | | | | | | | | | | | | | | | | | | | | | | | | | | | | | | | | | | | | | | | | | | | | | | | | | | | | | | | | | | | | | | | | | | | | | | | | | | | | | | | | | | | | | | | | | | | | | | | | | | | | | | | | | | | | | | | | | | | | | | | | | | | | | | | | | | | | | | | | | | | | | | | | | | | | | | | | | | | | | | | | | | | | | | | | | | | | | | | | | | | | | | | | | | | | | | | | | | | | | | | | | | | | | | | | | | | | | | | | | | | | | | | | | | | | | | | | | | | | | | | | | | | | | | | | | | | | | | | | | | | | | | | | | | | | | | | | | | | | | | | | | | | | | | | | | | | | | | | | | | | | | | | | | | | | | | | | | | | | | | | |
| 5 | 0.5 | 0.7 | 0.9 | 1.3 | | | | | | | | | | | | | | | | | | | | | | | | | | | | | | | | | | | | | | | | | | | | | | | | | | | | | | | | | | | | | | | | | | | | | | | | | | | | | | | | | | | | | | | | | | | | | | | | | | | | | | | | | | | | | | | | | | | | | | | | | | | | | | | | | | | | | | | | | | | | | | | | | | | | | | | | | | | | | | | | | | | | | | | | | | | | | | | | | | | | | | | | | | | | | | | | | | | | | | | | | | | | | | | | | | | | | | | | | | | | | | | | | | | | | | | | | | | | | | | | | | | | | | | | | | | | | | | | | | | | | | | | | | | | | | | | | | | | | | | | | | | | | | | | | | | | | | | | | | | | | | | | | | | | | | | | | | | | | | | | | | | | | | | | | | | | | | | | | | | | | | | | | | | | | | | | | | | | | | | | | | | | | | | | | | | | | | | | | | | | | | | | | | | | | | | | | | | | | | | | | | | | | | | | | | | | | | | | | | | | | | | | | | | | | | | | | | | | | | | | | | | | | | | | | | | | | | | | | | | | | | | | | | | | | | | | | | | | | | | | | | | | | | | | | | | | | | | | | | | | | | | | | | | | | | | | | | | | | | | | | | | | | | | | | | | | | | | | | | | | | | | | | | | | | | | | | | | | | | | | | | | | | | | | | | | | | | |
| 7 | 0.9 | 1.2 | 1.5 | 2.1 | | | | | | | | | | | | | | | | | | | | | | | | | | | | | | | | | | | | | | | | | | | | | | | | | | | | | | | | | | | | | | | | | | | | | | | | | | | | | | | | | | | | | | | | | | | | | | | | | | | | | | | | | | | | | | | | | | | | | | | | | | | | | | | | | | | | | | | | | | | | | | | | | | | | | | | | | | | | | | | | | | | | | | | | | | | | | | | | | | | | | | | | | | | | | | | | | | | | | | | | | | | | | | | | | | | | | | | | | | | | | | | | | | | | | | | | | | | | | | | | | | | | | | | | | | | | | | | | | | | | | | | | | | | | | | | | | | | | | | | | | | | | | | | | | | | | | | | | | | | | | | | | | | | | | | | | | | | | | | | | | | | | | | | | | | | | | | | | | | | | | | | | | | | | | | | | | | | | | | | | | | | | | | | | | | | | | | | | | | | | | | | | | | | | | | | | | | | | | | | | | | | | | | | | | | | | | | | | | | | | | | | | | | | | | | | | | | | | | | | | | | | | | | | | | | | | | | | | | | | | | | | | | | | | | | | | | | | | | | | | | | | | | | | | | | | | | | | | | | | | | | | | | | | | | | | | | | | | | | | | | | | | | | | | | | | | | | | | | | | | | | | | | | | | | | | | | | | | | | | | | | | | | | | | | | | | | | |
| 9 | 1.5 | 1.9 | 2.3 | 3.1 | | | | | | | | | | | | | | | | | | | | | | | | | | | | | | | | | | | | | | | | | | | | | | | | | | | | | | | | | | | | | | | | | | | | | | | | | | | | | | | | | | | | | | | | | | | | | | | | | | | | | | | | | | | | | | | | | | | | | | | | | | | | | | | | | | | | | | | | | | | | | | | | | | | | | | | | | | | | | | | | | | | | | | | | | | | | | | | | | | | | | | | | | | | | | | | | | | | | | | | | | | | | | | | | | | | | | | | | | | | | | | | | | | | | | | | | | | | | | | | | | | | | | | | | | | | | | | | | | | | | | | | | | | | | | | | | | | | | | | | | | | | | | | | | | | | | | | | | | | | | | | | | | | | | | | | | | | | | | | | | | | | | | | | | | | | | | | | | | | | | | | | | | | | | | | | | | | | | | | | | | | | | | | | | | | | | | | | | | | | | | | | | | | | | | | | | | | | | | | | | | | | | | | | | | | | | | | | | | | | | | | | | | | | | | | | | | | | | | | | | | | | | | | | | | | | | | | | | | | | | | | | | | | | | | | | | | | | | | | | | | | | | | | | | | | | | | | | | | | | | | | | | | | | | | | | | | | | | | | | | | | | | | | | | | | | | | | | | | | | | | | | | | | | | | | | | | | | | | | | | | | | | | | | | | | | | | | |
| 2 | 4 | 6 | 8 | 10 | | | | | | | | | | | | | | | | | | | | | | | | | | | | | | | | | | | | | | | | | | | | | | | | | | | | | | | | | | | | | | | | | | | | | | | | | | | | | | | | | | | | | | | | | | | | | | | | | | | | | | | | | | | | | | | | | | | | | | | | | | | | | | | | | | | | | | | | | | | | | | | | | | | | | | | | | | | | | | | | | | | | | | | | | | | | | | | | | | | | | | | | | | | | | | | | | | | | | | | | | | | | | | | | | | | | | | | | | | | | | | | | | | | | | | | | | | | | | | | | | | | | | | | | | | | | | | | | | | | | | | | | | | | | | | | | | | | | | | | | | | | | | | | | | | | | | | | | | | | | | | | | | | | | | | | | | | | | | | | | | | | | | | | | | | | | | | | | | | | | | | | | | | | | | | | | | | | | | | | | | | | | | | | | | | | | | | | | | | | | | | | | | | | | | | | | | | | | | | | | | | | | | | | | | | | | | | | | | | | | | | | | | | | | | | | | | | | | | | | | | | | | | | | | | | | | | | | | | | | | | | | | | | | | | | | | | | | | | | | | | | | | | | | | | | | | | | | | | | | | | | | | | | | | | | | | | | | | | | | | | | | | | | | | | | | | | | | | | | | | | | | | | | | | | | | | | | | | | | | | | | | | | | | | | | | | | | |
| 1 | 0.2 | 0.3 | 0.5 | 0.9 | | | | | | | | | | | | | | | | | | | | | | | | | | | | | | | | | | | | | | | | | | | | | | | | | | | | | | | | | | | | | | | | | | | | | | | | | | | | | | | | | | | | | | | | | | | | | | | | | | | | | | | | | | | | | | | | | | | | | | | | | | | | | | | | | | | | | | | | | | | | | | | | | | | | | | | | | | | | | | | | | | | | | | | | | | | | | | | | | | | | | | | | | | | | | | | | | | | | | | | | | | | | | | | | | | | | | | | | | | | | | | | | | | | | | | | | | | | | | | | | | | | | | | | | | | | | | | | | | | | | | | | | | | | | | | | | | | | | | | | | | | | | | | | | | | | | | | | | | | | | | | | | | | | | | | | | | | | | | | | | | | | | | | | | | | | | | | | | | | | | | | | | | | | | | | | | | | | | | | | | | | | | | | | | | | | | | | | | | | | | | | | | | | | | | | | | | | | | | | | | | | | | | | | | | | | | | | | | | | | | | | | | | | | | | | | | | | | | | | | | | | | | | | | | | | | | | | | | | | | | | | | | | | | | | | | | | | | | | | | | | | | | | | | | | | | | | | | | | | | | | | | | | | | | | | | | | | | | | | | | | | | | | | | | | | | | | | | | | | | | | | | | | | | | | | | | | | | | | | | | | | | | | | | | | | | | | | |
| 3 | 0.6 | 0.8 | 1.2 | ... | | | | | | | | | | | | | | | | | | | | | | | | | | | | | | | | | | | | | | | | | | | | | | | | | | | | | | | | | | | | | | | | | | | | | | | | | | | | | | | | | | | | | | | | | | | | | | | | | | | | | | | | | | | | | | | | | | | | | | | | | | | | | | | | | | | | | | | | | | | | | | | | | | | | | | | | | | | | | | | | | | | | | | | | | | | | | | | | | | | | | | | | | | | | | | | | | | | | | | | | | | | | | | | | | | | | | | | | | | | | | | | | | | | | | | | | | | | | | | | | | | | | | | | | | | | | | | | | | | | | | | | | | | | | | | | | | | | | | | | | | | | | | | | | | | | | | | | | | | | | | | | | | | | | | | | | | | | | | | | | | | | | | | | | | | | | | | | | | | | | | | | | | | | | | | | | | | | | | | | | | | | | | | | | | | | | | | | | | | | | | | | | | | | | | | | | | | | | | | | | | | | | | | | | | | | | | | | | | | | | | | | | | | | | | | | | | | | | | | | | | | | | | | | | | | | | | | | | | | | | | | | | | | | | | | | | | | | | | | | | | | | | | | | | | | | | | | | | | | | | | | | | | | | | | | | | | | | | | | | | | | | | | | | | | | | | | | | | | | | | | | | | | | | | | | | | | | | | | | | | | | | | | | | | | | | | | | |
| 5 | ... | ... | ... | ... | | | | | | | | | | | | | | | | | | | | | | | | | | | | | | | | | | | | | | | | | | | | | | | | | | | | | | | | | | | | | | | | | | | | | | | | | | | | | | | | | | | | | | | | | | | | | | | | | | | | | | | | | | | | | | | | | | | | | | | | | | | | | | | | | | | | | | | | | | | | | | | | | | | | | | | | | | | | | | | | | | | | | | | | | | | | | | | | | | | | | | | | | | | | | | | | | | | | | | | | | | | | | | | | | | | | | | | | | | | | | | | | | | | | | | | | | | | | | | | | | | | | | | | | | | | | | | | | | | | | | | | | | | | | | | | | | | | | | | | | | | | | | | | | | | | | | | | | | | | | | | | | | | | | | | | | | | | | | | | | | | | | | | | | | | | | | | | | | | | | | | | | | | | | | | | | | | | | | | | | | | | | | | | | | | | | | | | | | | | | | | | | | | | | | | | | | | | | | | | | | | | | | | | | | | | | | | | | | | | | | | | | | | | | | | | | | | | | | | | | | | | | | | | | | | | | | | | | | | | | | | | | | | | | | | | | | | | | | | | | | | | | | | | | | | | | | | | | | | | | | | | | | | | | | | | | | | | | | | | | | | | | | | | | | | | | | | | | | | | | | | | | | | | | | | | | | | | | | | | | | | | | | | | | | | | | | | |
| 7 | ... | ... | ... | ... | | | | | | | | | | | | | | | | | | | | | | | | | | | | | | | | | | | | | | | | | | | | | | | | | | | | | | | | | | | | | | | | | | | | | | | | | | | | | | | | | | | | | | | | | | | | | | | | | | | | | | | | | | | | | | | | | | | | | | | | | | | | | | | | | | | | | | | | | | | | | | | | | | | | | | | | | | | | | | | | | | | | | | | | | | | | | | | | | | | | | | | | | | | | | | | | | | | | | | | | | | | | | | | | | | | | | | | | | | | | | | | | | | | | | | | | | | | | | | | | | | | | | | | | | | | | | | | | | | | | | | | | | | | | | | | | | | | | | | | | | | | | | | | | | | | | | | | | | | | | | | | | | | | | | | | | | | | | | | | | | | | | | | | | | | | | | | | | | | | | | | | | | | | | | | | | | | | | | | | | | | | | | | | | | | | | | | | | | | | | | | | | | | | | | | | | | | | | | | | | | | | | | | | | | | | | | | | | | | | | | | | | | | | | | | | | | | | | | | | | | | | | | | | | | | | | | | | | | | | | | | | | | | | | | | | | | | | | | | | | | | | | | | | | | | | | | | | | | | | | | | | | | | | | | | | | | | | | | | | | | | | | | | | | | | | | | | | | | | | | | | | | | | | | | | | | | | | | | | | | | | | | | | | | | | | | | | |
| 9 | ... | ... | ... | ... | | | | | | | | | | | | | | | | | | | | | | | | | | | | | | | | | | | | | | | | | | | | | | | | | | | | | | | | | | | | | | | | | | | | | | | | | | | | | | | | | | | | | | | | | | | | | | | | | | | | | | | | | | | | | | | | | | | | | | | | | | | | | | | | | | | | | | | | | | | | | | | | | | | | | | | | | | | | | | | | | | | | | | | | | | | | | | | | | | | | | | | | | | | | | | | | | | | | | | | | | | | | | | | | | | | | | | | | | | | | | | | | | | | | | | | | | | | | | | | | | | | | | | | | | | | | | | | | | | | | | | | | | | | | | | | | | | | | | | | | | | | | | | | | | | | | | | | | | | | | | | | | | | | | | | | | | | | | | | | | | | | | | | | | | | | | | | | | | | | | | | | | | | | | | | | | | | | | | | | | | | | | | | | | | | | | | | | | | | | | | | | | | | | | | | | | | | | | | | | | | | | | | | | | | | | | | | | | | | | | | | | | | | | | | | | | | | | | | | | | | | | | | | | | | | | | | | | | | | | | | | | | | | | | | | | | | | | | | | | | | | | | | | | | | | | | | | | | | | | | | | | | | | | | | | | | | | | | | | | | | | | | | | | | | | | | | | | | | | | | | | | | | | | | | | | | | | | | | | | | | | | | | | | | | | | | | | |
| 2 | 4 | 6 | 8 | 10 | | | | | | | | | | | | | | | | | | | | | | | | | | | | | | | | | | | | | | | | | | | | | | | | | | | | | | | | | | | | | | | | | | | | | | | | | | | | | | | | | | | | | | | | | | | | | | | | | | | | | | | | | | | | | | | | | | | | | | | | | | | | | | | | | | | | | | | | | | | | | | | | | | | | | | | | | | | | | | | | | | | | | | | | | | | | | | | | | | | | | | | | | | | | | | | | | | | | | | | | | | | | | | | | | | | | | | | | | | | | | | | | | | | | | | | | | | | | | | | | | | | | | | | | | | | | | | | | | | | | | | | | | | | | | | | | | | | | | | | | | | | | | | | | | | | | | | | | | | | | | | | | | | | | | | | | | | | | | | | | | | | | | | | | | | | | | | | | | | | | | | | | | | | | | | | | | | | | | | | | | | | | | | | | | | | | | | | | | | | | | | | | | | | | | | | | | | | | | | | | | | | | | | | | | | | | | | | | | | | | | | | | | | | | | | | | | | | | | | | | | | | | | | | | | | | | | | | | | | | | | | | | | | | | | | | | | | | | | | | | | | | | | | | | | | | | | | | | | | | | | | | | | | | | | | | | | | | | | | | | | | | | | | | | | | | | | | | | | | | | | | | | | | | | | | | | | | | | | | | | | | | | | | | | | | | | | | |
| 0.0 | 0.0 | 0.1 | 0.1 | 0.2 | | | | | | | | | | | | | | | | | | | | | | | | | | | | | | | | | | | | | | | | | | | | | | | | | | | | | | | | | | | | | | | | | | | | | | | | | | | | | | | | | | | | | | | | | | | | | | | | | | | | | | | | | | | | | | | | | | | | | | | | | | | | | | | | | | | | | | | | | | | | | | | | | | | | | | | | | | | | | | | | | | | | | | | | | | | | | | | | | | | | | | | | | | | | | | | | | | | | | | | | | | | | | | | | | | | | | | | | | | | | | | | | | | | | | | | | | | | | | | | | | | | | | | | | | | | | | | | | | | | | | | | | | | | | | | | | | | | | | | | | | | | | | | | | | | | | | | | | | | | | | | | | | | | | | | | | | | | | | | | | | | | | | | | | | | | | | | | | | | | | | | | | | | | | | | | | | | | | | | | | | | | | | | | | | | | | | | | | | | | | | | | | | | | | | | | | | | | | | | | | | | | | | | | | | | | | | | | | | | | | | | | | | | | | | | | | | | | | | | | | | | | | | | | | | | | | | | | | | | | | | | | | | | | | | | | | | | | | | | | | | | | | | | | | | | | | | | | | | | | | | | | | | | | | | | | | | | | | | | | | | | | | | | | | | | | | | | | | | | | | | | | | | | | | | | | | | | | | | | | | | | | | | | | | | | | | | | |
| 2 | 4 | 6 | 8 | 10 | | | | | | | | | | | | | | | | | | | | | | | | | | | | | | | | | | | | | | | | | | | | | | | | | | | | | | | | | | | | | | | | | | | | | | | | | | | | | | | | | | | | | | | | | | | | | | | | | | | | | | | | | | | | | | | | | | | | | | | | | | | | | | | | | | | | | | | | | | | | | | | | | | | | | | | | | | | | | | | | | | | | | | | | | | | | | | | | | | | | | | | | | | | | | | | | | | | | | | | | | | | | | | | | | | | | | | | | | | | | | | | | | | | | | | | | | | | | | | | | | | | | | | | | | | | | | | | | | | | | | | | | | | | | | | | | | | | | | | | | | | | | | | | | | | | | | | | | | | | | | | | | | | | | | | | | | | | | | | | | | | | | | | | | | | | | | | | | | | | | | | | | | | | | | | | | | | | | | | | | | | | | | | | | | | | | | | | | | | | | | | | | | | | | | | | | | | | | | | | | | | | | | | | | | | | | | | | | | | | | | | | | | | | | | | | | | | | | | | | | | | | | | | | | | | | | | | | | | | | | | | | | | | | | | | | | | | | | | | | | | | | | | | | | | | | | | | | | | | | | | | | | | | | | | | | | | | | | | | | | | | | | | | | | | | | | | | | | | | | | | | | | | | | | | | | | | | | | | | | | | | | | | | | | | | | | | | |
| 2.6 | 2.9 | 3.4 | 4.1 | 5.1 | | | | | | | | | | | | | | | | | | | | | | | | | | | | | | | | | | | | | | | | | | | | | | | | | | | | | | | | | | | | | | | | | | | | | | | | | | | | | | | | | | | | | | | | | | | | | | | | | | | | | | | | | | | | | | | | | | | | | | | | | | | | | | | | | | | | | | | | | | | | | | | | | | | | | | | | | | | | | | | | | | | | | | | | | | | | | | | | | | | | | | | | | | | | | | | | | | | | | | | | | | | | | | | | | | | | | | | | | | | | | | | | | | | | | | | | | | | | | | | | | | | | | | | | | | | | | | | | | | | | | | | | | | | | | | | | | | | | | | | | | | | | | | | | | | | | | | | | | | | | | | | | | | | | | | | | | | | | | | | | | | | | | | | | | | | | | | | | | | | | | | | | | | | | | | | | | | | | | | | | | | | | | | | | | | | | | | | | | | | | | | | | | | | | | | | | | | | | | | | | | | | | | | | | | | | | | | | | | | | | | | | | | | | | | | | | | | | | | | | | | | | | | | | | | | | | | | | | | | | | | | | | | | | | | | | | | | | | | | | | | | | | | | | | | | | | | | | | | | | | | | | | | | | | | | | | | | | | | | | | | | | | | | | | | | | | | | | | | | | | | | | | | | | | | | | | | | | | | | | | | | | | | | | | | | | | | | |
| 2 | 4 | 6 | 8 | 10 | | | | | | | | | | | | | | | | | | | | | | | | | | | | | | | | | | | | | | | | | | | | | | | | | | | | | | | | | | | | | | | | | | | | | | | | | | | | | | | | | | | | | | | | | | | | | | | | | | | | | | | | | | | | | | | | | | | | | | | | | | | | | | | | | | | | | | | | | | | | | | | | | | | | | | | | | | | | | | | | | | | | | | | | | | | | | | | | | | | | | | | | | | | | | | | | | | | | | | | | | | | | | | | | | | | | | | | | | | | | | | | | | | | | | | | | | | | | | | | | | | | | | | | | | | | | | | | | | | | | | | | | | | | | | | | | | | | | | | | | | | | | | | | | | | | | | | | | | | | | | | | | | | | | | | | | | | | | | | | | | | | | | | | | | | | | | | | | | | | | | | | | | | | | | | | | | | | | | | | | | | | | | | | | | | | | | | | | | | | | | | | | | | | | | | | | | | | | | | | | | | | | | | | | | | | | | | | | | | | | | | | | | | | | | | | | | | | | | | | | | | | | | | | | | | | | | | | | | | | | | | | | | | | | | | | | | | | | | | | | | | | | | | | | | | | | | | | | | | | | | | | | | | | | | | | | | | | | | | | | | | | | | | | | | | | | | | | | | | | | | | | | | | | | | | | | | | | | | | | | | | | | | | | | | | | | | | |
| 0.1 | 0.2 | 0.4 | 0.6 | 0.8 | | | | | | | | | | | | | | | | | | | | | | | | | | | | | | | | | | | | | | | | | | | | | | | | | | | | | | | | | | | | | | | | | | | | | | | | | | | | | | | | | | | | | | | | | | | | | | | | | | | | | | | | | | | | | | | | | | | | | | | | | | | | | | | | | | | | | | | | | | | | | | | | | | | | | | | | | | | | | | | | | | | | | | | | | | | | | | | | | | | | | | | | | | | | | | | | | | | | | | | | | | | | | | | | | | | | | | | | | | | | | | | | | | | | | | | | | | | | | | | | | | | | | | | | | | | | | | | | | | | | | | | | | | | | | | | | | | | | | | | | | | | | | | | | | | | | | | | | | | | | | | | | | | | | | | | | | | | | | | | | | | | | | | | | | | | | | | | | | | | | | | | | | | | | | | | | | | | | | | | | | | | | | | | | | | | | | | | | | | | | | | | | | | | | | | | | | | | | | | | | | | | | | | | | | | | | | | | | | | | | | | | | | | | | | | | | | | | | | | | | | | | | | | | | | | | | | | | | | | | | | | | | | | | | | | | | | | | | | | | | | | | | | | | | | | | | | | | | | | | | | | | | | | | | | | | | | | | | | | | | | | | | | | | | | | | | | | | | | | | | | | | | | | | | | | | | | | | | | | | | | | | | | | | | | | | | | | |
| 2 | 4 | 6 | 8 | 10 | | | | | | | | | | | | | | | | | | | | | | | | | | | | | | | | | | | | | | | | | | | | | | | | | | | | | | | | | | | | | | | | | | | | | | | | | | | | | | | | | | | | | | | | | | | | | | | | | | | | | | | | | | | | | | | | | | | | | | | | | | | | | | | | | | | | | | | | | | | | | | | | | | | | | | | | | | | | | | | | | | | | | | | | | | | | | | | | | | | | | | | | | | | | | | | | | | | | | | | | | | | | | | | | | | | | | | | | | | | | | | | | | | | | | | | | | | | | | | | | | | | | | | | | | | | | | | | | | | | | | | | | | | | | | | | | | | | | | | | | | | | | | | | | | | | | | | | | | | | | | | | | | | | | | | | | | | | | | | | | | | | | | | | | | | | | | | | | | | | | | | | | | | | | | | | | | | | | | | | | | | | | | | | | | | | | | | | | | | | | | | | | | | | | | | | | | | | | | | | | | | | | | | | | | | | | | | | | | | | | | | | | | | | | | | | | | | | | | | | | | | | | | | | | | | | | | | | | | | | | | | | | | | | | | | | | | | | | | | | | | | | | | | | | | | | | | | | | | | | | | | | | | | | | | | | | | | | | | | | | | | | | | | | | | | | | | | | | | | | | | | | | | | | | | | | | | | | | | | | | | | | | | | | | | | | | | | |
| 1 | 0 | 0 | 0 | 0 | | | | | | | | | | | | | | | | | | | | | | | | | | | | | | | | | | | | | | | | | | | | | | | | | | | | | | | | | | | | | | | | | | | | | | | | | | | | | | | | | | | | | | | | | | | | | | | | | | | | | | | | | | | | | | | | | | | | | | | | | | | | | | | | | | | | | | | | | | | | | | | | | | | | | | | | | | | | | | | | | | | | | | | | | | | | | | | | | | | | | | | | | | | | | | | | | | | | | | | | | | | | | | | | | | | | | | | | | | | | | | | | | | | | | | | | | | | | | | | | | | | | | | | | | | | | | | | | | | | | | | | | | | | | | | | | | | | | | | | | | | | | | | | | | | | | | | | | | | | | | | | | | | | | | | | | | | | | | | | | | | | | | | | | | | | | | | | | | | | | | | | | | | | | | | | | | | | | | | | | | | | | | | | | | | | | | | | | | | | | | | | | | | | | | | | | | | | | | | | | | | | | | | | | | | | | | | | | | | | | | | | | | | | | | | | | | | | | | | | | | | | | | | | | | | | | | | | | | | | | | | | | | | | | | | | | | | | | | | | | | | | | | | | | | | | | | | | | | | | | | | | | | | | | | | | | | | | | | | | | | | | | | | | | | | | | | | | | | | | | | | | | | | | | | | | | | | | | | | | | | | | | | | | | | | | | | | |
| 3 | 0.3 | 0.4 | 0.5 | 0.7 | | | | | | | | | | | | | | | | | | | | | | | | | | | | | | | | | | | | | | | | | | | | | | | | | | | | | | | | | | | | | | | | | | | | | | | | | | | | | | | | | | | | | | | | | | | | | | | | | | | | | | | | | | | | | | | | | | | | | | | | | | | | | | | | | | | | | | | | | | | | | | | | | | | | | | | | | | | | | | | | | | | | | | | | | | | | | | | | | | | | | | | | | | | | | | | | | | | | | | | | | | | | | | | | | | | | | | | | | | | | | | | | | | | | | | | | | | | | | | | | | | | | | | | | | | | | | | | | | | | | | | | | | | | | | | | | | | | | | | | | | | | | | | | | | | | | | | | | | | | | | | | | | | | | | | | | | | | | | | | | | | | | | | | | | | | | | | | | | | | | | | | | | | | | | | | | | | | | | | | | | | | | | | | | | | | | | | | | | | | | | | | | | | | | | | | | | | | | | | | | | | | | | | | | | | | | | | | | | | | | | | | | | | | | | | | | | | | | | | | | | | | | | | | | | | | | | | | | | | | | | | | | | | | | | | | | | | | | | | | | | | | | | | | | | | | | | | | | | | | | | | | | | | | | | | | | | | | | | | | | | | | | | | | | | | | | | | | | | | | | | | | | | | | | | | | | | | | | | | | | | | | | | | | | | | | | | | |
| 5 | 0.7 | 0.9 | 1.1 | 1.5 | | | | | | | | | | | | | | | | | | | | | | | | | | | | | | | | | | | | | | | | | | | | | | | | | | | | | | | | | | | | | | | | | | | | | | | | | | | | | | | | | | | | | | | | | | | | | | | | | | | | | | | | | | | | | | | | | | | | | | | | | | | | | | | | | | | | | | | | | | | | | | | | | | | | | | | | | | | | | | | | | | | | | | | | | | | | | | | | | | | | | | | | | | | | | | | | | | | | | | | | | | | | | | | | | | | | | | | | | | | | | | | | | | | | | | | | | | | | | | | | | | | | | | | | | | | | | | | | | | | | | | | | | | | | | | | | | | | | | | | | | | | | | | | | | | | | | | | | | | | | | | | | | | | | | | | | | | | | | | | | | | | | | | | | | | | | | | | | | | | | | | | | | | | | | | | | | | | | | | | | | | | | | | | | | | | | | | | | | | | | | | | | | | | | | | | | | | | | | | | | | | | | | | | | | | | | | | | | | | | | | | | | | | | | | | | | | | | | | | | | | | | | | | | | | | | | | | | | | | | | | | | | | | | | | | | | | | | | | | | | | | | | | | | | | | | | | | | | | | | | | | | | | | | | | | | | | | | | | | | | | | | | | | | | | | | | | | | | | | | | | | | | | | | | | | | | | | | | | | | | | | | | | | | | | | | | | | |
| 7 | 1.2 | 1.5 | 1.8 | 2.4 | | | | | | | | | | | | | | | | | | | | | | | | | | | | | | | | | | | | | | | | | | | | | | | | | | | | | | | | | | | | | | | | | | | | | | | | | | | | | | | | | | | | | | | | | | | | | | | | | | | | | | | | | | | | | | | | | | | | | | | | | | | | | | | | | | | | | | | | | | | | | | | | | | | | | | | | | | | | | | | | | | | | | | | | | | | | | | | | | | | | | | | | | | | | | | | | | | | | | | | | | | | | | | | | | | | | | | | | | | | | | | | | | | | | | | | | | | | | | | | | | | | | | | | | | | | | | | | | | | | | | | | | | | | | | | | | | | | | | | | | | | | | | | | | | | | | | | | | | | | | | | | | | | | | | | | | | | | | | | | | | | | | | | | | | | | | | | | | | | | | | | | | | | | | | | | | | | | | | | | | | | | | | | | | | | | | | | | | | | | | | | | | | | | | | | | | | | | | | | | | | | | | | | | | | | | | | | | | | | | | | | | | | | | | | | | | | | | | | | | | | | | | | | | | | | | | | | | | | | | | | | | | | | | | | | | | | | | | | | | | | | | | | | | | | | | | | | | | | | | | | | | | | | | | | | | | | | | | | | | | | | | | | | | | | | | | | | | | | | | | | | | | | | | | | | | | | | | | | | | | | | | | | | | | | | | | | | |
| 9 | 1.9 | 2.3 | 2.7 | 3.3 | | | | | | | | | | | | | | | | | | | | | | | | | | | | | | | | | | | | | | | | | | | | | | | | | | | | | | | | | | | | | | | | | | | | | | | | | | | | | | | | | | | | | | | | | | | | | | | | | | | | | | | | | | | | | | | | | | | | | | | | | | | | | | | | | | | | | | | | | | | | | | | | | | | | | | | | | | | | | | | | | | | | | | | | | | | | | | | | | | | | | | | | | | | | | | | | | | | | | | | | | | | | | | | | | | | | | | | | | | | | | | | | | | | | | | | | | | | | | | | | | | | | | | | | | | | | | | | | | | | | | | | | | | | | | | | | | | | | | | | | | | | | | | | | | | | | | | | | | | | | | | | | | | | | | | | | | | | | | | | | | | | | | | | | | | | | | | | | | | | | | | | | | | | | | | | | | | | | | | | | | | | | | | | | | | | | | | | | | | | | | | | | | | | | | | | | | | | | | | | | | | | | | | | | | | | | | | | | | | | | | | | | | | | | | | | | | | | | | | | | | | | | | | | | | | | | | | | | | | | | | | | | | | | | | | | | | | | | | | | | | | | | | | | | | | | | | | | | | | | | | | | | | | | | | | | | | | | | | | | | | | | | | | | | | | | | | | | | | | | | | | | | | | | | | | | | | | | | | | | | | | | | | | | | | | | | | | |
| 10 | 2.5 | 3.1 | 3.9 | 4.7 | | | | | | | | | | | | | | | | | | | | | | | | | | | | | | | | | | | | | | | | | | | | | | | | | | | | | | | | | | | | | | | | | | | | | | | | | | | | | | | | | | | | | | | | | | | | | | | | | | | | | | | | | | | | | | | | | | | | | | | | | | | | | | | | | | | | | | | | | | | | | | | | | | | | | | | | | | | | | | | | | | | | | | | | | | | | | | | | | | | | | | | | | | | | | | | | | | | | | | | | | | | | | | | | | | | | | | | | | | | | | | | | | | | | | | | | | | | | | | | | | | | | | | | | | | | | | | | | | | | | | | | | | | | | | | | | | | | | | | | | | | | | | | | | | | | | | | | | | | | | | | | | | | | | | | | | | | | | | | | | | | | | | | | | | | | | | | | | | | | | | | | | | | | | | | | | | | | | | | | | | | | | | | | | | | | | | | | | | | | | | | | | | | | | | | | | | | | | | | | | | | | | | | | | | | | | | | | | | | | | | | | | | | | | | | | | | | | | | | | | | | | | | | | | | | | | | | | | | | | | | | | | | | | | | | | | | | | | | | | | | | | | | | | | | | | | | | | | | | | | | | | | | | | | | | | | | | | | | | | | | | | | | | | | | | | | | | | | | | | | | | | | | | | | | | | | | | | | | | | | | | | | | | | | | | | | | | |
| 2 | 4 | 6 | 8 | 10 | | | | | | | | | | | | | | | | | | | | | | | | | | | | | | | | | | | | | | | | | | | | | | | | | | | | | | | | | | | | | | | | | | | | | | | | | | | | | | | | | | | | | | | | | | | | | | | | | | | | | | | | | | | | | | | | | | | | | | | | | | | | | | | | | | | | | | | | | | | | | | | | | | | | | | | | | | | | | | | | | | | | | | | | | | | | | | | | | | | | | | | | | | | | | | | | | | | | | | | | | | | | | | | | | | | | | | | | | | | | | | | | | | | | | | | | | | | | | | | | | | | | | | | | | | | | | | | | | | | | | | | | | | | | | | | | | | | | | | | | | | | | | | | | | | | | | | | | | | | | | | | | | | | | | | | | | | | | | | | | | | | | | | | | | | | | | | | | | | | | | | | | | | | | | | | | | | | | | | | | | | | | | | | | | | | | | | | | | | | | | | | | | | | | | | | | | | | | | | | | | | | | | | | | | | | | | | | | | | | | | | | | | | | | | | | | | | | | | | | | | | | | | | | | | | | | | | | | | | | | | | | | | | | | | | | | | | | | | | | | | | | | | | | | | | | | | | | | | | | | | | | | | | | | | | | | | | | | | | | | | | | | | | | | | | | | | | | | | | | | | | | | | | | | | | | | | | | | | | | | | | | | | | | | | | | | | | |
| 1 | 0.2 | 0.3 | 0.5 | 0.7 | | | | | | | | | | | | | | | | | | | | | | | | | | | | | | | | | | | | | | | | | | | | | | | | | | | | | | | | | | | | | | | | | | | | | | | | | | | | | | | | | | | | | | | | | | | | | | | | | | | | | | | | | | | | | | | | | | | | | | | | | | | | | | | | | | | | | | | | | | | | | | | | | | | | | | | | | | | | | | | | | | | | | | | | | | | | | | | | | | | | | | | | | | | | | | | | | | | | | | | | | | | | | | | | | | | | | | | | | | | | | | | | | | | | | | | | | | | | | | | | | | | | | | | | | | | | | | | | | | | | | | | | | | | | | | | | | | | | | | | | | | | | | | | | | | | | | | | | | | | | | | | | | | | | | | | | | | | | | | | | | | | | | | | | | | | | | | | | | | | | | | | | | | | | | | | | | | | | | | | | | | | | | | | | | | | | | | | | | | | | | | | | | | | | | | | | | | | | | | | | | | | | | | | | | | | | | | | | | | | | | | | | | | | | | | | | | | | | | | | | | | | | | | | | | | | | | | | | | | | | | | | | | | | | | | | | | | | | | | | | | | | | | | | | | | | | | | | | | | | | | | | | | | | | | | | | | | | | | | | | | | | | | | | | | | | | | | | | | | | | | | | | | | | | | | | | | | | | | | | | | | | | | | | | | | | | | | |
| 3 | 0.7 | 0.9 | 1.1 | 1.5 | | | | | | | | | | | | | | | | | | | | | | | | | | | | | | | | | | | | | | | | | | | | | | | | | | | | | | | | | | | | | | | | | | | | | | | | | | | | | | | | | | | | | | | | | | | | | | | | | | | | | | | | | | | | | | | | | | | | | | | | | | | | | | | | | | | | | | | | | | | | | | | | | | | | | | | | | | | | | | | | | | | | | | | | | | | | | | | | | | | | | | | | | | | | | | | | | | | | | | | | | | | | | | | | | | | | | | | | | | | | | | | | | | | | | | | | | | | | | | | | | | | | | | | | | | | | | | | | | | | | | | | | | | | | | | | | | | | | | | | | | | | | | | | | | | | | | | | | | | | | | | | | | | | | | | | | | | | | | | | | | | | | | | | | | | | | | | | | | | | | | | | | | | | | | | | | | | | | | | | | | | | | | | | | | | | | | | | | | | | | | | | | | | | | | | | | | | | | | | | | | | | | | | | | | | | | | | | | | | | | | | | | | | | | | | | | | | | | | | | | | | | | | | | | | | | | | | | | | | | | | | | | | | | | | | | | | | | | | | | | | | | | | | | | | | | | | | | | | | | | | | | | | | | | | | | | | | | | | | | | | | | | | | | | | | | | | | | | | | | | | | | | | | | | | | | | | | | | | | | | | | | | | | | | | | | | | | |
| 5 | 1.3 | 1.5 | 1.8 | 2.5 | | | | | | | | | | | | | | | | | | | | | | | | | | | | | | | | | | | | | | | | | | | | | | | | | | | | | | | | | | | | | | | | | | | | | | | | | | | | | | | | | | | | | | | | | | | | | | | | | | | | | | | | | | | | | | | | | | | | | | | | | | | | | | | | | | | | | | | | | | | | | | | | | | | | | | | | | | | | | | | | | | | | | | | | | | | | | | | | | | | | | | | | | | | | | | | | | | | | | | | | | | | | | | | | | | | | | | | | | | | | | | | | | | | | | | | | | | | | | | | | | | | | | | | | | | | | | | | | | | | | | | | | | | | | | | | | | | | | | | | | | | | | | | | | | | | | | | | | | | | | | | | | | | | | | | | | | | | | | | | | | | | | | | | | | | | | | | | | | | | | | | | | | | | | | | | | | | | | | | | | | | | | | | | | | | | | | | | | | | | | | | | | | | | | | | | | | | | | | | | | | | | | | | | | | | | | | | | | | | | | | | | | | | | | | | | | | | | | | | | | | | | | | | | | | | | | | | | | | | | | | | | | | | | | | | | | | | | | | | | | | | | | | | | | | | | | | | | | | | | | | | | | | | | | | | | | | | | | | | | | | | | | | | | | | | | | | | | | | | | | | | | | | | | | | | | | | | | | | | | | | | | | | | | | | | | | | | |
| 7 | 2.0 | 2.3 | 2.7 | 3.6 | | | | | | | | | | | | | | | | | | | | | | | | | | | | | | | | | | | | | | | | | | | | | | | | | | | | | | | | | | | | | | | | | | | | | | | | | | | | | | | | | | | | | | | | | | | | | | | | | | | | | | | | | | | | | | | | | | | | | | | | | | | | | | | | | | | | | | | | | | | | | | | | | | | | | | | | | | | | | | | | | | | | | | | | | | | | | | | | | | | | | | | | | | | | | | | | | | | | | | | | | | | | | | | | | | | | | | | | | | | | | | | | | | | | | | | | | | | | | | | | | | | | | | | | | | | | | | | | | | | | | | | | | | | | | | | | | | | | | | | | | | | | | | | | | | | | | | | | | | | | | | | | | | | | | | | | | | | | | | | | | | | | | | | | | | | | | | | | | | | | | | | | | | | | | | | | | | | | | | | | | | | | | | | | | | | | | | | | | | | | | | | | | | | | | | | | | | | | | | | | | | | | | | | | | | | | | | | | | | | | | | | | | | | | | | | | | | | | | | | | | | | | | | | | | | | | | | | | | | | | | | | | | | | | | | | | | | | | | | | | | | | | | | | | | | | | | | | | | | | | | | | | | | | | | | | | | | | | | | | | | | | | | | | | | | | | | | | | | | | | | | | | | | | | | | | | | | | | | | | | | | | | | | | | | | | | | | |
| 9 | 2.9 | 3.5 | 4.3 | 5.6 | | | | | | | | | | | | | | | | | | | | | | | | | | | | | | | | | | | | | | | | | | | | | | | | | | | | | | | | | | | | | | | | | | | | | | | | | | | | | | | | | | | | | | | | | | | | | | | | | | | | | | | | | | | | | | | | | | | | | | | | | | | | | | | | | | | | | | | | | | | | | | | | | | | | | | | | | | | | | | | | | | | | | | | | | | | | | | | | | | | | | | | | | | | | | | | | | | | | | | | | | | | | | | | | | | | | | | | | | | | | | | | | | | | | | | | | | | | | | | | | | | | | | | | | | | | | | | | | | | | | | | | | | | | | | | | | | | | | | | | | | | | | | | | | | | | | | | | | | | | | | | | | | | | | | | | | | | | | | | | | | | | | | | | | | | | | | | | | | | | | | | | | | | | | | | | | | | | | | | | | | | | | | | | | | | | | | | | | | | | | | | | | | | | | | | | | | | | | | | | | | | | | | | | | | | | | | | | | | | | | | | | | | | | | | | | | | | | | | | | | | | | | | | | | | | | | | | | | | | | | | | | | | | | | | | | | | | | | | | | | | | | | | | | | | | | | | | | | | | | | | | | | | | | | | | | | | | | | | | | | | | | | | | | | | | | | | | | | | | | | | | | | | | | | | | | | | | | | | | | | | | | | | | | | | | | | | | |
| 2 | 4 | 6 | 8 | 10 | | | | | | | | | | | | | | | | | | | | | | | | | | | | | | | | | | | | | | | | | | | | | | | | | | | | | | | | | | | | | | | | | | | | | | | | | | | | | | | | | | | | | | | | | | | | | | | | | | | | | | | | | | | | | | | | | | | | | | | | | | | | | | | | | | | | | | | | | | | | | | | | | | | | | | | | | | | | | | | | | | | | | | | | | | | | | | | | | | | | | | | | | | | | | | | | | | | | | | | | | | | | | | | | | | | | | | | | | | | | | | | | | | | | | | | | | | | | | | | | | | | | | | | | | | | | | | | | | | | | | | | | | | | | | | | | | | | | | | | | | | | | | | | | | | | | | | | | | | | | | | | | | | | | | | | | | | | | | | | | | | | | | | | | | | | | | | | | | | | | | | | | | | | | | | | | | | | | | | | | | | | | | | | | | | | | | | | | | | | | | | | | | | | | | | | | | | | | | | | | | | | | | | | | | | | | | | | | | | | | | | | | | | | | | | | | | | | | | | | | | | | | | | | | | | | | | | | | | | | | | | | | | | | | | | | | | | | | | | | | | | | | | | | | | | | | | | | | | | | | | | | | | | | | | | | | | | | | | | | | | | | | | | | | | | | | | | | | | | | | | | | | | | | | | | | | | | | | | | | | | | | | | | | | | | | | | | |
| 0.0 | 0.0 | 0.1 | 0.1 | 0.2 | | | | | | | | | | | | | | | | | | | | | | | | | | | | | | | | | | | | | | | | | | | | | | | | | | | | | | | | | | | | | | | | | | | | | | | | | | | | | | | | | | | | | | | | | | | | | | | | | | | | | | | | | | | | | | | | | | | | | | | | | | | | | | | | | | | | | | | | | | | | | | | | | | | | | | | | | | | | | | | | | | | | | | | | | | | | | | | | | | | | | | | | | | | | | | | | | | | | | | | | | | | | | | | | | | | | | | | | | | | | | | | | | | | | | | | | | | | | | | | | | | | | | | | | | | | | | | | | | | | | | | | | | | | | | | | | | | | | | | | | | | | | | | | | | | | | | | | | | | | | | | | | | | | | | | | | | | | | | | | | | | | | | | | | | | | | | | | | | | | | | | | | | | | | | | | | | | | | | | | | | | | | | | | | | | | | | | | | | | | | | | | | | | | | | | | | | | | | | | | | | | | | | | | | | | | | | | | | | | | | | | | | | | | | | | | | | | | | | | | | | | | | | | | | | | | | | | | | | | | | | | | | | | | | | | | | | | | | | | | | | | | | | | | | | | | | | | | | | | | | | | | | | | | | | | | | | | | | | | | | | | | | | | | | | | | | | | | | | | | | | | | | | | | | | | | | | | | | | | | | | | | | | | | | | | | | | | |
| 1 | 3 | 5 | 7 | 9 | | | | | | | | | | | | | | | | | | | | | | | | | | | | | | | | | | | | | | | | | | | | | | | | | | | | | | | | | | | | | | | | | | | | | | | | | | | | | | | | | | | | | | | | | | | | | | | | | | | | | | | | | | | | | | | | | | | | | | | | | | | | | | | | | | | | | | | | | | | | | | | | | | | | | | | | | | | | | | | | | | | | | | | | | | | | | | | | | | | | | | | | | | | | | | | | | | | | | | | | | | | | | | | | | | | | | | | | | | | | | | | | | | | | | | | | | | | | | | | | | | | | | | | | | | | | | | | | | | | | | | | | | | | | | | | | | | | | | | | | | | | | | | | | | | | | | | | | | | | | | | | | | | | | | | | | | | | | | | | | | | | | | | | | | | | | | | | | | | | | | | | | | | | | | | | | | | | | | | | | | | | | | | | | | | | | | | | | | | | | | | | | | | | | | | | | | | | | | | | | | | | | | | | | | | | | | | | | | | | | | | | | | | | | | | | | | | | | | | | | | | | | | | | | | | | | | | | | | | | | | | | | | | | | | | | | | | | | | | | | | | | | | | | | | | | | | | | | | | | | | | | | | | | | | | | | | | | | | | | | | | | | | | | | | | | | | | | | | | | | | | | | | | | | | | | | | | | | | | | | | | | | | | | | | | | | | | |
| 2.6 | 2.9 | 3.4 | 4.1 | 5.1 | | | | | | | | | | | | | | | | | | | | | | | | | | | | | | | | | | | | | | | | | | | | | | | | | | | | | | | | | | | | | | | | | | | | | | | | | | | | | | | | | | | | | | | | | | | | | | | | | | | | | | | | | | | | | | | | | | | | | | | | | | | | | | | | | | | | | | | | | | | | | | | | | | | | | | | | | | | | | | | | | | | | | | | | | | | | | | | | | | | | | | | | | | | | | | | | | | | | | | | | | | | | | | | | | | | | | | | | | | | | | | | | | | | | | | | | | | | | | | | | | | | | | | | | | | | | | | | | | | | | | | | | | | | | | | | | | | | | | | | | | | | | | | | | | | | | | | | | | | | | | | | | | | | | | | | | | | | | | | | | | | | | | | | | | | | | | | | | | | | | | | | | | | | | | | | | | | | | | | | | | | | | | | | | | | | | | | | | | | | | | | | | | | | | | | | | | | | | | | | | | | | | | | | | | | | | | | | | | | | | | | | | | | | | | | | | | | | | | | | | | | | | | | | | | | | | | | | | | | | | | | | | | | | | | | | | | | | | | | | | | | | | | | | | | | | | | | | | | | | | | | | | | | | | | | | | | | | | | | | | | | | | | | | | | | | | | | | | | | | | | | | | | | | | | | | | | | | | | | | | | | | | | | | | | | | | | | |
| 1 | 3 | 5 | 7 | 9 | | | | | | | | | | | | | | | | | | | | | | | | | | | | | | | | | | | | | | | | | | | | | | | | | | | | | | | | | | | | | | | | | | | | | | | | | | | | | | | | | | | | | | | | | | | | | | | | | | | | | | | | | | | | | | | | | | | | | | | | | | | | | | | | | | | | | | | | | | | | | | | | | | | | | | | | | | | | | | | | | | | | | | | | | | | | | | | | | | | | | | | | | | | | | | | | | | | | | | | | | | | | | | | | | | | | | | | | | | | | | | | | | | | | | | | | | | | | | | | | | | | | | | | | | | | | | | | | | | | | | | | | | | | | | | | | | | | | | | | | | | | | | | | | | | | | | | | | | | | | | | | | | | | | | | | | | | | | | | | | | | | | | | | | | | | | | | | | | | | | | | | | | | | | | | | | | | | | | | | | | | | | | | | | | | | | | | | | | | | | | | | | | | | | | | | | | | | | | | | | | | | | | | | | | | | | | | | | | | | | | | | | | | | | | | | | | | | | | | | | | | | | | | | | | | | | | | | | | | | | | | | | | | | | | | | | | | | | | | | | | | | | | | | | | | | | | | | | | | | | | | | | | | | | | | | | | | | | | | | | | | | | | | | | | | | | | | | | | | | | | | | | | | | | | | | | | | | | | | | | | | | | | | | | | | | | | | |
| 0.0 | 0.1 | 0.2 | 0.4 | 0.6 | | | | | | | | | | | | | | | | | | | | | | | | | | | | | | | | | | | | | | | | | | | | | | | | | | | | | | | | | | | | | | | | | | | | | | | | | | | | | | | | | | | | | | | | | | | | | | | | | | | | | | | | | | | | | | | | | | | | | | | | | | | | | | | | | | | | | | | | | | | | | | | | | | | | | | | | | | | | | | | | | | | | | | | | | | | | | | | | | | | | | | | | | | | | | | | | | | | | | | | | | | | | | | | | | | | | | | | | | | | | | | | | | | | | | | | | | | | | | | | | | | | | | | | | | | | | | | | | | | | | | | | | | | | | | | | | | | | | | | | | | | | | | | | | | | | | | | | | | | | | | | | | | | | | | | | | | | | | | | | | | | | | | | | | | | | | | | | | | | | | | | | | | | | | | | | | | | | | | | | | | | | | | | | | | | | | | | | | | | | | | | | | | | | | | | | | | | | | | | | | | | | | | | | | | | | | | | | | | | | | | | | | | | | | | | | | | | | | | | | | | | | | | | | | | | | | | | | | | | | | | | | | | | | | | | | | | | | | | | | | | | | | | | | | | | | | | | | | | | | | | | | | | | | | | | | | | | | | | | | | | | | | | | | | | | | | | | | | | | | | | | | | | | | | | | | | | | | | | | | | | | | | | | | | | | | | | | |
| 1 | 3 | 5 | 7 | 9 | | | | | | | | | | | | | | | | | | | | | | | | | | | | | | | | | | | | | | | | | | | | | | | | | | | | | | | | | | | | | | | | | | | | | | | | | | | | | | | | | | | | | | | | | | | | | | | | | | | | | | | | | | | | | | | | | | | | | | | | | | | | | | | | | | | | | | | | | | | | | | | | | | | | | | | | | | | | | | | | | | | | | | | | | | | | | | | | | | | | | | | | | | | | | | | | | | | | | | | | | | | | | | | | | | | | | | | | | | | | | | | | | | | | | | | | | | | | | | | | | | | | | | | | | | | | | | | | | | | | | | | | | | | | | | | | | | | | | | | | | | | | | | | | | | | | | | | | | | | | | | | | | | | | | | | | | | | | | | | | | | | | | | | | | | | | | | | | | | | | | | | | | | | | | | | | | | | | | | | | | | | | | | | | | | | | | | | | | | | | | | | | | | | | | | | | | | | | | | | | | | | | | | | | | | | | | | | | | | | | | | | | | | | | | | | | | | | | | | | | | | | | | | | | | | | | | | | | | | | | | | | | | | | | | | | | | | | | | | | | | | | | | | | | | | | | | | | | | | | | | | | | | | | | | | | | | | | | | | | | | | | | | | | | | | | | | | | | | | | | | | | | | | | | | | | | | | | | | | | | | | | | | | | | | | | | | | |
| 1 | 0 | 0 | 0 | 0 | | | | | | | | | | | | | | | | | | | | | | | | | | | | | | | | | | | | | | | | | | | | | | | | | | | | | | | | | | | | | | | | | | | | | | | | | | | | | | | | | | | | | | | | | | | | | | | | | | | | | | | | | | | | | | | | | | | | | | | | | | | | | | | | | | | | | | | | | | | | | | | | | | | | | | | | | | | | | | | | | | | | | | | | | | | | | | | | | | | | | | | | | | | | | | | | | | | | | | | | | | | | | | | | | | | | | | | | | | | | | | | | | | | | | | | | | | | | | | | | | | | | | | | | | | | | | | | | | | | | | | | | | | | | | | | | | | | | | | | | | | | | | | | | | | | | | | | | | | | | | | | | | | | | | | | | | | | | | | | | | | | | | | | | | | | | | | | | | | | | | | | | | | | | | | | | | | | | | | | | | | | | | | | | | | | | | | | | | | | | | | | | | | | | | | | | | | | | | | | | | | | | | | | | | | | | | | | | | | | | | | | | | | | | | | | | | | | | | | | | | | | | | | | | | | | | | | | | | | | | | | | | | | | | | | | | | | | | | | | | | | | | | | | | | | | | | | | | | | | | | | | | | | | | | | | | | | | | | | | | | | | | | | | | | | | | | | | | | | | | | | | | | | | | | | | | | | | | | | | | | | | | | | | | | | | | | | |
| 3 | 0.3 | 0.4 | 0.5 | 0.7 | | | | | | | | | | | | | | | | | | | | | | | | | | | | | | | | | | | | | | | | | | | | | | | | | | | | | | | | | | | | | | | | | | | | | | | | | | | | | | | | | | | | | | | | | | | | | | | | | | | | | | | | | | | | | | | | | | | | | | | | | | | | | | | | | | | | | | | | | | | | | | | | | | | | | | | | | | | | | | | | | | | | | | | | | | | | | | | | | | | | | | | | | | | | | | | | | | | | | | | | | | | | | | | | | | | | | | | | | | | | | | | | | | | | | | | | | | | | | | | | | | | | | | | | | | | | | | | | | | | | | | | | | | | | | | | | | | | | | | | | | | | | | | | | | | | | | | | | | | | | | | | | | | | | | | | | | | | | | | | | | | | | | | | | | | | | | | | | | | | | | | | | | | | | | | | | | | | | | | | | | | | | | | | | | | | | | | | | | | | | | | | | | | | | | | | | | | | | | | | | | | | | | | | | | | | | | | | | | | | | | | | | | | | | | | | | | | | | | | | | | | | | | | | | | | | | | | | | | | | | | | | | | | | | | | | | | | | | | | | | | | | | | | | | | | | | | | | | | | | | | | | | | | | | | | | | | | | | | | | | | | | | | | | | | | | | | | | | | | | | | | | | | | | | | | | | | | | | | | | | | | | | | | | | | | | | | | |
| 5 | 0.7 | 0.9 | 1.1 | 1.5 | | | | | | | | | | | | | | | | | | | | | | | | | | | | | | | | | | | | | | | | | | | | | | | | | | | | | | | | | | | | | | | | | | | | | | | | | | | | | | | | | | | | | | | | | | | | | | | | | | | | | | | | | | | | | | | | | | | | | | | | | | | | | | | | | | | | | | | | | | | | | | | | | | | | | | | | | | | | | | | | | | | | | | | | | | | | | | | | | | | | | | | | | | | | | | | | | | | | | | | | | | | | | | | | | | | | | | | | | | | | | | | | | | | | | | | | | | | | | | | | | | | | | | | | | | | | | | | | | | | | | | | | | | | | | | | | | | | | | | | | | | | | | | | | | | | | | | | | | | | | | | | | | | | | | | | | | | | | | | | | | | | | | | | | | | | | | | | | | | | | | | | | | | | | | | | | | | | | | | | | | | | | | | | | | | | | | | | | | | | | | | | | | | | | | | | | | | | | | | | | | | | | | | | | | | | | | | | | | | | | | | | | | | | | | | | | | | | | | | | | | | | | | | | | | | | | | | | | | | | | | | | | | | | | | | | | | | | | | | | | | | | | | | | | | | | | | | | | | | | | | | | | | | | | | | | | | | | | | | | | | | | | | | | | | | | | | | | | | | | | | | | | | | | | | | | | | | | | | | | | | | | | | | | | | | | | | | |
| 7 | 1.2 | 1.5 | 1.8 | 2.4 | | | | | | | | | | | | | | | | | | | | | | | | | | | | | | | | | | | | | | | | | | | | | | | | | | | | | | | | | | | | | | | | | | | | | | | | | | | | | | | | | | | | | | | | | | | | | | | | | | | | | | | | | | | | | | | | | | | | | | | | | | | | | | | | | | | | | | | | | | | | | | | | | | | | | | | | | | | | | | | | | | | | | | | | | | | | | | | | | | | | | | | | | | | | | | | | | | | | | | | | | | | | | | | | | | | | | | | | | | | | | | | | | | | | | | | | | | | | | | | | | | | | | | | | | | | | | | | | | | | | | | | | | | | | | | | | | | | | | | | | | | | | | | | | | | | | | | | | | | | | | | | | | | | | | | | | | | | | | | | | | | | | | | | | | | | | | | | | | | | | | | | | | | | | | | | | | | | | | | | | | | | | | | | | | | | | | | | | | | | | | | | | | | | | | | | | | | | | | | | | | | | | | | | | | | | | | | | | | | | | | | | | | | | | | | | | | | | | | | | | | | | | | | | | | | | | | | | | | | | | | | | | | | | | | | | | | | | | | | | | | | | | | | | | | | | | | | | | | | | | | | | | | | | | | | | | | | | | | | | | | | | | | | | | | | | | | | | | | | | | | | | | | | | | | | | | | | | | | | | | | | | | | | | | | | | | | | |
| 9 | 1.8 | 2.2 | 2.6 | 3.4 | | | | | | | | | | | | | | | | | | | | | | | | | | | | | | | | | | | | | | | | | | | | | | | | | | | | | | | | | | | | | | | | | | | | | | | | | | | | | | | | | | | | | | | | | | | | | | | | | | | | | | | | | | | | | | | | | | | | | | | | | | | | | | | | | | | | | | | | | | | | | | | | | | | | | | | | | | | | | | | | | | | | | | | | | | | | | | | | | | | | | | | | | | | | | | | | | | | | | | | | | | | | | | | | | | | | | | | | | | | | | | | | | | | | | | | | | | | | | | | | | | | | | | | | | | | | | | | | | | | | | | | | | | | | | | | | | | | | | | | | | | | | | | | | | | | | | | | | | | | | | | | | | | | | | | | | | | | | | | | | | | | | | | | | | | | | | | | | | | | | | | | | | | | | | | | | | | | | | | | | | | | | | | | | | | | | | | | | | | | | | | | | | | | | | | | | | | | | | | | | | | | | | | | | | | | | | | | | | | | | | | | | | | | | | | | | | | | | | | | | | | | | | | | | | | | | | | | | | | | | | | | | | | | | | | | | | | | | | | | | | | | | | | | | | | | | | | | | | | | | | | | | | | | | | | | | | | | | | | | | | | | | | | | | | | | | | | | | | | | | | | | | | | | | | | | | | | | | | | | | | | | | | | | | | | | | | | |
| 10 | 2.2 | 2.6 | 3.4 | 4.2 | | | | | | | | | | | | | | | | | | | | | | | | | | | | | | | | | | | | | | | | | | | | | | | | | | | | | | | | | | | | | | | | | | | | | | | | | | | | | | | | | | | | | | | | | | | | | | | | | | | | | | | | | | | | | | | | | | | | | | | | | | | | | | | | | | | | | | | | | | | | | | | | | | | | | | | | | | | | | | | | | | | | | | | | | | | | | | | | | | | | | | | | | | | | | | | | | | | | | | | | | | | | | | | | | | | | | | | | | | | | | | | | | | | | | | | | | | | | | | | | | | | | | | | | | | | | | | | | | | | | | | | | | | | | | | | | | | | | | | | | | | | | | | | | | | | | | | | | | | | | | | | | | | | | | | | | | | | | | | | | | | | | | | | | | | | | | | | | | | | | | | | | | | | | | | | | | | | | | | | | | | | | | | | | | | | | | | | | | | | | | | | | | | | | | | | | | | | | | | | | | | | | | | | | | | | | | | | | | | | | | | | | | | | | | | | | | | | | | | | | | | | | | | | | | | | | | | | | | | | | | | | | | | | | | | | | | | | | | | | | | | | | | | | | | | | | | | | | | | | | | | | | | | | | | | | | | | | | | | | | | | | | | | | | | | | | | | | | | | | | | | | | | | | | | | | | | | | | | | | | | | | | | | | | | | | | | | |
| 1 | 3 | 5 | 7 | 9 | | | | | | | | | | | | | | | | | | | | | | | | | | | | | | | | | | | | | | | | | | | | | | | | | | | | | | | | | | | | | | | | | | | | | | | | | | | | | | | | | | | | | | | | | | | | | | | | | | | | | | | | | | | | | | | | | | | | | | | | | | | | | | | | | | | | | | | | | | | | | | | | | | | | | | | | | | | | | | | | | | | | | | | | | | | | | | | | | | | | | | | | | | | | | | | | | | | | | | | | | | | | | | | | | | | | | | | | | | | | | | | | | | | | | | | | | | | | | | | | | | | | | | | | | | | | | | | | | | | | | | | | | | | | | | | | | | | | | | | | | | | | | | | | | | | | | | | | | | | | | | | | | | | | | | | | | | | | | | | | | | | | | | | | | | | | | | | | | | | | | | | | | | | | | | | | | | | | | | | | | | | | | | | | | | | | | | | | | | | | | | | | | | | | | | | | | | | | | | | | | | | | | | | | | | | | | | | | | | | | | | | | | | | | | | | | | | | | | | | | | | | | | | | | | | | | | | | | | | | | | | | | | | | | | | | | | | | | | | | | | | | | | | | | | | | | | | | | | | | | | | | | | | | | | | | | | | | | | | | | | | | | | | | | | | | | | | | | | | | | | | | | | | | | | | | | | | | | | | | | | | | | | | | | | | | | | | |
| 1 | 0.2 | 0.3 | 0.5 | 0.7 | | | | | | | | | | | | | | | | | | | | | | | | | | | | | | | | | | | | | | | | | | | | | | | | | | | | | | | | | | | | | | | | | | | | | | | | | | | | | | | | | | | | | | | | | | | | | | | | | | | | | | | | | | | | | | | | | | | | | | | | | | | | | | | | | | | | | | | | | | | | | | | | | | | | | | | | | | | | | | | | | | | | | | | | | | | | | | | | | | | | | | | | | | | | | | | | | | | | | | | | | | | | | | | | | | | | | | | | | | | | | | | | | | | | | | | | | | | | | | | | | | | | | | | | | | | | | | | | | | | | | | | | | | | | | | | | | | | | | | | | | | | | | | | | | | | | | | | | | | | | | | | | | | | | | | | | | | | | | | | | | | | | | | | | | | | | | | | | | | | | | | | | | | | | | | | | | | | | | | | | | | | | | | | | | | | | | | | | | | | | | | | | | | | | | | | | | | | | | | | | | | | | | | | | | | | | | | | | | | | | | | | | | | | | | | | | | | | | | | | | | | | | | | | | | | | | | | | | | | | | | | | | | | | | | | | | | | | | | | | | | | | | | | | | | | | | | | | | | | | | | | | | | | | | | | | | | | | | | | | | | | | | | | | | | | | | | | | | | | | | | | | | | | | | | | | | | | | | | | | | | | | | | | | | | | | | | | |
| 3 | 0.7 | 0.9 | 1.1 | 1.5 | | | | | | | | | | | | | | | | | | | | | | | | | | | | | | | | | | | | | | | | | | | | | | | | | | | | | | | | | | | | | | | | | | | | | | | | | | | | | | | | | | | | | | | | | | | | | | | | | | | | | | | | | | | | | | | | | | | | | | | | | | | | | | | | | | | | | | | | | | | | | | | | | | | | | | | | | | | | | | | | | | | | | | | | | | | | | | | | | | | | | | | | | | | | | | | | | | | | | | | | | | | | | | | | | | | | | | | | | | | | | | | | | | | | | | | | | | | | | | | | | | | | | | | | | | | | | | | | | | | | | | | | | | | | | | | | | | | | | | | | | | | | | | | | | | | | | | | | | | | | | | | | | | | | | | | | | | | | | | | | | | | | | | | | | | | | | | | | | | | | | | | | | | | | | | | | | | | | | | | | | | | | | | | | | | | | | | | | | | | | | | | | | | | | | | | | | | | | | | | | | | | | | | | | | | | | | | | | | | | | | | | | | | | | | | | | | | | | | | | | | | | | | | | | | | | | | | | | | | | | | | | | | | | | | | | | | | | | | | | | | | | | | | | | | | | | | | | | | | | | | | | | | | | | | | | | | | | | | | | | | | | | | | | | | | | | | | | | | | | | | | | | | | | | | | | | | | | | | | | | | | | | | | | | | | | | | | |
| 5 | 1.3 | 1.5 | 1.8 | 2.3 | | | | | | | | | | | | | | | | | | | | | | | | | | | | | | | | | | | | | | | | | | | | | | | | | | | | | | | | | | | | | | | | | | | | | | | | | | | | | | | | | | | | | | | | | | | | | | | | | | | | | | | | | | | | | | | | | | | | | | | | | | | | | | | | | | | | | | | | | | | | | | | | | | | | | | | | | | | | | | | | | | | | | | | | | | | | | | | | | | | | | | | | | | | | | | | | | | | | | | | | | | | | | | | | | | | | | | | | | | | | | | | | | | | | | | | | | | | | | | | | | | | | | | | | | | | | | | | | | | | | | | | | | | | | | | | | | | | | | | | | | | | | | | | | | | | | | | | | | | | | | | | | | | | | | | | | | | | | | | | | | | | | | | | | | | | | | | | | | | | | | | | | | | | | | | | | | | | | | | | | | | | | | | | | | | | | | | | | | | | | | | | | | | | | | | | | | | | | | | | | | | | | | | | | | | | | | | | | | | | | | | | | | | | | | | | | | | | | | | | | | | | | | | | | | | | | | | | | | | | | | | | | | | | | | | | | | | | | | | | | | | | | | | | | | | | | | | | | | | | | | | | | | | | | | | | | | | | | | | | | | | | | | | | | | | | | | | | | | | | | | | | | | | | | | | | | | | | | | | | | | | | | | | | | | | | | | | |
| 7 | 2.0 | 2.3 | 2.7 | 3.3 | | | | | | | | | | | | | | | | | | | | | | | | | | | | | | | | | | | | | | | | | | | | | | | | | | | | | | | | | | | | | | | | | | | | | | | | | | | | | | | | | | | | | | | | | | | | | | | | | | | | | | | | | | | | | | | | | | | | | | | | | | | | | | | | | | | | | | | | | | | | | | | | | | | | | | | | | | | | | | | | | | | | | | | | | | | | | | | | | | | | | | | | | | | | | | | | | | | | | | | | | | | | | | | | | | | | | | | | | | | | | | | | | | | | | | | | | | | | | | | | | | | | | | | | | | | | | | | | | | | | | | | | | | | | | | | | | | | | | | | | | | | | | | | | | | | | | | | | | | | | | | | | | | | | | | | | | | | | | | | | | | | | | | | | | | | | | | | | | | | | | | | | | | | | | | | | | | | | | | | | | | | | | | | | | | | | | | | | | | | | | | | | | | | | | | | | | | | | | | | | | | | | | | | | | | | | | | | | | | | | | | | | | | | | | | | | | | | | | | | | | | | | | | | | | | | | | | | | | | | | | | | | | | | | | | | | | | | | | | | | | | | | | | | | | | | | | | | | | | | | | | | | | | | | | | | | | | | | | | | | | | | | | | | | | | | | | | | | | | | | | | | | | | | | | | | | | | | | | | | | | | | | | | | | | | | | | | |
| 9 | 2.8 | 3.4 | 4.2 | 5.3 | | | | | | | | | | | | | | | | | | | | | | | | | | | | | | | | | | | | | | | | | | | | | | | | | | | | | | | | | | | | | | | | | | | | | | | | | | | | | | | | | | | | | | | | | | | | | | | | | | | | | | | | | | | | | | | | | | | | | | | | | | | | | | | | | | | | | | | | | | | | | | | | | | | | | | | | | | | | | | | | | | | | | | | | | | | | | | | | | | | | | | | | | | | | | | | | | | | | | | | | | | | | | | | | | | | | | | | | | | | | | | | | | | | | | | | | | | | | | | | | | | | | | | | | | | | | | | | | | | | | | | | | | | | | | | | | | | | | | | | | | | | | | | | | | | | | | | | | | | | | | | | | | | | | | | | | | | | | | | | | | | | | | | | | | | | | | | | | | | | | | | | | | | | | | | | | | | | | | | | | | | | | | | | | | | | | | | | | | | | | | | | | | | | | | | | | | | | | | | | | | | | | | | | | | | | | | | | | | | | | | | | | | | | | | | | | | | | | | | | | | | | | | | | | | | | | | | | | | | | | | | | | | | | | | | | | | | | | | | | | | | | | | | | | | | | | | | | | | | | | | | | | | | | | | | | | | | | | | | | | | | | | | | | | | | | | | | | | | | | | | | | | | | | | | | | | | | | | | | | | | | | | | | | | | | | | | | |
| 1 | 3 | 5 | 7 | 9 | | | | | | | | | | | | | | | | | | | | | | | | | | | | | | | | | | | | | | | | | | | | | | | | | | | | | | | | | | | | | | | | | | | | | | | | | | | | | | | | | | | | | | | | | | | | | | | | | | | | | | | | | | | | | | | | | | | | | | | | | | | | | | | | | | | | | | | | | | | | | | | | | | | | | | | | | | | | | | | | | | | | | | | | | | | | | | | | | | | | | | | | | | | | | | | | | | | | | | | | | | | | | | | | | | | | | | | | | | | | | | | | | | | | | | | | | | | | | | | | | | | | | | | | | | | | | | | | | | | | | | | | | | | | | | | | | | | | | | | | | | | | | | | | | | | | | | | | | | | | | | | | | | | | | | | | | | | | | | | | | | | | | | | | | | | | | | | | | | | | | | | | | | | | | | | | | | | | | | | | | | | | | | | | | | | | | | | | | | | | | | | | | | | | | | | | | | | | | | | | | | | | | | | | | | | | | | | | | | | | | | | | | | | | | | | | | | | | | | | | | | | | | | | | | | | | | | | | | | | | | | | | | | | | | | | | | | | | | | | | | | | | | | | | | | | | | | | | | | | | | | | | | | | | | | | | | | | | | | | | | | | | | | | | | | | | | | | | | | | | | | | | | | | | | | | | | | | | | | | | | | | | | | | | | | | | | | |
| 0.0 | 0.1 | 0.2 | 0.3 | 0.4 | | | | | | | | | | | | | | | | | | | | | | | | | | | | | | | | | | | | | | | | | | | | | | | | | | | | | | | | | | | | | | | | | | | | | | | | | | | | | | | | | | | | | | | | | | | | | | | | | | | | | | | | | | | | | | | | | | | | | | | | | | | | | | | | | | | | | | | | | | | | | | | | | | | | | | | | | | | | | | | | | | | | | | | | | | | | | | | | | | | | | | | | | | | | | | | | | | | | | | | | | | | | | | | | | | | | | | | | | | | | | | | | | | | | | | | | | | | | | | | | | | | | | | | | | | | | | | | | | | | | | | | | | | | | | | | | | | | | | | | | | | | | | | | | | | | | | | | | | | | | | | | | | | | | | | | | | | | | | | | | | | | | | | | | | | | | | | | | | | | | | | | | | | | | | | | | | | | | | | | | | | | | | | | | | | | | | | | | | | | | | | | | | | | | | | | | | | | | | | | | | | | | | | | | | | | | | | | | | | | | | | | | | | | | | | | | | | | | | | | | | | | | | | | | | | | | | | | | | | | | | | | | | | | | | | | | | | | | | | | | | | | | | | | | | | | | | | | | | | | | | | | | | | | | | | | | | | | | | | | | | | | | | | | | | | | | | | | | | | | | | | | | | | | | | | | | | | | | | | | | | | | | | | | | | | | | | | |
| 1 | 3 | 5 | 7 | 9 | | | | | | | | | | | | | | | | | | | | | | | | | | | | | | | | | | | | | | | | | | | | | | | | | | | | | | | | | | | | | | | | | | | | | | | | | | | | | | | | | | | | | | | | | | | | | | | | | | | | | | | | | | | | | | | | | | | | | | | | | | | | | | | | | | | | | | | | | | | | | | | | | | | | | | | | | | | | | | | | | | | | | | | | | | | | | | | | | | | | | | | | | | | | | | | | | | | | | | | | | | | | | | | | | | | | | | | | | | | | | | | | | | | | | | | | | | | | | | | | | | | | | | | | | | | | | | | | | | | | | | | | | | | | | | | | | | | | | | | | | | | | | | | | | | | | | | | | | | | | | | | | | | | | | | | | | | | | | | | | | | | | | | | | | | | | | | | | | | | | | | | | | | | | | | | | | | | | | | | | | | | | | | | | | | | | | | | | | | | | | | | | | | | | | | | | | | | | | | | | | | | | | | | | | | | | | | | | | | | | | | | | | | | | | | | | | | | | | | | | | | | | | | | | | | | | | | | | | | | | | | | | | | | | | | | | | | | | | | | | | | | | | | | | | | | | | | | | | | | | | | | | | | | | | | | | | | | | | | | | | | | | | | | | | | | | | | | | | | | | | | | | | | | | | | | | | | | | | | | | | | | | | | | | | | | | | | |
| 2.6 | 2.9 | 3.4 | 4.1 | 5.1 | | | | | | | | | | | | | | | | | | | | | | | | | | | | | | | | | | | | | | | | | | | | | | | | | | | | | | | | | | | | | | | | | | | | | | | | | | | | | | | | | | | | | | | | | | | | | | | | | | | | | | | | | | | | | | | | | | | | | | | | | | | | | | | | | | | | | | | | | | | | | | | | | | | | | | | | | | | | | | | | | | | | | | | | | | | | | | | | | | | | | | | | | | | | | | | | | | | | | | | | | | | | | | | | | | | | | | | | | | | | | | | | | | | | | | | | | | | | | | | | | | | | | | | | | | | | | | | | | | | | | | | | | | | | | | | | | | | | | | | | | | | | | | | | | | | | | | | | | | | | | | | | | | | | | | | | | | | | | | | | | | | | | | | | | | | | | | | | | | | | | | | | | | | | | | | | | | | | | | | | | | | | | | | | | | | | | | | | | | | | | | | | | | | | | | | | | | | | | | | | | | | | | | | | | | | | | | | | | | | | | | | | | | | | | | | | | | | | | | | | | | | | | | | | | | | | | | | | | | | | | | | | | | | | | | | | | | | | | | | | | | | | | | | | | | | | | | | | | | | | | | | | | | | | | | | | | | | | | | | | | | | | | | | | | | | | | | | | | | | | | | | | | | | | | | | | | | | | | | | | | | | | | | | | | | | | | | |
| 1 | 3 | 5 | 7 | 9 | | | | | | | | | | | | | | | | | | | | | | | | | | | | | | | | | | | | | | | | | | | | | | | | | | | | | | | | | | | | | | | | | | | | | | | | | | | | | | | | | | | | | | | | | | | | | | | | | | | | | | | | | | | | | | | | | | | | | | | | | | | | | | | | | | | | | | | | | | | | | | | | | | | | | | | | | | | | | | | | | | | | | | | | | | | | | | | | | | | | | | | | | | | | | | | | | | | | | | | | | | | | | | | | | | | | | | | | | | | | | | | | | | | | | | | | | | | | | | | | | | | | | | | | | | | | | | | | | | | | | | | | | | | | | | | | | | | | | | | | | | | | | | | | | | | | | | | | | | | | | | | | | | | | | | | | | | | | | | | | | | | | | | | | | | | | | | | | | | | | | | | | | | | | | | | | | | | | | | | | | | | | | | | | | | | | | | | | | | | | | | | | | | | | | | | | | | | | | | | | | | | | | | | | | | | | | | | | | | | | | | | | | | | | | | | | | | | | | | | | | | | | | | | | | | | | | | | | | | | | | | | | | | | | | | | | | | | | | | | | | | | | | | | | | | | | | | | | | | | | | | | | | | | | | | | | | | | | | | | | | | | | | | | | | | | | | | | | | | | | | | | | | | | | | | | | | | | | | | | | | | | | | | | | | | | | | | |
| 0.1 | 0.3 | 0.5 | 0.7 | 0.9 | | | | | | | | | | | | | | | | | | | | | | | | | | | | | | | | | | | | | | | | | | | | | | | | | | | | | | | | | | | | | | | | | | | | | | | | | | | | | | | | | | | | | | | | | | | | | | | | | | | | | | | | | | | | | | | | | | | | | | | | | | | | | | | | | | | | | | | | | | | | | | | | | | | | | | | | | | | | | | | | | | | | | | | | | | | | | | | | | | | | | | | | | | | | | | | | | | | | | | | | | | | | | | | | | | | | | | | | | | | | | | | | | | | | | | | | | | | | | | | | | | | | | | | | | | | | | | | | | | | | | | | | | | | | | | | | | | | | | | | | | | | | | | | | | | | | | | | | | | | | | | | | | | | | | | | | | | | | | | | | | | | | | | | | | | | | | | | | | | | | | | | | | | | | | | | | | | | | | | | | | | | | | | | | | | | | | | | | | | | | | | | | | | | | | | | | | | | | | | | | | | | | | | | | | | | | | | | | | | | | | | | | | | | | | | | | | | | | | | | | | | | | | | | | | | | | | | | | | | | | | | | | | | | | | | | | | | | | | | | | | | | | | | | | | | | | | | | | | | | | | | | | | | | | | | | | | | | | | | | | | | | | | | | | | | | | | | | | | | | | | | | | | | | | | | | | | | | | | | | | | | | | | | | | | | | | | | |
| 1 | 3 | 5 | 7 | 9 | | | | | | | | | | | | | | | | | | | | | | | | | | | | | | | | | | | | | | | | | | | | | | | | | | | | | | | | | | | | | | | | | | | | | | | | | | | | | | | | | | | | | | | | | | | | | | | | | | | | | | | | | | | | | | | | | | | | | | | | | | | | | | | | | | | | | | | | | | | | | | | | | | | | | | | | | | | | | | | | | | | | | | | | | | | | | | | | | | | | | | | | | | | | | | | | | | | | | | | | | | | | | | | | | | | | | | | | | | | | | | | | | | | | | | | | | | | | | | | | | | | | | | | | | | | | | | | | | | | | | | | | | | | | | | | | | | | | | | | | | | | | | | | | | | | | | | | | | | | | | | | | | | | | | | | | | | | | | | | | | | | | | | | | | | | | | | | | | | | | | | | | | | | | | | | | | | | | | | | | | | | | | | | | | | | | | | | | | | | | | | | | | | | | | | | | | | | | | | | | | | | | | | | | | | | | | | | | | | | | | | | | | | | | | | | | | | | | | | | | | | | | | | | | | | | | | | | | | | | | | | | | | | | | | | | | | | | | | | | | | | | | | | | | | | | | | | | | | | | | | | | | | | | | | | | | | | | | | | | | | | | | | | | | | | | | | | | | | | | | | | | | | | | | | | | | | | | | | | | | | | | | | | | | | | | | | | |
| 0.0 | 0.1 | 0.2 | 0.3 | 0.4 | | | | | | | | | | | | | | | | | | | | | | | | | | | | | | | | | | | | | | | | | | | | | | | | | | | | | | | | | | | | | | | | | | | | | | | | | | | | | | | | | | | | | | | | | | | | | | | | | | | | | | | | | | | | | | | | | | | | | | | | | | | | | | | | | | | | | | | | | | | | | | | | | | | | | | | | | | | | | | | | | | | | | | | | | | | | | | | | | | | | | | | | | | | | | | | | | | | | | | | | | | | | | | | | | | | | | | | | | | | | | | | | | | | | | | | | | | | | | | | | | | | | | | | | | | | | | | | | | | | | | | | | | | | | | | | | | | | | | | | | | | | | | | | | | | | | | | | | | | | | | | | | | | | | | | | | | | | | | | | | | | | | | | | | | | | | | | | | | | | | | | | | | | | | | | | | | | | | | | | | | | | | | | | | | | | | | | | | | | | | | | | | | | | | | | | | | | | | | | | | | | | | | | | | | | | | | | | | | | | | | | | | | | | | | | | | | | | | | | | | | | | | | | | | | | | | | | | | | | | | | | | | | | | | | | | | | | | | | | | | | | | | | | | | | | | | | | | | | | | | | | | | | | | | | | | | | | | | | | | | | | | | | | | | | | | | | | | | | | | | | | | | | | | | | | | | | | | | | | | | | | | | | | | | | | | | | | |
| <p>POSITIONS VALUES FOR ALL GROUPS</p> <table border="1"> <tr><td>STAND. 1/2 SS</td><td>1</td><td>4</td><td>5</td><td>8</td><td>10</td><td>12</td></tr> <tr><td>ARM. 1/2 SS</td><td>2</td><td>3</td><td>5</td><td>7</td><td>9</td><td>11</td></tr> <tr><td>A</td><td>0.2</td><td>0.2</td><td>0.0</td><td>0.0</td><td>0.0</td><td>0.0</td></tr> <tr><td>B</td><td>0.0</td><td>0.0</td><td>0.0</td><td>0.0</td><td>0.0</td><td>0.0</td></tr> <tr><td>FMQB</td><td>0.1</td><td>0.1</td><td>0.1</td><td>0.1</td><td>0.4</td><td>0.4</td></tr> <tr><td>MQB</td><td>0.1</td><td>0.1</td><td>0.1</td><td>0.1</td><td>0.3</td><td>0.5</td></tr> <tr><td>FMQB C</td><td>-0.1</td><td>-0.2</td><td>-0.1</td><td>-0.1</td><td>-0.3</td><td>-0.5</td></tr> <tr><td>FMQB C</td><td>0.0</td><td>-0.1</td><td>-0.1</td><td>-0.1</td><td>-0.2</td><td>-</td></tr> <tr><td>MQB C</td><td>0.0</td><td>-</td><td>-</td><td>-</td><td>0.0</td><td>0.2</td></tr> <tr><td>D</td><td>0.0</td><td>0.0</td><td>0.0</td><td>0.0</td><td>0.0</td><td>0.0</td></tr> <tr><td>E</td><td>0.1</td><td>0.1</td><td>0.1</td><td>0.2</td><td>0.4</td><td>0.4</td></tr> </table> | | STAND. 1/2 SS | 1 | 4 | 5 | 8 | 10 | 12 | ARM. 1/2 SS | 2 | 3 | 5 | 7 | 9 | 11 | A | 0.2 | 0.2 | 0.0 | 0.0 | 0.0 | 0.0 | B | 0.0 | 0.0 | 0.0 | 0.0 | 0.0 | 0.0 | FMQB | 0.1 | 0.1 | 0.1 | 0.1 | 0.4 | 0.4 | MQB | 0.1 | 0.1 | 0.1 | 0.1 | 0.3 | 0.5 | FMQB C | -0.1 | -0.2 | -0.1 | -0.1 | -0.3 | -0.5 | FMQB C | 0.0 | -0.1 | -0.1 | -0.1 | -0.2 | - | MQB C | 0.0 | - | - | - | 0.0 | 0.2 | D | 0.0 | 0.0 | 0.0 | 0.0 | 0.0 | 0.0 | E | 0.1 | 0.1 | 0.1 | 0.2 | 0.4 | 0.4 | | | | | | | | | | | | | | | | | | | | | | | | | | | | | | | | | | | | | | | | | | | | | | | | | | | | | | | | | | | | | | | | | | | | | | | | | | | | | | | | | | | | | | | | | | | | | | | | | | | | | | | | | | | | | | | | | | | | | | | | | | | | | | | | | | | | | | | | | | | | | | | | | | | | | | | | | | | | | | | | | | | | | | | | | | | | | | | | | | | | | | | | | | | | | | | | | | | | | | | | | | | | | | | | | | | | | | | | | | | | | | | | | | | | | | | | | | | | | | | | | | | | | | | | | | | | | | | | | | | | | | | | | | | | | | | | | | | | | | | | | | | | | | | | | | | | | | | | | | | | | | | | | | | | | | | | | | | | | | | | | | | | | | | | | | | | | | | | | | | | | | | | | | | | | | | | | | | | | | | | | | | | | | | | | | | | | | | | | | | | | | | | | | | | | | | | | | | | | | | | | | | | | | | | | | | | | | | | | | | | | | | | | | | | | | | | | | | | | | | | | | | | | | | | | | | | | | | | | | | | | | | | | | | | | | | | | | | | | | | | | | | | | | | | | | | | | | | | | | | | |
| STAND. 1/2 SS | 1 | 4 | 5 | 8 | 10 | 12 | | | | | | | | | | | | | | | | | | | | | | | | | | | | | | | | | | | | | | | | | | | | | | | | | | | | | | | | | | | | | | | | | | | | | | | | | | | | | | | | | | | | | | | | | | | | | | | | | | | | | | | | | | | | | | | | | | | | | | | | | | | | | | | | | | | | | | | | | | | | | | | | | | | | | | | | | | | | | | | | | | | | | | | | | | | | | | | | | | | | | | | | | | | | | | | | | | | | | | | | | | | | | | | | | | | | | | | | | | | | | | | | | | | | | | | | | | | | | | | | | | | | | | | | | | | | | | | | | | | | | | | | | | | | | | | | | | | | | | | | | | | | | | | | | | | | | | | | | | | | | | | | | | | | | | | | | | | | | | | | | | | | | | | | | | | | | | | | | | | | | | | | | | | | | | | | | | | | | | | | | | | | | | | | | | | | | | | | | | | | | | | | | | | | | | | | | | | | | | | | | | | | | | | | | | | | | | | | | | | | | | | | | | | | | | | | | | | | | | | | | | | | | | | | | | | | | | | | | | | | | | | | | | | | | | | | | | | | | | | | | | | | | | | | | | | | | | | | | | | | | | | | | | | | | | | | | | | | | | | | | | | | | | | | | | | | | | | | | | | | | | | | | | | | | | | | | | | | | | | | | | | | | | | | | | | | |
| ARM. 1/2 SS | 2 | 3 | 5 | 7 | 9 | 11 | | | | | | | | | | | | | | | | | | | | | | | | | | | | | | | | | | | | | | | | | | | | | | | | | | | | | | | | | | | | | | | | | | | | | | | | | | | | | | | | | | | | | | | | | | | | | | | | | | | | | | | | | | | | | | | | | | | | | | | | | | | | | | | | | | | | | | | | | | | | | | | | | | | | | | | | | | | | | | | | | | | | | | | | | | | | | | | | | | | | | | | | | | | | | | | | | | | | | | | | | | | | | | | | | | | | | | | | | | | | | | | | | | | | | | | | | | | | | | | | | | | | | | | | | | | | | | | | | | | | | | | | | | | | | | | | | | | | | | | | | | | | | | | | | | | | | | | | | | | | | | | | | | | | | | | | | | | | | | | | | | | | | | | | | | | | | | | | | | | | | | | | | | | | | | | | | | | | | | | | | | | | | | | | | | | | | | | | | | | | | | | | | | | | | | | | | | | | | | | | | | | | | | | | | | | | | | | | | | | | | | | | | | | | | | | | | | | | | | | | | | | | | | | | | | | | | | | | | | | | | | | | | | | | | | | | | | | | | | | | | | | | | | | | | | | | | | | | | | | | | | | | | | | | | | | | | | | | | | | | | | | | | | | | | | | | | | | | | | | | | | | | | | | | | | | | | | | | | | | | | | | | | | | | | | | | |
| A | 0.2 | 0.2 | 0.0 | 0.0 | 0.0 | 0.0 | | | | | | | | | | | | | | | | | | | | | | | | | | | | | | | | | | | | | | | | | | | | | | | | | | | | | | | | | | | | | | | | | | | | | | | | | | | | | | | | | | | | | | | | | | | | | | | | | | | | | | | | | | | | | | | | | | | | | | | | | | | | | | | | | | | | | | | | | | | | | | | | | | | | | | | | | | | | | | | | | | | | | | | | | | | | | | | | | | | | | | | | | | | | | | | | | | | | | | | | | | | | | | | | | | | | | | | | | | | | | | | | | | | | | | | | | | | | | | | | | | | | | | | | | | | | | | | | | | | | | | | | | | | | | | | | | | | | | | | | | | | | | | | | | | | | | | | | | | | | | | | | | | | | | | | | | | | | | | | | | | | | | | | | | | | | | | | | | | | | | | | | | | | | | | | | | | | | | | | | | | | | | | | | | | | | | | | | | | | | | | | | | | | | | | | | | | | | | | | | | | | | | | | | | | | | | | | | | | | | | | | | | | | | | | | | | | | | | | | | | | | | | | | | | | | | | | | | | | | | | | | | | | | | | | | | | | | | | | | | | | | | | | | | | | | | | | | | | | | | | | | | | | | | | | | | | | | | | | | | | | | | | | | | | | | | | | | | | | | | | | | | | | | | | | | | | | | | | | | | | | | | | | | | | | | | |
| B | 0.0 | 0.0 | 0.0 | 0.0 | 0.0 | 0.0 | | | | | | | | | | | | | | | | | | | | | | | | | | | | | | | | | | | | | | | | | | | | | | | | | | | | | | | | | | | | | | | | | | | | | | | | | | | | | | | | | | | | | | | | | | | | | | | | | | | | | | | | | | | | | | | | | | | | | | | | | | | | | | | | | | | | | | | | | | | | | | | | | | | | | | | | | | | | | | | | | | | | | | | | | | | | | | | | | | | | | | | | | | | | | | | | | | | | | | | | | | | | | | | | | | | | | | | | | | | | | | | | | | | | | | | | | | | | | | | | | | | | | | | | | | | | | | | | | | | | | | | | | | | | | | | | | | | | | | | | | | | | | | | | | | | | | | | | | | | | | | | | | | | | | | | | | | | | | | | | | | | | | | | | | | | | | | | | | | | | | | | | | | | | | | | | | | | | | | | | | | | | | | | | | | | | | | | | | | | | | | | | | | | | | | | | | | | | | | | | | | | | | | | | | | | | | | | | | | | | | | | | | | | | | | | | | | | | | | | | | | | | | | | | | | | | | | | | | | | | | | | | | | | | | | | | | | | | | | | | | | | | | | | | | | | | | | | | | | | | | | | | | | | | | | | | | | | | | | | | | | | | | | | | | | | | | | | | | | | | | | | | | | | | | | | | | | | | | | | | | | | | | | | | | | | | |
| FMQB | 0.1 | 0.1 | 0.1 | 0.1 | 0.4 | 0.4 | | | | | | | | | | | | | | | | | | | | | | | | | | | | | | | | | | | | | | | | | | | | | | | | | | | | | | | | | | | | | | | | | | | | | | | | | | | | | | | | | | | | | | | | | | | | | | | | | | | | | | | | | | | | | | | | | | | | | | | | | | | | | | | | | | | | | | | | | | | | | | | | | | | | | | | | | | | | | | | | | | | | | | | | | | | | | | | | | | | | | | | | | | | | | | | | | | | | | | | | | | | | | | | | | | | | | | | | | | | | | | | | | | | | | | | | | | | | | | | | | | | | | | | | | | | | | | | | | | | | | | | | | | | | | | | | | | | | | | | | | | | | | | | | | | | | | | | | | | | | | | | | | | | | | | | | | | | | | | | | | | | | | | | | | | | | | | | | | | | | | | | | | | | | | | | | | | | | | | | | | | | | | | | | | | | | | | | | | | | | | | | | | | | | | | | | | | | | | | | | | | | | | | | | | | | | | | | | | | | | | | | | | | | | | | | | | | | | | | | | | | | | | | | | | | | | | | | | | | | | | | | | | | | | | | | | | | | | | | | | | | | | | | | | | | | | | | | | | | | | | | | | | | | | | | | | | | | | | | | | | | | | | | | | | | | | | | | | | | | | | | | | | | | | | | | | | | | | | | | | | | | | | | | | | | | | |
| MQB | 0.1 | 0.1 | 0.1 | 0.1 | 0.3 | 0.5 | | | | | | | | | | | | | | | | | | | | | | | | | | | | | | | | | | | | | | | | | | | | | | | | | | | | | | | | | | | | | | | | | | | | | | | | | | | | | | | | | | | | | | | | | | | | | | | | | | | | | | | | | | | | | | | | | | | | | | | | | | | | | | | | | | | | | | | | | | | | | | | | | | | | | | | | | | | | | | | | | | | | | | | | | | | | | | | | | | | | | | | | | | | | | | | | | | | | | | | | | | | | | | | | | | | | | | | | | | | | | | | | | | | | | | | | | | | | | | | | | | | | | | | | | | | | | | | | | | | | | | | | | | | | | | | | | | | | | | | | | | | | | | | | | | | | | | | | | | | | | | | | | | | | | | | | | | | | | | | | | | | | | | | | | | | | | | | | | | | | | | | | | | | | | | | | | | | | | | | | | | | | | | | | | | | | | | | | | | | | | | | | | | | | | | | | | | | | | | | | | | | | | | | | | | | | | | | | | | | | | | | | | | | | | | | | | | | | | | | | | | | | | | | | | | | | | | | | | | | | | | | | | | | | | | | | | | | | | | | | | | | | | | | | | | | | | | | | | | | | | | | | | | | | | | | | | | | | | | | | | | | | | | | | | | | | | | | | | | | | | | | | | | | | | | | | | | | | | | | | | | | | | | | | | | | | |
| FMQB C | -0.1 | -0.2 | -0.1 | -0.1 | -0.3 | -0.5 | | | | | | | | | | | | | | | | | | | | | | | | | | | | | | | | | | | | | | | | | | | | | | | | | | | | | | | | | | | | | | | | | | | | | | | | | | | | | | | | | | | | | | | | | | | | | | | | | | | | | | | | | | | | | | | | | | | | | | | | | | | | | | | | | | | | | | | | | | | | | | | | | | | | | | | | | | | | | | | | | | | | | | | | | | | | | | | | | | | | | | | | | | | | | | | | | | | | | | | | | | | | | | | | | | | | | | | | | | | | | | | | | | | | | | | | | | | | | | | | | | | | | | | | | | | | | | | | | | | | | | | | | | | | | | | | | | | | | | | | | | | | | | | | | | | | | | | | | | | | | | | | | | | | | | | | | | | | | | | | | | | | | | | | | | | | | | | | | | | | | | | | | | | | | | | | | | | | | | | | | | | | | | | | | | | | | | | | | | | | | | | | | | | | | | | | | | | | | | | | | | | | | | | | | | | | | | | | | | | | | | | | | | | | | | | | | | | | | | | | | | | | | | | | | | | | | | | | | | | | | | | | | | | | | | | | | | | | | | | | | | | | | | | | | | | | | | | | | | | | | | | | | | | | | | | | | | | | | | | | | | | | | | | | | | | | | | | | | | | | | | | | | | | | | | | | | | | | | | | | | | | | | | | | | | | | |
| FMQB C | 0.0 | -0.1 | -0.1 | -0.1 | -0.2 | - | | | | | | | | | | | | | | | | | | | | | | | | | | | | | | | | | | | | | | | | | | | | | | | | | | | | | | | | | | | | | | | | | | | | | | | | | | | | | | | | | | | | | | | | | | | | | | | | | | | | | | | | | | | | | | | | | | | | | | | | | | | | | | | | | | | | | | | | | | | | | | | | | | | | | | | | | | | | | | | | | | | | | | | | | | | | | | | | | | | | | | | | | | | | | | | | | | | | | | | | | | | | | | | | | | | | | | | | | | | | | | | | | | | | | | | | | | | | | | | | | | | | | | | | | | | | | | | | | | | | | | | | | | | | | | | | | | | | | | | | | | | | | | | | | | | | | | | | | | | | | | | | | | | | | | | | | | | | | | | | | | | | | | | | | | | | | | | | | | | | | | | | | | | | | | | | | | | | | | | | | | | | | | | | | | | | | | | | | | | | | | | | | | | | | | | | | | | | | | | | | | | | | | | | | | | | | | | | | | | | | | | | | | | | | | | | | | | | | | | | | | | | | | | | | | | | | | | | | | | | | | | | | | | | | | | | | | | | | | | | | | | | | | | | | | | | | | | | | | | | | | | | | | | | | | | | | | | | | | | | | | | | | | | | | | | | | | | | | | | | | | | | | | | | | | | | | | | | | | | | | | | | | | | | | | | | |
| MQB C | 0.0 | - | - | - | 0.0 | 0.2 | | | | | | | | | | | | | | | | | | | | | | | | | | | | | | | | | | | | | | | | | | | | | | | | | | | | | | | | | | | | | | | | | | | | | | | | | | | | | | | | | | | | | | | | | | | | | | | | | | | | | | | | | | | | | | | | | | | | | | | | | | | | | | | | | | | | | | | | | | | | | | | | | | | | | | | | | | | | | | | | | | | | | | | | | | | | | | | | | | | | | | | | | | | | | | | | | | | | | | | | | | | | | | | | | | | | | | | | | | | | | | | | | | | | | | | | | | | | | | | | | | | | | | | | | | | | | | | | | | | | | | | | | | | | | | | | | | | | | | | | | | | | | | | | | | | | | | | | | | | | | | | | | | | | | | | | | | | | | | | | | | | | | | | | | | | | | | | | | | | | | | | | | | | | | | | | | | | | | | | | | | | | | | | | | | | | | | | | | | | | | | | | | | | | | | | | | | | | | | | | | | | | | | | | | | | | | | | | | | | | | | | | | | | | | | | | | | | | | | | | | | | | | | | | | | | | | | | | | | | | | | | | | | | | | | | | | | | | | | | | | | | | | | | | | | | | | | | | | | | | | | | | | | | | | | | | | | | | | | | | | | | | | | | | | | | | | | | | | | | | | | | | | | | | | | | | | | | | | | | | | | | | | | | | | | | | |
| D | 0.0 | 0.0 | 0.0 | 0.0 | 0.0 | 0.0 | | | | | | | | | | | | | | | | | | | | | | | | | | | | | | | | | | | | | | | | | | | | | | | | | | | | | | | | | | | | | | | | | | | | | | | | | | | | | | | | | | | | | | | | | | | | | | | | | | | | | | | | | | | | | | | | | | | | | | | | | | | | | | | | | | | | | | | | | | | | | | | | | | | | | | | | | | | | | | | | | | | | | | | | | | | | | | | | | | | | | | | | | | | | | | | | | | | | | | | | | | | | | | | | | | | | | | | | | | | | | | | | | | | | | | | | | | | | | | | | | | | | | | | | | | | | | | | | | | | | | | | | | | | | | | | | | | | | | | | | | | | | | | | | | | | | | | | | | | | | | | | | | | | | | | | | | | | | | | | | | | | | | | | | | | | | | | | | | | | | | | | | | | | | | | | | | | | | | | | | | | | | | | | | | | | | | | | | | | | | | | | | | | | | | | | | | | | | | | | | | | | | | | | | | | | | | | | | | | | | | | | | | | | | | | | | | | | | | | | | | | | | | | | | | | | | | | | | | | | | | | | | | | | | | | | | | | | | | | | | | | | | | | | | | | | | | | | | | | | | | | | | | | | | | | | | | | | | | | | | | | | | | | | | | | | | | | | | | | | | | | | | | | | | | | | | | | | | | | | | | | | | | | | | | | | | |
| E | 0.1 | 0.1 | 0.1 | 0.2 | 0.4 | 0.4 | | | | | | | | | | | | | | | | | | | | | | | | | | | | | | | | | | | | | | | | | | | | | | | | | | | | | | | | | | | | | | | | | | | | | | | | | | | | | | | | | | | | | | | | | | | | | | | | | | | | | | | | | | | | | | | | | | | | | | | | | | | | | | | | | | | | | | | | | | | | | | | | | | | | | | | | | | | | | | | | | | | | | | | | | | | | | | | | | | | | | | | | | | | | | | | | | | | | | | | | | | | | | | | | | | | | | | | | | | | | | | | | | | | | | | | | | | | | | | | | | | | | | | | | | | | | | | | | | | | | | | | | | | | | | | | | | | | | | | | | | | | | | | | | | | | | | | | | | | | | | | | | | | | | | | | | | | | | | | | | | | | | | | | | | | | | | | | | | | | | | | | | | | | | | | | | | | | | | | | | | | | | | | | | | | | | | | | | | | | | | | | | | | | | | | | | | | | | | | | | | | | | | | | | | | | | | | | | | | | | | | | | | | | | | | | | | | | | | | | | | | | | | | | | | | | | | | | | | | | | | | | | | | | | | | | | | | | | | | | | | | | | | | | | | | | | | | | | | | | | | | | | | | | | | | | | | | | | | | | | | | | | | | | | | | | | | | | | | | | | | | | | | | | | | | | | | | | | | | | | | | | | | | | | | | | | |

11.2 Tables of Degree of Difficulties

| Dive Number | Dive description | DD TABLE - 12 mts | | | | | DD TABLE - 15 mts | | | | |
|--------------------------|--|-------------------|-----|-----|-----|-----|-------------------|-----|-----|-----|-----|
| | | A | B | C | D | E | A | B | C | D | E |
| Group 1 - Forward | | | | | | | | | | | |
| 102 | Forward 1 Somersault | 2,7 | 2,5 | 2,4 | | 2,6 | 2,8 | 2,6 | 2,5 | | 2,7 |
| 104 | Forward 2 Somersaults | | 3,1 | 2,9 | | 3,2 | | 3,2 | 3,0 | | 3,3 |
| 106 | Forward 3 Somersaults | | 4,2 | 4,0 | | 4,4 | | 4,0 | 3,8 | | 4,2 |
| 108 | Forward 4 Somersaults | | 5,9 | 5,6 | | | | 5,4 | 5,1 | | |
| 112 | Forward Flying 1 Somersault | | 2,6 | 2,5 | | | | 2,7 | 2,6 | | |
| 114 | Forward Flying 2 Somersaults | | 3,2 | 3,0 | | | | 3,3 | 3,1 | | |
| 116 | Forward Flying 3 Somersaults | | 4,4 | 4,1 | | | | 4,2 | 3,9 | | |
| 5121 | Forward 1 Somersault 1/2 Twist | | | | 2,3 | | | | | 2,4 | |
| 5141 | Forward 2 Somersaults 1/2 Twist | | 2,8 | 2,6 | | 2,9 | | 2,9 | 2,7 | | 3,0 |
| 5(1)141 | Forward Flying 2 Somersaults 1/2 Twist | | 2,9 | 2,7 | | | | 3,0 | 2,8 | | |
| 5161 | Forward 3 Somersaults 1/2 Twist | | 3,8 | 3,6 | | 4,0 | | 3,6 | 3,4 | | 3,8 |
| 5(1)161 | Forward Flying 3 Somersaults 1/2 Twist | | 4,0 | 3,7 | | | | 3,8 | 3,5 | | |
| 5161m | Forward 3 Somersaults 1/2 Twist mid-turn | | 3,9 | 3,8 | | | | 3,7 | 3,6 | | |
| 5181 | Forward 4 Somersaults 1/2 Twist | | 5,3 | 5,0 | | | | 4,8 | 4,5 | | |
| 5(1)181 | Forward Flying 4 Somersaults 1/2 Twist | | 5,7 | 5,1 | | | | 5,2 | 4,6 | | |
| 5181m | Forward 4 Somersaults 1/2 Twist mid-turn | | 5,6 | 5,3 | | | | 5,1 | 4,8 | | |
| 5142 | Forward 2 Somersaults 1 Twist | | | | 3,4 | | | | | 3,5 | |
| 5143 | Forward 2 Somersaults 1 1/2 Twists | | | | 3,1 | | | | | 3,2 | |
| 5144 | Forward 2 Somersaults 2 Twists | | | | 4,0 | | | | | 4,0 | |
| 5145 | Forward 2 Somersaults 2 1/2 Twists | | | | 3,6 | | | | | 3,6 | |
| 5146 | Forward 2 Somersaults 3 Twists | | | | 4,8 | | | | | 4,6 | |
| 5147 | Forward 2 Somersaults 3 1/2 Twists | | | | 4,3 | | | | | 4,1 | |
| 5149 | Forward 2 Somersaults 4 1/2 Twists | | | | 5,2 | | | | | 4,7 | |
| 5162 | Forward 3 Somersaults 1 Twist | | 4,7 | 4,5 | | | | 4,5 | 4,3 | | |
| 5163 | Forward 3 Somersaults 1 1/2 Twist | | 4,3 | 4,1 | | | | 4,1 | 3,9 | | |
| 5164 | Forward 3 Somersaults 2 Twists | | 5,5 | 5,3 | | | | 5,2 | 5,0 | | |
| 5165 | Forward 3 Somersaults 2 1/2 Twists | | 5,0 | 4,8 | | | | 4,7 | 4,5 | | |
| Group 2 - Back | | | | | | | | | | | |
| 202 | Back 1 Somersault | 2,8 | 2,6 | 2,5 | | 2,7 | 2,9 | 2,7 | 2,6 | | 2,8 |
| 204 | Back 2 Somersaults | 3,3 | 3,1 | 2,9 | | 3,2 | 3,4 | 3,2 | 3,0 | | 3,3 |
| 206 | Back 3 Somersaults | | 4,4 | 4,2 | | 4,6 | | 4,2 | 4,0 | | 4,4 |
| 208 | Back 4 Somersaults | | 6,2 | 5,9 | | | | 5,7 | 5,4 | | |
| 212 | Back Flying 1 Somersault | | 2,7 | 2,6 | | | | 2,8 | 2,7 | | |
| 214 | Back Flying 2 Somersaults | | 3,2 | 3,0 | | | | 3,3 | 3,1 | | |
| 5241 | Back 2 Somersaults 1/2 Twist | | | | 3,4 | | | | | 3,5 | |
| 5242 | Back 2 Somersaults 1 Twist | | | | 3,1 | | | | | 3,2 | |
| 5243 | Back 2 Somersaults 1 1/2 Twist | | | | 3,8 | | | | | 3,8 | |
| 5244 | Back 2 Somersaults 2 Twists | | | | 3,5 | | | | | 3,5 | |
| 5245 | Back 2 Somersaults 2 1/2 Twists | | | | 4,5 | | | | | 4,3 | |
| 5246 | Back 2 Somersaults 3 Twists | | | | 4,1 | | | | | 3,9 | |
| 5248 | Back 2 Somersaults 4 Twists | | | | 4,9 | | | | | 4,5 | |
| 5261 | Back 3 Somersaults 1/2 Twist | | 4,7 | 4,5 | | | | 4,5 | 4,3 | | |
| 5262 | Back 3 Somersaults 1 Twist | | 4,2 | 4,0 | | | | 4,0 | 3,8 | | |
| 5263 | Back 3 Somersaults 1 1/2 Twist | | 5,3 | 5,1 | | | | 5,0 | 4,8 | | |
| 5264 | Back 3 Somersaults 2 Twists | | 4,8 | 4,6 | | | | 4,5 | 4,3 | | |
| 5265 | Back 3 Somersaults 2 1/2 Twist | | 6,2 | 6,0 | | | | 5,7 | 5,5 | | |
| 5266 | Back 3 Somersaults 3 Twists | | 5,6 | 5,4 | | | | 5,1 | 4,9 | | |
| 5282 | Back 4 Somersaults 1 Twist | | 5,8 | 5,5 | | | | 5,3 | 5,0 | | |
| Group 3 - Reverse | | | | | | | | | | | |
| 302 | Reverse 1 Somersault | 2,9 | 2,7 | 2,6 | | 2,8 | 2,9 | 2,7 | 2,6 | | 2,8 |
| 304 | Reverse 2 Somersaults | | 3,3 | 3,1 | | 3,4 | | 3,3 | 3,1 | | 3,4 |
| 306 | Reverse 3 Somersaults | | 4,5 | 4,3 | | | | 4,3 | 4,1 | | |
| 308 | Reverse 4 Somersaults | | 6,4 | 6,1 | | | | 5,9 | 5,6 | | |
| 312 | Reverse Flying 1 Somersault | | 2,8 | 2,7 | | | | 2,8 | 2,7 | | |
| 5341 | Reverse 2 Somersaults 1/2 Twist | | | | 3,5 | | | | | 3,6 | |
| 5342 | Reverse 2 Somersaults 1 Twist | | | | 3,2 | | | | | 3,3 | |
| 5343 | Reverse 2 Somersaults 1 1/2 Twist | | | | 3,9 | | | | | 4,0 | |
| 5344 | Reverse 2 Somersaults 2 Twists | | | | 3,6 | | | | | 3,7 | |

| Dive Number | Dive description | DD TABLE - 12 mts | | | | | DD TABLE - 15 mts | | | | |
|---------------------------|--|-------------------|-----|-----|-----|-----|-------------------|-----|-----|-----|-----|
| | | A | B | C | D | E | A | B | C | D | E |
| 5345 | Reverse 2 Somersaults 2 1/2 Twists | | | | 4,7 | | | | | 4,6 | |
| 5346 | Reverse 2 Somersaults 3 Twists | | | | 4,3 | | | | | 4,2 | |
| 5347 | Reverse 2 Somersaults 3 1/2 Twists | | | | 5,8 | | | | | 5,3 | |
| 5348 | Reverse 2 Somersaults 4 Twists | | | | 5,3 | | | | | 4,8 | |
| 5361 | Reverse 3 Somersaults 1/2 Twist | | 4,8 | 4,6 | | | | 4,6 | 4,4 | | |
| Group 4 - Inward | | | | | | | | | | | |
| 402 | Inward 1 Somersault | | 2,9 | 2,8 | | 3,0 | | 3,0 | 2,9 | | 3,1 |
| 404 | Inward 2 Somersaults | | 3,6 | 3,4 | | | | 3,7 | 3,5 | | |
| 406 | Inward 3 Somersaults | | 4,9 | 4,7 | | | | 4,7 | 4,5 | | |
| 412 | Inward Flying 1 Somersault | | 3,0 | 2,9 | | | | 3,1 | 3,0 | | |
| 5421 | Inward 1 Somersault 1/2 Twist | | | | 2,6 | | | | | 2,7 | |
| 5441 | Inward 2 Somersaults 1/2 Twist | | 3,2 | 3,0 | | 3,3 | | 3,3 | 3,1 | | 3,4 |
| 5461 | Inward 3 Somersaults 1/2 Twist | | 4,4 | 4,2 | | | | 4,2 | 4,0 | | |
| 5481 | Inward 4 Somersaults 1/2 Twist | | 6,2 | 5,9 | | | | 5,7 | 5,4 | | |
| 5442 | Inward 2 Somersaults 1 Twist | | | | 4,0 | | | | | 4,1 | |
| 5443 | Inward 2 Somersaults 1 1/2 Twist | | | | 3,6 | | | | | 3,7 | |
| Group 5 - Armstand | | | | | | | | | | | |
| 611 | Armstand Forward 1/2 Somersault | 2,6 | 2,4 | 2,3 | | | 2,7 | 2,5 | 2,4 | | |
| 613 | Armstand Forward 1 1/2 Somersaults | | 3,1 | 2,9 | | | | 3,2 | 3,0 | | |
| 615 | Armstand Forward 2 1/2 Somersaults | | 4,5 | 4,3 | | | | 4,3 | 4,1 | | |
| 6131 | Arm. Forward 1 1/2 Somersault 1/2 Twist | | | | 2,8 | | | | | 2,9 | |
| 6151 | Arm. Forward 2 1/2 Somersaults 1/2 Twist | | 4,0 | 3,8 | | | | 3,8 | 3,6 | | |
| 621 | Arm. Back 1/2 Somersault | 2,7 | 2,5 | 2,4 | | | 2,8 | 2,6 | 2,5 | | |
| 623 | Arm. Back 1 1/2 Somersault | 3,2 | 3,0 | 2,8 | | | 3,3 | 3,1 | 2,9 | | |
| 625 | Arm. Back 2 1/2 Somersaults | | 4,4 | 4,2 | | | | 4,2 | 4,0 | | |
| 631 | Arm. Reverse 1/2 Somersault | 2,8 | 2,6 | 2,5 | | | 2,9 | 2,7 | 2,6 | | |
| 633 | Arm. Reverse 1 1/2 Somersault | | 3,3 | 3,1 | | | | 3,4 | 3,2 | | |
| 635 | Arm. Reverse 2 1/2 Somersaults | | 4,5 | 4,3 | | | | 4,3 | 4,1 | | |
| 6132 | Arm. Forward 1 1/2 Somersault 1 Twist | | | | 3,6 | | | | | 3,7 | |
| 6133 | Arm. Forward 1 1/2 Somersault 1 1/2 Twist | | | | 3,3 | | | | | 3,4 | |
| 6134 | Arm. Forward 1 1/2 Somersault 2 Twists | | | | 4,4 | | | | | 4,4 | |
| 6135 | Arm. Forward 1 1/2 Somersault 2 1/2 Twists | | | | 4,0 | | | | | 4,0 | |
| 6152 | Arm. Forward 2 1/2 Somersaults 1 Twist | | 5,2 | 5,0 | | | | 4,9 | 4,7 | | |
| 6153 | Arm. Forward 2 1/2 Somersaults 1 1/2 Twist | | 4,7 | 4,5 | | | | 4,4 | 4,2 | | |
| 6271 | Arm Back 3 1/2 Somersaults 1/2 Twist | | 6,5 | 6,2 | | | | 6,0 | 5,7 | | |
| 6272 | Arm. Back 3 1/2 Somersaults 1 Twist | | 5,8 | 5,5 | | | | 5,3 | 5,0 | | |

| | |
|--|-----------------------------|
| | Blind entry |
| | Flying dive |
| | Back rotation control entry |

| Dive Number | Dive description | DD TABLE 27m | | | | | DD TABLE 20m | | | | |
|--------------------------|--|--------------|-----|-----|-----|-----|--------------|-----|-----|---|-----|
| | | A | B | C | D | E | A | B | C | D | E |
| Group 1 - Forward | | | | | | | | | | | |
| 102 | Forward 1 Somersault | | 2,8 | 2,7 | | 2,9 | | 2,7 | 2,6 | | 2,8 |
| 104 | Forward 2 Somersaults | | 3,2 | 3,0 | | 3,3 | | 3,1 | 2,9 | | 3,2 |
| 106 | Forward 3 Somersaults | | 3,8 | 3,6 | | | | 3,8 | 3,6 | | |
| 108 | Forward 4 Somersaults | | 4,7 | 4,4 | | | | 5,0 | 4,7 | | |
| 112 | Forward Flying 1 Somersault | | 2,9 | 2,8 | | | | 2,8 | 2,7 | | |
| 114 | Forward Flying 2 Somersaults | | 3,3 | 3,1 | | | | 3,2 | 3,0 | | |
| 116 | Forward Flying 3 Somersaults | | 4,0 | 3,7 | | | | 4,0 | 3,7 | | |
| 5121 | Forward 1 Somersault 1/2 Twist | | | | 2,6 | | | | | | 2,5 |
| 5141 | Forward 2 Somersaults 1/2 Twist | | 2,9 | 2,7 | | 3,0 | | 2,8 | 2,6 | | 2,9 |
| 5(1)141 | Forward Flying 2 Somersaults 1/2 Twist | | 3,0 | 2,8 | | | | 2,9 | 2,7 | | |
| 5161 | Forward 3 Somersaults 1/2 Twist | | 3,4 | 3,2 | | 3,6 | | 3,4 | 3,2 | | 3,6 |
| 5(1)161 | Forward Flying 3 Somersaults 1/2 Twist | | 3,6 | 3,3 | | | | 3,6 | 3,3 | | |
| 5161m | Forward 3 Somersaults 1/2 Twist mid-turn | | 3,5 | 3,4 | | | | 3,5 | 3,4 | | |
| 5181 | Forward 4 Somersaults 1/2 Twist | | 4,1 | 3,8 | | | | 4,4 | 4,1 | | |
| 5(1)181 | Forward Flying 4 Somersaults 1/2 Twist | | 4,5 | 3,9 | | | | | | | |
| 5181m | Forward 4 Somersaults 1/2 Twist mid-turn | | 4,4 | 4,1 | | | | 4,7 | 4,4 | | |
| 51(10)1 | Forward 5 Somersaults 1/2 Twist | | 5,1 | 4,6 | | | | | | | |
| 51(12)1 | Forward 6 Somersaults 1/2 Twist | | | | | | | | | | |
| 5142 | Forward 2 Somersaults 1 Twist | | | | 3,5 | | | | | | 3,4 |
| 5143 | Forward 2 Somersaults 1 1/2 Twist | | | | 3,2 | | | | | | 3,1 |
| 5144 | Forward 2 Somersaults 2 Twists | | | | 4,0 | | | | | | 3,9 |
| 5145 | Forward 2 Somersaults 2 1/2 Twists | | | | 3,6 | | | | | | 3,5 |
| 5146 | Forward 2 Somersaults 3 Twists | | | | 4,6 | | | | | | 4,5 |
| 5147 | Forward 2 Somersaults 3 1/2 Twists | | | | 4,1 | | | | | | 4,0 |
| 5149 | Forward 2 Somersaults 4 1/2 Twists | | | | 4,7 | | | | | | 4,6 |
| 5162 | Forward 3 Somersaults 1 Twist | | 4,2 | 4,0 | | | | 4,3 | 4,1 | | |
| 5163 | Forward 3 Somersaults 1 1/2 Twist | | 3,8 | 3,6 | | | | 3,9 | 3,7 | | |
| 5164 | Forward 3 Somersaults 2 Twists | | 4,8 | 4,6 | | | | 5,0 | 4,8 | | |
| 5165 | Forward 3 Somersaults 2 1/2 Twists | | 4,3 | 4,1 | | | | 4,5 | 4,3 | | |
| 5166 | Forward 3 Somersaults 3 Twists | | | | 5,5 | | | | | | 5,8 |
| 5167 | Forward 3 Somersaults 3 1/2 Twists | | | | 4,9 | | | | | | |
| 5169 | Forward 3 Somersaults 4 1/2 Twists | | | | 5,6 | | | | | | |
| 5182 | Forward 4 Somersaults 1 Twist | | 5,3 | 5,0 | | | | | | | |
| 5183 | Forward 4 Somersaults 1 1/2 Twist | | 4,7 | 4,4 | | | | | | | |
| 5185 | Forward 4 Somersaults 2 1/2 Twists | | 5,4 | 5,1 | | | | | | | |
| 5187 | Forward 4 Somersaults 3 1/2 twists | | 6,2 | 5,9 | | | | | | | |
| Group 2 - Back | | | | | | | | | | | |
| 202 | Back 1 Somersault | 2,9 | 2,7 | 2,6 | | 2,8 | 2,9 | 2,7 | 2,6 | | 2,8 |
| 204 | Back 2 Somersaults | 3,3 | 3,1 | 2,9 | | | 3,4 | 3,2 | 3,0 | | |
| 206 | Back 3 Somersaults | | 3,8 | 3,6 | | | | 4,0 | 3,8 | | |
| 208 | Back 4 Somersaults | | 4,6 | 4,3 | | | | 5,2 | 4,9 | | |
| 20(10) | Back 5 Somersaults | | 5,8 | 5,3 | | | | | | | |
| 212 | Back Flying 1 Somersault | | 2,8 | 2,7 | | | | 2,8 | 2,7 | | |
| 214 | Back Flying 2 Somersaults | | 3,2 | 3,0 | | | | 3,3 | 3,1 | | |
| 216 | Back Flying 3 Somersaults | | 4,0 | 3,7 | | | | 4,2 | 3,9 | | |
| 5241 | Back 2 Somersaults 1/2 Twist | | | | 3,4 | | | | | | 3,4 |
| 5242 | Back 2 Somersaults 1 Twist | | | | 3,1 | | | | | | 3,1 |
| 5243 | Back 2 Somersaults 1 1/2 Twist | | | | 3,7 | | | | | | 3,7 |
| 5244 | Back 2 Somersaults 2 Twists | | | | 3,4 | | | | | | 3,4 |
| 5245 | Back 2 Somersaults 2 1/2 Twists | | | | 4,2 | | | | | | 4,2 |
| 5246 | Back 2 Somersaults 3 Twists | | | | 3,8 | | | | | | 3,8 |
| 5247 | Back 2 Somersaults 3 1/2 Twists | | | | 4,8 | | | | | | |
| 5248 | Back 2 Somersaults 4 Twists | | | | 4,3 | | | | | | 4,4 |
| 524(10) | Back 2 Somersaults 5 Twists | | | | 5,0 | | | | | | |
| 5261 | Back 3 Somersaults 1/2 Twist | | 4,2 | 4,0 | | | | 4,3 | 4,1 | | |

| Dive Number | Dive description | DD TABLE 27m | | | | | DD TABLE 20m | | | | |
|--------------------------|-------------------------------------|--------------|-----|-----|-----|-----|--------------|-----|-----|-----|-----|
| | | A | B | C | D | E | A | B | C | D | E |
| 5262 | Back 3 Somersaults 1 Twist | | 3,7 | 3,5 | | | | 3,8 | 3,6 | | |
| 5263 | Back 3 Somersaults 1 1/2 Twist | | 4,6 | 4,4 | | | | 4,8 | 4,6 | | |
| 5264 | Back 3 Somersaults 2 Twists | | 4,1 | 3,9 | | | | 4,3 | 4,1 | | |
| 5265 | Back 3 Somersaults 2 1/2 Twist | | 5,2 | 5,0 | | | | | | | |
| 5266 | Back 3 Somersaults 3 Twists | | 4,6 | 4,4 | | | | 4,9 | 4,7 | | |
| 5267 | Back 3 Somersaults 3 1/2 Twists | | | | 5,9 | | | | | | |
| 5268 | Back 3 Somersaults 4 Twists | | | | 5,2 | | | | | | |
| 526(10) | Back 3 Somersaults 5 Twists | | | | 6,0 | | | | | | |
| 5281 | Back 4 Somersaults 1/2 Twist | | 5,2 | 4,9 | | | | | | | |
| 5282 | Back 4 Somersaults 1 Twist | | 4,5 | 4,2 | | | | 4,9 | 4,6 | | |
| 5282m | Back 4 Somersaults 1 Twist mid-turn | | 4,8 | 4,5 | | | | | | | |
| 5283 | Back 4 Somersaults 1 1/2 Twist | | 5,8 | 5,5 | | | | | | | |
| 5284 | Back 4 Somersaults 2 Twists | | 5,1 | 4,8 | | | | | | | |
| 5286 | Back 4 Somersaults 3 Twists | | 5,8 | 5,5 | | | | | | | |
| 52(10)2 | Back 5 Somersaults 1 Twist | | 5,6 | 5,1 | | | | | | | |
| Group 3 - Reverse | | | | | | | | | | | |
| 302 | Reverse 1 Somersault | 2,9 | 2,7 | 2,6 | | 2,8 | 2,9 | 2,7 | 2,6 | | 2,8 |
| 304 | Reverse 2 Somersaults | | 3,1 | 2,9 | | | | 3,2 | 3,0 | | |
| 306 | Reverse 3 Somersaults | | 3,9 | 3,7 | | | | 4,1 | 3,9 | | |
| 308 | Reverse 4 Somersaults | | 4,8 | 4,5 | | | | 5,4 | 5,1 | | |
| 30(10) | Reverse 5 Somersaults | | 6,1 | 5,6 | | | | | | | |
| 312 | Reverse Flying 1 Somersault | | 2,8 | 2,7 | | | | 2,8 | 2,7 | | |
| 5341 | Reverse 2 Somersaults 1/2 Twist | | | | 3,4 | | | | | 3,4 | |
| 5342 | Reverse 2 Somersaults 1 Twist | | | | 3,1 | | | | | 3,1 | |
| 5343 | Reverse 2 Somersaults 1 1/2 Twist | | | | 3,8 | | | | | 3,8 | |
| 5344 | Reverse 2 Somersaults 2 Twists | | | | 3,5 | | | | | 3,5 | |
| 5345 | Reverse 2 Somersaults 2 1/2 Twists | | | | 4,4 | | | | | 4,4 | |
| 5346 | Reverse 2 Somersaults 3 Twists | | | | 4,0 | | | | | 4,0 | |
| 5347 | Reverse 2 Somersaults 3 1/2 Twists | | | | 5,1 | | | | | 5,2 | |
| 5348 | Reverse 2 Somersaults 4 Twists | | | | 4,6 | | | | | | |
| 534(10) | Reverse 2 Somersaults 5 Twists | | | | 5,4 | | | | | | |
| 5361 | Reverse 3 Somersaults 1/2 Twist | | 4,3 | 4,1 | | | | 4,4 | 4,2 | | |
| 5362 | Reverse 3 Somersaults 1 Twist | | 3,8 | 3,6 | | | | 3,9 | 3,7 | | |
| 5363 | Reverse 3 Somersaults 1 1/2 Twist | | 4,9 | 4,7 | | | | | | | |
| 5364 | Reverse 3 Somersaults 2 Twists | | 4,4 | 4,2 | | | | | | | |
| 5365 | Reverse 3 Somersaults 2 1/2 Twists | | 5,7 | 5,5 | | | | | | | |
| 5366 | Reverse 3 Somersaults 3 Twists | | 5,1 | 4,9 | | | | | | | |
| 5381 | Reverse 4 Somersaults 1/2 Twist | | 5,4 | 5,1 | | | | | | | |
| 5382 | Reverse 4 Somersaults 1 Twist | | 4,7 | 4,4 | | | | | | | |
| Group 4 - Inward | | | | | | | | | | | |
| 402 | Inward 1 Somersault | | 2,9 | 2,8 | | | | 3,0 | 2,9 | | |
| 404 | Inward 2 Somersaults | | 3,5 | 3,3 | | | | 3,6 | 3,4 | | |
| 406 | Inward 3 Somersaults | | 4,3 | 4,1 | | | | 4,5 | 4,3 | | |
| 408 | Inward 4 Somersaults | | 5,4 | 5,1 | | | | 5,9 | 5,6 | | |
| 412 | Inward Flying 1 Somersault | | 3,0 | 2,9 | | | | 3,1 | 3,0 | | |
| 5421 | Inward 1 Somersault 1/2 Twist | | | | 2,6 | | | | | 2,7 | |
| 5441 | Inward 2 Somersaults 1/2 Twist | | 3,1 | 2,9 | | | | 3,2 | 3,0 | | |
| 5461 | Inward 3 Somersaults 1/2 Twist | | 3,8 | 3,6 | | | | 4,0 | 3,8 | | |
| 5481 | Inward 4 Somersaults 1/2 Twist | | 4,7 | 4,4 | | | | 5,2 | 4,9 | | |
| 54(10)1 | Inward 5 Somersaults 1/2 Twist | | 5,9 | 5,4 | | | | | | | |
| 5442 | Inward 2 Somersaults 1 Twist | | | | 3,9 | | | | | | |
| 5443 | Inward 2 Somersaults 1 1/2 Twist | | | | 3,5 | | | | | 3,6 | |
| 5445 | Inward 2 Somersaults 2 1/2 Twists | | | | 4,0 | | | | | 4,1 | |
| 5447 | Inward 2 Somersaults 3 1/2 Twists | | | | 4,6 | | | | | | |
| 5462 | Inward 3 Somersaults 1 Twist | | 4,8 | 4,6 | | | | | | | |

| Dive Number | Dive description | DD TABLE 27m | | | | | DD TABLE 20m | | | | |
|---------------------------|---|--------------|-----|-----|-----|---|--------------|-----|-----|---|-----|
| | | A | B | C | D | E | A | B | C | D | E |
| 5463 | Inward 3 Somersaults 1 1/2 Twist | | 4,3 | 4,1 | | | | | | | |
| Group 5 - Armstand | | | | | | | | | | | |
| 611 | Armstand Forward 1/2 Somersault | | 2,7 | 2,6 | | | | 2,6 | 2,5 | | |
| 613 | Armstand Forward 1 1/2 Somersaults | | 3,3 | 3,1 | | | | 3,2 | 3,0 | | |
| 615 | Armstand Forward 2 1/2 Somersaults | | 4,2 | 4,0 | | | | 4,2 | 4,0 | | |
| 6131 | Arm. Forward 1 1/2 Somersault 1/2 Twist | | | | 3,0 | | | | | | 2,9 |
| 6151 | Arm. Forward 2 1/2 Somersaults 1/2 Twist | | 3,7 | 3,5 | | | | 3,7 | 3,5 | | |
| 6171 | Arm. Forward 3 1/2 Somersaults 1/2 Twist | | 4,6 | 4,3 | | | | | | | |
| 621 | Arm. Back 1/2 Somersault | 2,8 | 2,6 | 2,5 | | | 2,8 | 2,6 | 2,5 | | |
| 623 | Arm. Back 1 1/2 Somersault | 3,3 | 3,1 | 2,9 | | | 3,3 | 3,1 | 2,9 | | |
| 625 | Arm. Back 2 1/2 Somersaults | | 3,8 | 3,6 | | | | 4,0 | 3,8 | | |
| 627 | Arm. Back 3 1/2 Somersaults | | 4,8 | 4,5 | | | | | | | |
| 629 | Arm. Back 4 1/2 Somersaults | | 6,1 | 5,6 | | | | | | | |
| 631 | Arm. Reverse 1/2 Somersault | | 2,7 | 2,6 | | | | 2,7 | 2,6 | | |
| 633 | Arm. Reverse 1 1/2 Somersault | | 3,3 | 3,1 | | | | 3,3 | 3,1 | | |
| 635 | Arm. Reverse 2 1/2 Somersaults | | 4,1 | 3,9 | | | | 4,2 | 4,0 | | |
| 637 | Arm. Reverse 3 1/2 Somersaults | | 5,1 | 4,8 | | | | 5,5 | 5,2 | | |
| 6132 | Arm. Forward 1 1/2 Somersault 1 Twist | | | | 3,6 | | | | | | 3,5 |
| 6133 | Arm. Forward 1 1/2 Somersault 1 1/2 Twist | | | | 3,3 | | | | | | 3,2 |
| 6134 | Arm. Forward 1 1/2 Somersault 2 Twists | | | | 4,1 | | | | | | 4,0 |
| 6135 | Arm. Forward 1 1/2 Somersault 2 1/2 Twists | | | | 3,7 | | | | | | 3,6 |
| 6152 | Arm. Forward 2 1/2 Somersaults 1 Twist | | 4,6 | 4,4 | | | | 4,6 | 4,4 | | |
| 6153 | Arm. Forward 2 1/2 Somersaults 1 1/2 Twist | | 4,1 | 3,9 | | | | 4,1 | 3,9 | | |
| 6154 | Arm. Forward 2 1/2 Somersaults 2 Twists | | | | 5,2 | | | | | | |
| 6155 | Arm. Forward 2 1/2 Somersaults 2 1/2 Twists | | | | 4,6 | | | | | | |
| 6156 | Arm. Forward 2 1/2 Somersaults 3 Twists | | | | 5,9 | | | | | | |
| 6157 | Arm. Forward 2 1/2 Somersaults 3 1/2 Twists | | | | 5,2 | | | | | | |
| 6173 | Arm. Forward 3 1/2 Somersaults 1 1/2 Twist | | 5,2 | 4,9 | | | | | | | |
| 6231 | Arm Back 1 1/2 Somersault 1/2 Twist | | | | 3,3 | | | | | | 3,2 |
| 6232 | Arm. Back 1 1/2 Somersault 1 Twist | | | | 3,0 | | | | | | 2,9 |
| 6233 | Arm Back 1 1/2 Somersault 1 1/2 Twist | | | | 3,7 | | | | | | 3,5 |
| 6251 | Arm Back 2 1/2 Somersault 1/2 Twist | | 4,1 | 3,9 | | | | 4,2 | 4,0 | | |
| 6252 | Arm. Back 2 1/2 Somersaults 1 Twist | | 3,6 | 3,4 | | | | 3,7 | 3,5 | | |
| 6253 | Arm Back 2 1/2 Somersaults 1 1/2 Twist | | 4,6 | 4,4 | | | | 4,7 | 4,5 | | |
| 6254 | Arm. Back 2 1/2 Somersaults 2 Twists | | 4,1 | 3,9 | | | | 4,2 | 4,0 | | |
| 6255 | Arm Back 2 1/2 Somersaults 2 1/2 Twists | | | | 5,3 | | | | | | |
| 6256 | Arm. Back 2 1/2 Somersaults 3 Twists | | | | 4,7 | | | | | | 4,8 |
| 6257 | Arm Back 2 1/2 Somersaults 3 1/2 Twists | | | | 6,1 | | | | | | |
| 6258 | Arm. Back 2 1/2 Somersaults 4 Twists | | | | 5,4 | | | | | | |
| 625(10) | Arm. Back 2 1/2 Somersaults 5 Twists | | | | 6,2 | | | | | | |
| 6271 | Arm Back 3 1/2 Somersaults 1/2 Twist | | 5,2 | 4,9 | | | | | | | |
| 6272 | Arm. Back 3 1/2 Somersaults 1 Twist | | 4,5 | 4,2 | | | | | | | |
| 6273 | Arm Back 3 1/2 Somersaults 1 1/2 Twist | | 5,9 | 5,6 | | | | | | | |
| 6274 | Arm. Back 3 1/2 Somersault 2 Twists | | 5,2 | 4,9 | | | | | | | |

| | |
|--|-----------------------------|
| | Blind Entry |
| | Flying dive |
| | Back rotation control entry |

PART SIX: WATER POLO RULES

1. THE FIELD OF PLAY & EQUIPMENT

1.1 Features of the field of play, goals, ball and other equipment must be in accordance with Appendix 4.

1.2 The distance between the goal lines shall not be less than 20 metres and not more than 30 metres for games played by men. The distance between the goal lines shall not be less than 20 metres and not more than 25 metres for games played by women. The width of the field of play shall be not less than 10 metres and not more than 20 metres.

1.3 An area for flying substitutions must be available on the lateral outer side of the field of play, on the side where the team benches are situated. The width of this area must be between 0.5m – 1m. The designated area for flying substitutions for each team will be between the goal line in front of the team bench and the centre of the field of play.

2. TEAMS & PLAYERS

Team composition

2.1 Each team must consist of a maximum of thirteen players: eleven field players and two goalkeepers. A team must start the game with not more than seven players, one of whom shall be the goalkeeper and who shall wear the goalkeeper's cap. Five reserves may be used as substitutes and one reserve goalkeeper who may be used only as a substitute goalkeeper. A team playing with less than seven players shall not be required to have a goalkeeper. If a team has no more substitutes apart from the substitute goalkeeper, either the goalkeeper or substitute goalkeeper, if applicable, may play as a field player.

2.2 All players not in the game at that time, together with the coaches and officials except for the head coach, must sit on the team bench and shall not move away from the bench from the commencement of play, except for substitutions and during the intervals between periods or during timeouts. The head coach

of the attacking team may move to the 6 metre line at any time. Teams must only change ends and benches at half time. The team benches must both be situated on the side opposite to the official table.

2.3 The captains shall be playing members of their respective teams and, together with the head coach, they shall be responsible for the good conduct and discipline of the team.

2.4 Players shall wear non-transparent costumes or costumes with a separate undergarment and before taking part in a game shall remove any articles likely to cause injury.

2.5 Players shall not have grease, oil or any substance on the body, which might provide an advantage. If a referee determines before the start of play that such a substance has been used, the referee shall order it to be removed immediately. The start of play shall not be delayed for the substance to be removed. If the offence is detected after the play has started, the offending player shall be excluded from the remainder of the game and a substitute permitted to enter the field of play immediately from the team's exclusion re-entry area.

Substitution procedure

2.6 At any time in the game, a player or goalkeeper may be substituted by leaving the field of play at the team's exclusion re-entry area. The substitute may enter the field of play from the exclusion re-entry area as soon as the player has visibly risen to the surface of the water within the re-entry area and touched hands above the water with the substitute. Substitution from the 'flying substitution' area is also allowed when the substitute enters the area from behind the extended goal line, both players, the exiting player and the substitute, are in the water, outside of the field of play and touch hands above the water. A substitute shall be ready to replace a player, without delay. If the substitute is not ready, the game shall continue without the substitute and, at any time, the substitute may then enter the field of play from the team's designated substitution areas, after touching hands where applicable.

2.7 If a goalkeeper is substituted under this Rule, it must only

be by the substitute goalkeeper, if applicable. No substitution shall be made under this Rule between the time a referee awards a penalty throw and the taking of the throw or during VAR review. If the goalkeeper or substitute goalkeeper, if applicable, is not entitled or able to participate, a team playing with seven players shall be required to play with an alternative goalkeeper who shall wear the goalkeeper's cap. A goalkeeper who has been replaced by a substitute may not play in any position other than goalkeeper.

2.8 No substitution shall be made, except for bleeding, between the time a referee awards a penalty throw and the taking of the throw or during VAR review.

2.9 A substitute may enter the field of play from any place: (a) during the intervals between periods of play; (b) after a goal has been scored; (c) during a timeout; (d) to replace a player who is bleeding or injured.

2.10 If a player, on the player's own initiative, leaves the field of play for other than a substitution from the designated lateral substitution area in a place other than the exclusion re-entry area or the designated lateral substitution area, this player will not be punished for leaving the field of play and this player or a substitute will be able to (re-)enter the field of play from the exclusion re-entry area only with permission of the referee. The player may also re-enter after a goal, after a timeout or at the start of the next period.

3. REFEREES AND TECHNICAL OFFICIALS

3.1 For World Aquatics events, the officials shall consist of two referees, two assistant referees, timekeepers and secretaries and a video assistant referee, each with the powers and duties specified in Appendix 5 and following the procedures specified in Appendix 7, if applicable.

3.2 To enforce the Rules, the referees shall be in absolute control of the game and their authority over players, team

officials and spectators shall be effective from the moment they enter until they leave the venue of the match.

3.3 The referees shall have the power:

(i) to award or not award any ordinary, exclusion or penalty foul, while encouraging action and the advantage of the attacking team. A referee may award a foul or refrain from awarding a foul if awarding the foul would be an advantage to the offending player's team;

(ii) to order the removal from the precincts of the pool or the venue any player, substitute, spectator or official whose behaviour prevents the referees from carrying out their duties in a proper and impartial manner;

(iii) to abandon the game at any time if the behaviour of the players or spectators, or other circumstances prevent it from being brought to a proper conclusion.

4. DURATION OF THE GAME

4.1 The duration of the game shall be four periods each of eight minutes actual play. Time shall commence at the start of each period when a player touches the ball. At all signals for stoppages, the time shall be stopped until the ball is put back into play by the ball leaving the hand of the player taking the appropriate throw or until the ball is touched by a player following a neutral throw.

4.2 There shall be a two-minute interval between the first and second periods and between the third and fourth periods and a three-minute interval between the second and third periods. The teams, including the players, coaches and officials, shall change ends before starting the third period.

4.3 Each World Aquatics Water Polo game shall have a winner at full time in any game. There shall be a penalty shoot out to determine the result as specified in Appendix 6

4.4 If a game (or part of a game) must be replayed, then goals,

personal fouls, and timeouts that occurred during the time to be replayed are deleted from the game score sheet, however exclusions for violent action, misconduct, and any red card exclusions are recorded on the game score sheet.

5. TIMEOUTS

5.1 Each team may request two timeouts per game. The duration of the timeout shall be one minute. A timeout may be requested at any time, including after a goal, but not after a penalty throw has been awarded or during VAR review, by the coach of the team in possession of the ball calling “timeout” and signalling to the secretary or referee with the hands forming a T-shape. A team has possession of the ball when one of its players is holding or swimming with the ball. If a timeout is requested, the secretary or referee shall immediately stop the game by whistle and the players shall immediately return to their respective halves of the field of play. The timeout request can also be made by any device authorized for use in the game.

5.2 Play shall be restarted on the whistle of the referee by the team in possession of the ball putting the ball into play on or behind the half distance line, except that if the timeout is requested before the taking of a corner throw, that throw shall be maintained.

5.3 If the coach of the team in possession of the ball requests an additional timeout to which the team is not entitled, the game shall be stopped, and play shall then be restarted by a player of the opposing team putting the ball into play at the half distance line.

5.4 If the coach of the team not in possession of the ball requests a timeout, the game shall be stopped, and a penalty throw awarded to the opposing team. After requesting this illegal timeout, the coach shall lose the right to request a legal timeout if the team still has one.

5.5 At the restart following a timeout, players may take any

position in the field of play, subject to the Rules relating to the taking of corner throws.

6. START AND RESTART OF PLAY

6.1 The first team listed in the official program will wear white caps or the caps reflecting the colour of their country and will start the game to the left of the official table. The other team will wear blue caps or caps of a contrasting colour and will start the game to the right of the table.

6.2 At the start of each period, the players must take up positions on their respective goal lines, about one metre apart and at least one metre from the goal posts. Not more than two players shall be allowed between the goal posts. No part of a player's body shall be beyond the goal line at water level.

6.3 When the referees are satisfied that the teams are ready, a referee shall blow the whistle to start and then release or throw the ball into play on the half distance line.

6.4 After a goal has been scored, the players shall take up positions anywhere within their respective halves of the field of play. No part of a player's body shall be beyond the half distance line at water level. A referee shall restart the game by blowing the whistle. At the time of the restart, actual play shall resume when the ball leaves the hand of a player of the team not having scored the goal. A restart not taken in accordance with this Rule shall be retaken.

7. METHOD OF SCORING

7.1 A goal shall be scored when the entire ball has passed fully over the goal line, between the goal posts and underneath the crossbar. The goal line is an imaginary laser line which runs on the front side from one goal post to the other post. A goal is scored when the ball fully passed the goal line as in position D and may be scored from anywhere within the field of play by any

part of the body except a clenched fist.

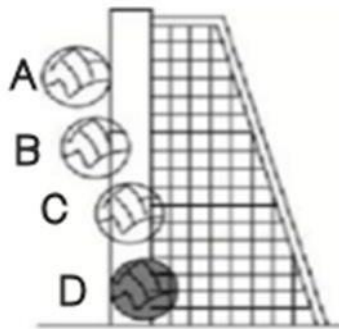

7.2 A goal may be scored:

- a) at the start or any restart of the game, after at least two players (of either team but excluding the defending goalkeeper) intentionally play or touch the ball;
- b) from a penalty throw;
- c) if a player throws the ball from a free throw into the player's own goal;
- d) from an immediate shot from a goal throw or a corner throw or a free throw awarded outside 6 metres;
- e) by a player who visibly puts the ball into play when starting or restarting play outside 6 metres:
 - i. after a swim up or the commencement of a period;
 - ii. after a timeout or a goal;
 - iii. after an injury;
 - iv. after replacement of a cap;
 - v. after the referee calls for the ball or calls for a neutral throw;
 - vi. when the ball leaves the side of the field of play;
 - vii. taking a free throw awarded outside 6 metres;
 - viii. after any other delay.

7.3 A goal shall be scored if, at the expiration of 20 or 30

seconds possession or at the end of a period, the ball is in flight or moving toward the goal and enters the goal, including after bouncing off the water, hitting the goal post, crossbar, goalkeeper, or another player, except when intentionally played or touched by another attacking player.

8. ORDINARY FOULS

8.1 It shall be an ordinary foul to commit any of the following offences (VI.8.2 to VI.8.15), which shall be punished by awarding of a free throw to the opposing team, except as otherwise provided by the Rules.

8.2 To advance beyond the goal line at the start of a period, before the referee has given the signal to start. The free throw shall be taken from the location of the ball or, if the ball has not been released into the field of play, from the half distance line.

8.3 To assist a player at the start of a period or at any other time during the game.

8.4 To hold or push off from the goal posts or their fixtures, to hold or push off from the sides or ends of the pool during actual play or at the start of a period.

8.5 To take any active part in the game when standing on the floor of the pool, to walk when play is in progress or to jump from the floor of the pool to play the ball or tackle an opponent. This rule shall not apply to the goalkeeper while within the goalkeeper's 6 metre area.

8.6 To take or hold the entire ball under the water when tackled or to deliberately hide it from the opposing team.

8.7 To strike at the ball with a clenched fist, unless by the goalkeeper while within the 6 metre area.

8.8 To play or touch the ball with two hands at the same time, unless by the goalkeeper while within the 6 metre area.

8.9 To push or push off from an opponent who is not holding

the ball.

8.10 To be within the opponent's goal area except when behind the line of the ball. It shall not be an offence if a player is inside the 2 metre line but outside the goal area. Any player who is behind the line of the ball can enter the goal area to receive the ball. Any player inside the goal area who does not shoot but passes the ball backwards has to leave the goal area immediately to avoid being sanctioned under this rule.

8.11 To take a free throw, goal throw, corner throw or a penalty throw other than in the prescribed manner except under the circumstances provided by VI 12.2 and VI13.4.

8.12 For a team to retain possession of the ball without shooting at the opponent's goal for more than: (i) 30 seconds of actual play, or (ii) 20 seconds in the case of an exclusion, corner throw or rebound to the attacking team after a shot, including after a penalty shot.

The timekeeper recording the possession time shall reset the clock:

- (a) when the ball has left the hand of the player shooting at goal. If the ball rebounds into play from the goal post, crossbar, a player or the goalkeeper, the possession time shall not recommence until the ball comes into the possession of one of the teams. The clock shall be reset to 20 seconds if the ball comes into possession of the attacking team. It shall be reset to 30 seconds if it comes into possession of the defending team;
- (b) when the ball comes into the possession of the defending team, the clock shall be reset to 30 seconds.
- (c) when the ball is put into play following the award of an exclusion foul to the defending player, the clock shall be reset to 20 seconds unless there are more than 20 seconds of possession time remaining, in which case the time shall continue and not be reset;
- (d) when the ball is put into play following the taking of a penalty throw without a change of possession or, corner throw, the clock shall be reset to 20 seconds;

(e) when the ball is put into play following the award of a penalty throw with a change of possession, a goal throw or neutral throw, the clock shall be reset to 30 seconds. Visible clocks shall show the time in a descending manner (that is, showing the possession time remaining).

8.13 To waste time.

8.14 To simulate being fouled.

8.15 To go under the water to gain positional advantage.

9. EXCLUSION FOULS

9.1 It shall be an exclusion foul to commit any of the following offences (VI 9.4 to VI 9.18) which shall be punished (except as otherwise provided by the Rules) by the award of a free throw to the opposing team and the exclusion of the player who committed the foul.

9.2 An excluded player, including a player excluded for the remainder of the game, must immediately leave the field of play, not leaving the water, and move to the exclusion re-entry area (visibly rising to the surface of the water and, if applicable, touch hands above the water with the substitute) nearest to the player's own goal line without interfering with the play.

9.3 The excluded player or a substitute shall be permitted to re-enter the field of play from the re-entry area nearest to the player's own goal line after the earliest occurrence when:

(a) 20 seconds of actual play have elapsed, at which time the secretary shall raise the appropriate flag;

(b) a goal has been scored; an excluded player or a substitute may re-enter the field of play from any place.

(c) the excluded player's team has retaken possession of the ball during actual play, at which time the defensive referee shall signal re-entry by a hand signal;

(d) the excluded player's team is awarded a free throw,

a goal throw or a penalty throw.

The excluded player or a substitute shall not be permitted to:

(i) jump or push off from the side or wall of the pool or the field of play;

(ii) affect the alignment of the goal;

(iii) enter for an excluded player until that player has reached the exclusion re-entry area nearest to the player's own goal line except between periods, after a goal, or during a timeout. These provisions shall also apply to the entry of a substitute when the excluded player has received three personal fouls or has otherwise been excluded from the remainder of the game in accordance with the Rules.

9.4 For a player to leave the water or sit or stand on the steps or side of the pool during play, except in the case of accident, injury, illness or with the permission of a referee. An excluded player who leaves the water (other than following the entry of a substitute) shall be deemed guilty of an offence under VI.9.13 (Misconduct).

9.5 To interfere with the taking of a free throw, goal throw or corner throw, including: (a) intentionally to throw away or fail to release the ball to prevent the normal progress of the game; (b) any attempt to play the ball before it has left the hand of the thrower.

9.6 To attempt to block a pass or shot with two hands outside the 6 metre area.

9.7 To intentionally splash in the face of an opponent.

9.8 To impede or otherwise prevent the free movement of an opponent who is not holding the ball, including swimming on the opponent's shoulders, back or legs. "Holding" is lifting, carrying or touching the ball but does not include dribbling the ball.

9.9 To hold, sink or pull back an opponent who is not holding the ball.

9.10 Anywhere in the field of play, to use two hands to hold an

opponent not holding the ball.

9.11 Tactical foul. Anywhere in the field of play, for a defending player to commit a foul on any player of the team in possession of the ball with the intent to stop the flow of the attack. This kind of foul is called a tactical foul.

9.12 To make disproportionate movements including kicking and striking.

9.13 To be guilty of misconduct, including the use of unacceptable language, aggressive play, refusing obedience to or showing disrespect for a referee or official, or behaviour against the spirit of the Rules and likely to bring the game into disrepute.

9.13.1 Should this occur during the game, the offending player shall be excluded from the remainder of the game, with substitution after the earliest occurrence referred to in VI.9.3, and must leave the competition area.

9.13.2 Should the incident occur during the interval between periods, during a timeout, or after a goal, the player shall be excluded for the remainder of the game and a substitute shall be eligible to re-enter immediately prior to the restart of the game and play will restart in the normal manner.

9.13.3 When one or more players of a team persist in repeated fouls other than aggressive play or misconduct or protest referees' or officials' decisions without the use of unacceptable language, the referee may show a yellow card to the offending team. Should the action continue, the referee will issue the offending player of the same team with a red card excluding the player for the remainder of the game according to VI.9.13 (misconduct).

9.14 To commit a violent action, including kicking, striking, or attempting to kick or strike with malicious intent an opponent or official, whether during actual play, during any stoppages, timeouts, after a goal has been scored or during intervals between periods of play. If the offending player is the goalkeeper, a substitute goalkeeper may be changed for another player in accordance with VI.2.6.

9.14.1 Should this occur during the game, the offending player shall be excluded for the remainder of the game and must leave the competition area and a penalty throw awarded to the opposing team. The offending player may be substituted when four minutes of actual play have elapsed.

9.14.2 Should the incident occur during any stoppage, timeout, after a goal or interval between periods of play, the player shall be excluded for the remainder of the game and must leave the competition area. No penalty throw shall be awarded. The offending player may be substituted when four minutes of actual play have elapsed. Play will restart in the normal manner.

9.14.3 If the referees call violent actions simultaneously on players of opposing teams during play, both players are excluded for the remainder of the game with substitution when four minutes of actual play have elapsed. The team, which had possession of the ball, will first shoot a penalty throw followed by the other team shooting a penalty throw. After the second penalty throw, the team, which had possession of the ball, will restart play with a free throw on or behind the half distance line.

9.15 In the case of simultaneous exclusion of players of opposing teams during play, both players are excluded for 20 seconds until the earliest occurrence referred to in VI.9.3 or at the next change of possession. The possession clock is not reset. Play is restarted with a free throw to the team which had possession of the ball. If neither team had possession when the simultaneous exclusions were called, the possession clock is reset to 30 seconds and play shall be restarted with a neutral throw. Both players excluded under this Rule, shall be permitted to re-enter at the next earliest occurrence referred to in VI.9.3 or at the next change of possession.

9.16 For an excluded player to re-enter or a substitute to enter the field of play improperly, including not following VI.2.6, VI.2.7 and VI.9.3. This player receives only one personal foul, which should be marked by the secretary as an exclusion foul.

9.16.1 If this offence is committed by a player of the team not in possession of the ball, the offending player shall be excluded and a penalty throw also awarded to the opposing team.

9.16.2 If this offence is committed by a player of the team in possession of the ball, the offending player shall be excluded and a free throw awarded to the opposing team.

9.17 To interfere with the taking of a penalty throw. The offending player shall be excluded from the remainder of the game with substitution after the earliest occurrence referred to in VI.9.3 and the penalty throw shall be maintained or re-taken as appropriate. The referees may use the VAR system to determine if there has been interference with the penalty throw. This offence may occur before the taking of the throw or after the whistle by the referee.

9.18 For the defending goalkeeper to fail to take up the correct position on the goal line at the taking of a penalty throw having been ordered once to do so by the referee. Another defending player may take the position of the goalkeeper but without the goalkeeper's privileges or limitations.

10. PENALTY FOULS

10.1 It shall be a penalty foul to commit any of the following offences (VI.10.2 to VI.10.11) which shall be punished by the award of a penalty throw to the opposing team. The referee can delay whistling and wait to see if the attacking player scores a goal in the same action. If the player does not score, the referee should sanction the penalty. The referee may raise an arm indicating a possible penalty.

10.2 For a goalkeeper or defending player to commit any foul within the 6 metre area if a goal would probably have resulted, including VI.10.4 to VI.10.7.

10.3 For an excluded player intentionally to interfere with play, including affecting the alignment of the goal. If the excluded player does not commence leaving the field of play almost immediately, the referee may deem this to be intentional interference under this Rule.

10.4 For a goalkeeper or defending player to pull over, pull down

or otherwise displace the goal.

10.5 Within the 6 metre area, for a defending player to attempt to block a pass or shot with two hands.

10.6 Within the 6 metre area, for a defending player to play the ball with a clenched fist.

10.7 Within the 6 metre area, for a goalkeeper or defending player to take the ball under the water when tackled.

10.8 For a player or substitute who is not entitled under the Rules to participate in the play at that time to enter the field of play. Also, the offending player shall be excluded from the remainder of the game with substitution. The substitute may enter the field of play after the earliest occurrence referred to in VI. 9.3.

10.9 For the coach, or any team official, of the team not in possession of the ball to request a timeout. No personal foul shall be recorded for this offence.

10.10 For the coach or any team official, or player to take any action with intent to prevent a probable goal or to delay the game, including:

- a) a defending player deliberately throwing the ball away before the attacking team can take a free throw
- b) a defending player, after a free throw outside the 6 metre line, deliberately pushing the ball inside 6 metre line, to avoid a direct shot.

No personal foul shall be recorded for this offence by the coach or any team official.

10.11 For a defending player to impede an attacking player from behind within the 6 metre area when the attacking player is facing the goal and making a shooting action, unless the defending player makes contact only with the ball. If the defending player's foul, described in this Rule, prevents the attacking player from scoring, a penalty must also be called. The referee must delay the call of penalty until the shot or attempted shot is completed and must award a penalty unless the

attacking player scores.

10.12 If, in the last minute of the game, a penalty throw is awarded to a team, the coach may elect to maintain possession of the ball and be awarded a free throw. The timekeeper recording possession time shall reset the clock to 30 seconds, and the game will be restarted as after a timeout.

It is the responsibility of the coach to give a clear signal without delay if the team wishes to maintain possession of the ball in accordance with this Rule.

11. FREE THROWS

11.1 A free throw shall be taken at the location of the ball, unless, after a foul committed by a defending player, the ball is inside the goal area. Then the free throw shall be taken on the 2 metre line opposite to the location of the ball. If the ball is outside of the goal area at the moment that the foul is awarded, the free throw shall be taken from the location of the ball.

11.2 A player awarded a free throw must put the ball into play with no undue delay, including by passing or by shooting, if permitted by the Rules. It shall be an ordinary foul if a player who is clearly in a position most readily to take a free throw does not do so. A defending player having committed a foul shall move away not less than 1 metre from the player taking the free throw before raising an arm to block a pass or shot; a player who fails to do so shall be excluded for “interference” under VI.9.5.

11.3 The free throw shall be taken with no undue delay by the player nearest to the ball in a manner to enable the players to observe the ball visibly leaving the hand of the player taking the throw, who shall also then be permitted to carry or dribble the ball before passing to another player, or to shoot, when permitted. The ball shall be in play immediately when it leaves the hand of the player taking the free throw.

11.4 A free throw is also awarded against the team which last touched the ball that went out of the side of the field of play (including the ball rebounding from the side of the field of play)

except in the case of a defensive field player blocking a shot over the side of the field of play, in which case a free throw is given to the defensive team.

12. GOAL THROWS

12.1 A goal throw shall be awarded when the entire ball has passed fully over the goal line excluding between the goal posts and underneath the crossbar, having last been touched by any player other than the goalkeeper of the defending team.

12.2 The goal throw shall be taken according to VI.11.3 without undue delay by any player of the team from anywhere within the 2 metre area or where the ball is, if outside 2 metres. A goal throw not taken in accordance with this Rule shall be retaken.

13. CORNER THROWS

13.1 A corner throw shall be awarded when the entire ball has passed fully over the goal line excluding between the goal posts and underneath the crossbar, having last been touched by the goalkeeper of the defending team or when a defending player deliberately sends the ball over the goal line.

13.2 The corner throw shall be taken according to VI.11.3 without undue delay by a player of the attacking team from the 2 metre mark on the side nearest to which the ball crossed the goal line. The throw does not need to be taken by the nearest player.

13.3 At the taking of a corner throw, no players of the attacking team shall be within the goal area.

13.4 A corner throw taken from the wrong position or before the players of the attacking team have left the goal area shall be retaken.

14. NEUTRAL THROWS

14.1 A neutral throw shall be awarded when:

- (a) at the start of a period, a referee is of the opinion that the ball has fallen in a position to the definite advantage of one team;
- (b) one or more players of opposing teams commit an ordinary foul at the same moment which makes it impossible for the referees to distinguish which player offended first;
- (c) both referees blow their whistles at the same moment to award ordinary fouls to the opposing teams;
- (d) neither team has possession of the ball and one or more players of opposing teams commit an exclusion foul at the same moment. The neutral throw shall be taken after the offending players have been excluded;
- (e) the ball strikes or lodges in an overhead obstruction.

14.2 At a neutral throw, a referee shall throw the ball into the field of play at approximately the same lateral position as the event occurred in such a manner as to allow the players of both teams to have an equal opportunity to reach the ball. A neutral throw awarded within the goal area shall be taken on the 2 metre line.

14.3 If at a neutral throw the referee is of the opinion that the ball has fallen in a position to the definite advantage of one team, the referee shall call for the ball and retake the throw.

15. PENALTY THROWS

15.1 A penalty throw shall be taken by any player of the team to which it is awarded from any point on the opponents' 5 metre line.

15.2 All players shall leave the 6 metre area and shall be at least three metres from the player taking the throw. On the 6 metre line, on each side of the player taking the throw, one player of

the defending team shall have the first right to take position. The defending goalkeeper shall be positioned between the goal posts with no part of the goalkeeper's body beyond the goal line at water level. The referees can give one warning to the players or the goalkeeper to take up the correct position. If that person does not do so, the player or goalkeeper shall be excluded and shall re-enter in accordance with VI.9.3.

15.3 When the referee controlling the taking of the throw is satisfied that the players are in their correct positions, the referee shall signal for the throw to be taken, by whistle and by simultaneously lowering the arm from a vertical to a horizontal position.

15.4 The player taking the penalty throw shall have possession of the ball and shall immediately throw it with an uninterrupted movement directly at the goal. The player may take the throw by lifting the ball from the water or with the ball held in the raised hand and the ball may be taken backwards from the direction of the goal in preparation for the forward throw, provided that the continuity of movement shall not be interrupted before the ball leaves the thrower's hand.

15.5 If the ball rebounds from the goal post, crossbar or goalkeeper it remains in play and it shall not be necessary for another player to play or touch the ball before a goal can be scored.

15.6 If at precisely the same time as the referee awards a penalty throw the timekeeper whistles for the end of a period, all players except the player taking the throw and the defending goalkeeper shall leave the water before the penalty throw is taken. In this situation, the ball shall immediately be dead should it rebound into play from the goal post, crossbar or the goalkeeper.

16. PERSONAL FOULS, YELLOW AND RED CARDS

16.1 A personal foul shall be recorded against any player who

commits an exclusion foul or penalty foul. The referee shall indicate the offending player's cap number to the secretary.

16.2 Upon receiving a third personal foul, a player shall be excluded from the remainder of the game with substitution after the earliest occurrence referred to in VI.9.3. If the third personal foul is a penalty foul, the entry of the substitute shall be immediate.

16.3 The referee, if necessary, must use Yellow and Red Cards to control the Team Officials and Substitute Players on the Team Bench as well as the players in the water. The use of Yellow and Red Cards applies to all World Aquatics Water Polo Competitions and will be administered as follows:

16.3.1 The issuing of a Yellow Card by the referee is an official warning to the Head Coach of the team.

16.3.2 The subsequent issuing of a Red Card by the referee is the signal that the Head Coach and/or other Team Official(s) and/or player(s) on the bench must leave pool area immediately. Should the actions of the Head Coach require it, the referee may issue a Red Card, without having issued a Yellow Card.

16.3.3 When the Head Coach is excluded from the game, another Team Official may replace the Head Coach, however without the privileges of the Head Coach. The Team Official is not allowed to stand and move away from the team bench but can ask for a timeout according to the Rules. During a timeout or after a goal, before the restart of the match, the Team Official may move freely along the side of the pool to the half distance line to instruct the team.

16.3.4 During the match, when a team member inside the water commits an act of misconduct, the referee must show a Red Card to the player accompanied by the appropriate sanction.

16.3.5 A referee may issue a Yellow Card, if, in the referee's opinion, a player persists in playing in an unsporting manner or engages in simulation (VI.8.4). The referee shall show a Yellow Card to the offending team and point to the offending player.

Should the action continue, the referee will show the player a Red Card visible to both the team and the official table as this is deemed to be misconduct (VI.9.13).

16.3.6 Team members committing an act of misconduct will be punished according to VI.9.13 and must leave the pool area immediately.

16.3.7 For any offense potentially leading to a player or team official being excluded from the remainder of a game, the Management Committee of the tournament shall assess all circumstances of the offense, in particular its gravity, and decide whether the player or team official shall be excluded from additional games in the tournament within 24 hours after the end of the game, with notification to the player, team official and team. The Management Committee shall also refer the matter to the Aquatics Integrity Unit if they consider that consequences beyond the tournament should be considered. For the sake of clarity, the Management Committee is entitled to review official video of any match of the tournament to decide whether the player or coach shall be excluded from other games in the tournament, regardless of whether or not the offense was sanctioned by the referee during the match.

If a team official is suspended from a specific match, the team shall have the number of team officials on the bench reduced accordingly; provided that there is at least one (1) team official on the bench.

If a player is suspended from a specific match, the team can have 13 players for the next game(s), provided that they are registered at the team list for the specific World Aquatics event and they don't have any suspension at that moment.

17. ACCIDENT, INJURY AND ILLNESS

17.1 A player shall only be allowed to leave the water, or sit or stand on the steps or side of the pool during play in the case of accident, injury, illness or with the permission of a referee. A

player who has left the water legitimately may re-enter from the team's exclusion re-entry area at an appropriate stoppage, with the permission of a referee.

17.2 If a player is bleeding, the referee shall immediately order the player out of the water with the immediate entry of a substitute and the game shall continue without interruption. After the bleeding has stopped, the player is permitted to be a substitute in the ordinary course of the game.

17.3 If accident, injury or illness, other than bleeding, occurs, a referee, at the referee's discretion, may suspend the game for not more than three minutes, in which case the referee shall instruct the timekeeper as to when the stoppage period is to commence.

17.4 Should the game be stopped through accident, injury, illness, bleeding or other unforeseen reason, the team in possession of the ball at the time of the stoppage shall put the ball into play at the place of stoppage when the play is resumed.

17.5 Except in the circumstances of VI.17.2 (bleeding), the player shall not be allowed to take further part in the game if a substitute has entered.

17.6 If the referee or VAR assistant referee or delegate, suspects that a violent action may have occurred, the referees may review VAR according to the VAR protocol. (Appendix 7).

17.7 Medical and Safety specific requirements for Water Polo

Water Polo is a contact sport. The incidence of traumatic injuries is the highest of the World Aquatics Sport. Therefore, the Medical Team shall be ready to address some specific issues.

17.7.1 Traumatic Injury

Contact injuries in water polo are high. Therefore, the Chief Medical Officer (CMO) or Venue Medical Officer (VMO) should have the proper medical kit to manage traumatic injuries, which should include suture material and/or skin glue, as a bleeding athlete will not be allowed back in the water (VI.17.2).

In addition, ice packs should be available during matches.

Lifeguards and the FoP medical team should be trained in trauma

recognition and deep water extractions.

17.7.2 Dental program

While a dental program is not mandatory at World Aquatics Events, the availability of such medical service should be considered by LOC for major competitions.

The objective of a dental program is:

- to provide the treatment required to allow an athlete with an oro-facial injury to return to play as soon as is safe to do so, or
- to treat and stabilise the injury prior to referral.

If there is no venue dentist, a dentist should be identified to be 'on call' for emergency access during the Event.

17.7.3 Water Rescue and Lifeguards

Lifeguards should practice water retrieval on a daily basis during the event. In Water Polo, it is important to remember that the Field of Play is divided by the lane ropes that could block the access to the player during the water rescue. This point must be taken into consideration while practicing and the extraction point should be adjusted.

18. WATER POLO FACILITIES

18.1 General Requirements

18.1.1 Water Polo Dimensions and Equipment as detailed in Field of Play diagram. See Water Polo Diagram 1

18.1.2 The overall Field of Play will be 30.60m x 20.00m for men and 25.60m x 20.00m for women.

The distance between the goal lines shall not be less than 20.00 metres and not more than 30.00 metres for games played by men. The distance between the goal lines shall not be less than 20.00 metres and not more than 25.00 metres for games played by women.

The anchor point at the edge of the Field of Play shall be placed 30cm behind the front of the goal line.

The width of the Field of Play shall be not less than 10 metres and not more than 20.00 metres.

Exception from this rule may be allowed on the discretion of the federation controlling the match.

18.1.3 The depth of the water shall be consistently not less than 1.80 metres.

18.1.4 The water temperature shall be 26° plus 1° minus 1° Centigrade (25°C-27°C).

18.1.5 The light intensity shall not be less than 600 lux.

18.1.6 Minimum Ceiling height is not required.

18.1.7 Lane Ropes

Each lane rope will have a minimum diameter of 0,06 metres and a maximum diameter of 0.12 metres.

Lane rope should be secured at each wall to anchor brackets recessed into the walls. If anchor placement is on pool deck, an extender, firm and non-elastic, should be in place. The installed lane rope should stay in the pool water. The anchor, including extender, shall not extend more than 10mm into the pool. The anchor shall not influence the length of the lane rope by more than ± 10mm each end of rope. Anchors should be installed to withstand 20kN. The lane rope shall be equipped with a tension spring, absorbing sudden high point loads and a wire withstanding a tensile force of 12kN.

18.1.8 Flying Substitution Area

An area for flying substitutions must be available on the lateral outer side of the field of play, on the side where the team benches are situated. The width of this area shall be not less than 0.50 metres.

The designated area for flying substitutions for each team will be between the goal line in front of the team bench and the centre of the field of play.

18.2 Water Polo facilities for Olympic Games and World Championships

18.2.1 General Requirements

Water Polo Dimensions and Equipment as detailed in Field of Play diagram

for Olympic Games and World Championships. *See Water Polo Diagram, Appendix 2*

18.2.2 Field of play

The overall Field of Play will be 30.60m x 20.00m for men and 25.60m x 20.00m for women.

The distance between respective goal lines shall be 30.00 metres for games played by men and 25.00 metres for games played by women.

The anchor point at the edge of the Field of Play shall be placed 30cm behind the front of the goal line. The width of the Field of Play shall be 20.00 metres.

Exceptions from the requirements in 11.16.3.2.2 are not allowed.

18.2.3 The depth of the water shall be consistently not less than 2.00 metres.

18.2.4 The water temperature shall be 26° plus 1° minus 1° Centigrade (25°C-27°C).

18.2.5 The light intensity shall not be less than 1500 lux.

18.2.6 In indoor swimming pools the minimum height of the Field of Play shall be not less than 7.00 meter.

18.2.7 Lane Ropes

Each lane rope will have a diameter of 0,10 metres.

Lane rope should be secured at each wall to anchor brackets recessed into the walls. If anchor placement is on pool deck, an extender, firm and non-elastic, should be in place. The installed lane rope should stay in the pool water. The anchor, including extender, shall not extend more than 10mm into the pool. The anchor shall not influence the length of the lane rope by more than ± 10mm each end of rope.

Anchors should be installed to withstand 20kN. The lane rope shall be equipped with a tension spring, absorbing sudden high point loads and a wire withstanding a tensile force of 12kN.

18.2.8 Flying Substitution Area

In indoor swimming pools the minimum height of the Field of Play shall be not less than 7.00 meter.

18.2.9 Salinity of the water

An area for flying substitutions must be available on the lateral outer side of the field of play, on the side where the team benches are situated. The width of this area shall be not less than 0.50 metres.

The designated area for flying substitutions for each team will be between the goal line in front of the team bench and the centre of the field of play.

18.3 Equipment for Water Polo facilities

18.3.1 Markings

Distinctive marks shall be provided on both sides of the field of play to denote the goal lines, lines 2.0 metres and 6.0 metres from that line and half the distance between the goal lines. These markings shall be clearly visible throughout the game.

The white marker shall be measured from the anchor point and will be 0.3 metres to line up with the front of the edge of the goal line. This shall be consistent at both ends of the field.

The 2 metre red marker shall be measured from the front end of the goal line extending into the field of play. This shall be consistent at both ends of the field of play.

The yellow marker shall then extend 4 metre from the 2 metre marker into the field of play. There will be a red marker placed 5 metre from the front end of the goal line. This shall be consistent at both ends of the field of play.

The middle section of the field of play will be green and should be 18 metre for the men's game and 13 metre for the women's game. There will be a white marker placed in the middle of the green area to denote the centre of the field.

The exclusion zones shall be placed in the two corners on the opposite side of the pool to the official table. They shall be 2 metre in length and shall extend along the goal line.

18.3.2 Referee platforms

Platforms must be provided on both sides of the field of play, which shall be 1 metre in width and 70 cm in height above the water level. These platforms enable the referees to have free way from end to end of the field of play. Sufficient space shall also be provided at the goal lines for the Goal Judges.

The platforms must be colour coded to meet the specification as shown in the diagram of the field of play. *See Water Polo Diagram, Appendix 2*

18.3.3 Goals

The goal posts and crossbar must be of wood, metal or synthetic (plastic) with rectangular sections of 80,0 millimetres, square with the goal line and painted white.

The goal posts must be fixed, rigid and perpendicular at each end of the playing space, equal distances from the sides and at least 0.3 metre in front of the ends of the field of play or of any obstruction. Any standing or resting place for the goalkeeper other than the floor of the pool is not permitted.

The inner sides of the goal posts must be 3.0 metre apart.

The underside of the cross bar must be 0.9 metre above the water surface.

18.3.4 Re-entry area

The rectangular excluded players' re-entry area shall have the following dimensions: 2.0 metres by 1.08 metre.

18.3.5 Nets

Limp nets must be attached to the goal fixtures to enclose the entire goal space securely fastened to the goal posts and crossbar, allowing not less than 0.3m of clear space behind the goal line everywhere within the goal area.

18.3.6 Secretariat table

The game secretariat shall be placed at a table behind the referees and at the same.

19. BEACH WATER POLO RULES

19.1 FIELD OF PLAY

19.1.1 The distance between the goal line at each end of the field of play shall be fifteen (15) metres. The width of field of play shall be 10.0 – 12.5 metres.

19.1.2 The depth of the water of the playing area must not be less

than two (2) metres.

19.1.3 Distinctive buoys shall be provided on both sides of the playing area:

Two (2) metre area red buoys.

Five (5) metre area yellow buoys remainder of the playing area green buoys.

Half distance line white buoys.

19.1.4 Red buoys shall be placed at each end, two (2) metres from the corner of the playing area on the side of opposite to the official table to denote the touching corner.

19.1.5 The boundary of the field of play at each end shall be in line with the front of the goalpost.

19.1.6 The secretary shall be provided with separate white, blue, red, and yellow flags, each measuring 0.35 metres x 0.20 metres.

19.1.7 An area for flying substitutions must be available on the lateral outer side of the field of play, on the side where the team benches are situated. The width of this area, if segregated by lane ropes, must be between 0.5 metres – 1 metre. The designated area for flying substitutions for each team will be between the goal line in front of the team bench and the centre of the field of play.

19.1.8 The BWP Goal Area is defined by the space between the goal posts, extending out to the 2-metre line. (See rules 19.16.1, 19.17.3h and 19.19.2).

19.2 GOALPOSTS

19.2.1 Two goalposts and crossbar rigidly constructed, rectangular with a dimension of 0.080 metres facing to the field of play and painted in any colour. The goals shall be located on the goal lines at each of the field of play end and equal distances from the sides. While rigidly constructed posts are preferred for World Aquatics events, inflatable posts are allowed for local tournaments.

19.2.2 The inner sides of the goal posts shall be 2.5 metres and the crossbar shall be 0.80 metres from the surface of the water.

19.2.3 The limp nets shall be securely fastened to the goal posts to prevent the ball from going underneath or through the side of net.

The depth of the goals shall not be less than 0.30 metres.

19.3 THE BALL

19.3.1 The ball shall be round and shall have an air chamber with a self-closing valve. It shall be waterproof without external strapping or any covering of grease or similar substance.

19.3.2 The weight of the ball shall be not less than 400 grammes and not more than 450 grammes.

19.3.3 For the games played by men, the circumference of the ball shall be not less than 0.68 metres and not more than 0.71 metres, and its pressure shall be 7.5-8.5 pounds per square inch atmospheric.

19.3.4 For games play by women, the circumference of the ball shall be not less than 0.65 metres and not more than 0.67 metres, and pressure shall be 6.5-7.5 pounds per square inch atmospheric.

19.4 CAPS

19.4.1 Caps shall be of contrasting colours other than solid red, as approved by the referee, but also to contrast with the colour of the ball. A team may be required by the referee to wear white or blue caps. The goalkeepers shall wear red caps. Caps shall be fastened under the chin. Caps shall be fitted with malleable ear protectors which shall be the same colour as the team's caps except that the goalkeeper may have red ear protectors.

19.4.2 Caps shall be numbered on both sides with 0.10 metres in height. The goalkeeper shall wear cap number one (1) and the other caps shall be numbered two (2) to seven (7).

19.4.3 A player who substitutes for the goalkeeper shall wear a red cap with the same number as he/she was wearing as a field player. A player shall not be allowed to change cap number during the game except with the permission of the referee and after notifying the secretary. Caps shall be worn throughout the entire game. If a player loses the cap during play, the player shall replace it at the next appropriate stoppage of the game when the player's team is in possession of the ball. The substituted goalkeeper shall wear cap No.1 with the same colour of his/her team. Teams shall supply a set of red caps numbered 1-7, as well as a cap numbered one (1) in the

same colour of his/her team.

19.4.4 For international games, the caps shall display the international three letter country code on the front and may display the national flag.

19.5 TEAMS AND SUBSTITUTES

19.5.1 Each team shall consist of four players, one of whom shall be the goalkeeper, and not more than three reserves who may be used as substitutes.

19.5.2 Two (2) officials namely the head coach or another official (Assistant Coach or Team Manager) are permitted to sit on the pontoon or similar designated area and shall not move away from there during the game. Up to two (2) other medical staff are permitted at a separate location away from the team bench.

19.5.3 Teams shall change ends at half time.

19.5.4 The substitutes' benches in beach water polo can be a pontoon and must be placed on the opposite side of the field of play from the referee and match officials.

19.5.5 Each team shall have a captain who shall be responsible for the behaviour of the team.

19.5.6 Players have to present themselves for matches with fingernails properly cut and shall remove any articles that are likely to cause injury.

Players shall not have grease, oil or any similar or foreign substance on the body or hands. If the referee ascertains before the start of play that such a substance has been used, they shall order it to be removed immediately. If the offence is detected after the play has started, the offending player shall be excluded for remainder of the game with immediate substitution.

19.5.7 Each team shall have three substitutes who may participate in the game substituting a player. A substitute may enter the game from the touching corner as soon as the exiting player has visibly risen to the surface of the water in the touching corner and touched hands above the water with the substitute outside of the field of play. Substitution from the designated flying substitution area is allowed when the substitute enters the area from behind the

extended goal line, both players, the exiting player, and the substitute, are in the water, outside of the field of play and touch hands above the water.

19.5.8 A goalkeeper who has been replaced by a substitute may play in any position.

19.5.9 After a goal, substitutions may be made from either the touching corner or flying substitution area after the goalkeeper has put the ball back into play. When substituting, both players need to be outside the field of play and make a visible high hand touch between the substituting players before entering the field of play.

19.5.10 The goalkeeper may touch the ball with two (2) hands inside the team's five (5) metre area.

19.5.11 No substitution is allowed when a penalty foul is called, and before the penalty throw is taken.

19.6 OFFICIALS

19.6.1 In all official competitions the match officials shall be as follows:

- one referee
- two secretaries
- two timekeepers

19.6.2 The duties of the secretaries shall be:

- to maintain the record of the game, including the players, the score, time outs, exclusion fouls and penalty fouls awarded against each player.
- to signal with the red flag and whistle for any improper re-entry of an excluded player or substitute.
- after three (3) minutes, the secretary should signal the re-entry of a substitute for a player who has committed brutality by raising the yellow flag along with the appropriate coloured flag.
- to keep track of personal fouls, team fouls, and to indicate when a bonus penalty foul is called by a suitable audible signal (e.g., whistle or electronic signal). To record the time and the player's cap number when a goalkeeper is substituted.
- to control the 'Alternating Possession System' for awarding free throws for neutral throw situations. (19.15.1).

19.6.3 The duties of the timekeeper shall be:

- to record the exact periods of actual play, time outs and the intervals between the periods.
- to record the periods of continuous possession of the ball by each team.

- to announce the start of the last minute of the game.
- to signal by whistle after 45 seconds and at the end of each time out.
 - 19.6.4** A timekeeper shall signal by whistling (acoustically efficient and readily understood) the end of each period independently of the referee and the signal shall take immediate effect and stop the game except:
- in the case of the simultaneous award by the referee of a penalty throw, in which event the penalty throw shall be taken.
- if the ball is in flight and crosses the goal line, in which event any resulting goal shall be allowed.

19.7 REFEREE

19.7.1 The referee has absolute jurisdiction over the game, from the time the teams enter the playing area until they leave. All decisions are final and have to be accepted by all players and coaches. The referee may alter a decision, as long as this is done before the ball is back in play.

19.7.2 The referee shall whistle to start the game and to declare goals, goal throws, corner throws, neutral throws, and infringements of the rules.

19.7.3 The referee can apply the advantage rule so as not to favour the team that has committed the offence and should not stop play unless it is absolutely necessary.

19.7.4 The referee has the power to order any player from the water in accordance with the rules. If a player refuses to obey the referee's instructions, the match shall be abandoned and the game awarded five (5) goals to zero (0) to the opposing team.

19.7.5 The referee shall have the power to order the removal from the precincts of the pool any player, substitute, spectator or official whose behaviour prevents the referee from carrying out their duties in an impartial manner.

19.7.6 The referee shall have the power to abandon the game at any time if the referee believes that behaviour of players or spectators, or any other circumstances, prevent the match from taking place in a fair and correct manner. If the game has to be abandoned, the referee shall report their actions to the competent authority.

19.8 DURATION OF THE GAME

19.8.1 The duration of the game shall be four (4) periods of five (5) minutes each of actual play. Time shall commence at the start of each period when a player touches the ball. At all signals for stoppages, the recording watch shall be stopped until the ball is put back into play by the ball leaving the hand of the player taking the appropriate throw or when the ball is touched by a player following a neutral throw.

19.8.2 There shall be a two (2) minute interval between the 1st/2nd & 3rd/4th periods, and a three (3) minute interval at half time. The teams, including the players, coaches and officials, shall change ends at half time (VI.19.5.3).

19.8.3 Every game that is drawn at the end of the four periods of play will be decided by conducting a penalty shoot-out in the same manner as the Water Polo Rules. The goalkeeper can be one of the shooters. The goalkeeper can be substituted only when the goalkeeper is excluded for the remainder of the game for misconduct, violent action, or injury. Immediately after the goalkeeper is excluded, the substitute goalkeeper cannot have the goalkeeper's privileges for the first penalty throw taken after the offence.

The three players nominated will required to be listed in order and that order will determine the sequence, which cannot be changed.

No players excluded for remainder of the game are eligible to be listed among those players to shoot.

Shots will be taken alternately at either end of the pool, unless conditions at one end of the field of play advantage or disadvantage a team, in which case all shots may be taken at the same end. All players taking the shots will remain in the water in front of their pontoon and the other players will be required to be seated on the team's pontoon. If the goalkeeper is excluded during the penalty shoot-out, a player from the nominated three players may substitute for the goalkeeper but without the privileges of the goalkeeper.

Following the taking of the penalty shot, the player may be substituted by another player or goalkeeper. If a field player is excluded during the penalty

shoot-out, the player's position is removed from the list of the three players participating in the penalty shoot-out, and a substitute player is placed in the last position of the list.

The team to shoot first will be determined by the toss of a coin.

should teams still be tied following the completion of the initial three penalty shots, the same three players shall then take alternate shots until one team misses and the other scores.

19.8.4 Any visible clock shall show the time in descending manner.

19.8.5 If a game (or part of a game) must be replayed, then goals, personal fouls and time outs that occurred during the time to be replayed are deleted from the game score sheet, however brutality, misconduct, and any red card exclusions are recorded on the game score sheet.

19.8.6 (Mercy Rule) After half time, if the goal difference between the two team is 10 or more, the game will be declared finished and the leading team the winner.

19.9 TIME OUTS

19.9.1 Each team may request two timeouts per game.

19.9.2 A time out may be requested at any time by the coach of the team in possession of the ball except when a penalty foul is called. The coach shall call "time out" and signal to the referee or secretary with hands forming a T- shape. If a time out is requested, the secretary or referee shall immediately stop the game by whistle and players shall return to their respective halves of the field of play.

19.9.3 Play shall be restarted upon the whistle of the referee by the team in possession of the ball putting the ball into play on or behind the half distance line.

The possession clock continues from the recommencement of play after the time out.

19.9.4 If the coach in the possession of the ball requests an additional time out to which the team is not entitled, the game shall be stopped and play shall then be restarted by a player of opposing team putting the ball into play at the half distance line.

If the coach of the team not in possession of the ball requests a time out, the game shall be stopped and a penalty throw awarded to the opposing team.

19.10 THE START OF PLAY

19.10.1 The first team listed in the official program will wear white or light colour caps, or the caps reflecting the colour of their country and will start the game to the left of the official table. The other team will wear blue or dark colour caps, or caps of a contrasting colour and will start the game to the right of the official table.

19.10.2 At the start of each period, both teams will line up on their side of the playing area. When the referee is satisfied both teams are ready the referee shall blow the whistle to start and then throw the ball into play on the half distance line.

19.10.3 If the ball is thrown giving one team a definite advantage, the referee shall call for the ball and award a neutral throw on the half distance line.

19.11 SCORING

19.11.1 A goal shall be scored when the entire ball has passed fully over the goal line, between the goal posts and underneath the crossbar.

19.11.2 A goal can be scored with any part of the body except the clenched fist.

19.11.3 A goal can be scored from inside five (5) metres only if two players from either team intentionally play or touch the ball after the start of play.

19.11.4 A goal may be scored by a player by a shot from a free throw awarded and taken outside the five (5) metre area after fake or dribble or putting the ball on the water.

[Note: when the player is not shooting directly, the ball must be put in play as described in the rules before faking and dribbling]

19.11.5 A goal may be scored by a player after visibly putting the

ball in play outside of five (5) metre line when the foul is called outside of five (5) metre line, goal throw (either directly or after putting the ball in play), or a free throw thrown by a player into the player's own goal.

19.11.6 A goal shall be scored if, at the expiration of twenty (20) seconds possession or at the end of a period, the ball is in flight and enters the goal.

19.12 RESTARTING AFTER A GOAL

19.12.1 The goalkeeper shall put the ball into play from the two (2) metre line or behind immediately after a goal has been scored. The timekeeper shall stop the game clock after a goal is scored, and will restart it when the ball is put into play for restart.

19.13 GOAL THROW

19.13.1 A goal throw shall be awarded when the entire ball has passed fully over the goal line excluding between the goal posts and underneath the crossbar, having last been touched by any player.

19.13.2 The goal throw shall be taken by any player of the team from anywhere within the 2metre area.

19.14 CORNER THROW

19.14.1 No corner throws shall be applied in Beach Water Polo.

19.15 NEUTRAL THROW

No neutral throws shall be taken, and if neutral throw situation occurs, "The Alternating Possession System" shall be applied in the following way:

The team that wins the swim-up of the first period loses the first neutral throw.

For subsequent neutral throw situations, free throws shall be awarded to the teams alternately. The team entitled to the next free throw shall be indicated by the alternating possession arrow in the direction of the opponent's goal.

The direction of the alternating possession arrow shall be reversed immediately when the alternating possession free throw is taken.

19.16 FREE THROW

19.16.1 A free throw shall indicate that a foul has been committed. The free throw shall be taken from the location of the ball, except a) if the foul is committed by a defending player within the defender's BWP Goal Area, the free throw shall be taken on the two (2) metre line opposite to where the foul was committed and b) where otherwise provided for in the Rules.

19.16.2 The free throw shall be taken from the location of the ball by the player of the team who is the nearest to the ball. When there is a counter attack, a player with advantage does not have to give up the advantage to go to the ball and take the free throw or goal throw. Another player of that team can take the throw as long as there is no undue delay.

19.16.3 The free throw must be taken in such a manner so as to enable all the other players to see that the throw has been taken. The player can either throw the ball up into the air or let it fall on to the water.

19.16.4 The time allowed for a player to take a free throw shall be at the discretion of the referee. It shall be reasonable and without undue delay but does not have to be immediate. It shall be an offence if a player who is clearly in a position most readily to take a free throw does not do so.

19.17 ORDINARY FOULS

19.17.1 The penalty for an ordinary foul shall be a free throw awarded to the opposing team.

19.17.2 The referee must award ordinary fouls in accordance with the rules to enable the attacking team to develop an advantage situation.

19.17.3 It shall be an ordinary foul to commit any of the following offences:

a) to start the swim off before the referee's whistle is blown;

- b)** to assist or push a player at the start of a period or at any time during the game;
- c)** to hold on or push off equipment or structures around the field of play or the goal posts;
- d)** To take or hold the entire ball under the water when tackled, or to deliberately hide it from the opposing team
- e)** to touch the ball with two hands at the same time, except for the goalkeeper within the team's own five (5) metre area;
- f)** to push or push off from an opponent who is not holding the ball;
- g)** for another member of the team in whose favor a free throw has been awarded to commit another ordinary foul before the free throw is taken;
- h)** during the game, players are free to take up any position in the field of play with the exception that no attacking player may enter the space between the goal posts and closer than two (2) metres from the goal line, with or without the ball (the BWP Goal Area).
- i)** to take a penalty throw not in accordance with the manner prescribed in 19.20.5.
- j)** to send the ball over the buoys delineating the sides of the field of play (the ball remains in play if it just touches the sides of the field of play);
- k)** for a goalkeeper to touch the ball with two hands at the same time outside the goalkeeper's five (5) metre area;
- l)** for a team to retain possession of the ball for more than twenty (20) seconds of actual play without shooting at their opponent's goal. The timekeeper recording the possession time shall reset the clock: when the ball has left the hand of the player shooting at goal. If the ball rebounds into play from the goal, crossbar or the goalkeeper, the possession time shall not:
 - m)** recommence until the ball comes into the possession of one of the teams;
 - n)** when the ball comes into the possession of the opposing team. Possession shall not include merely being touched in flight by an

opposing player;

o) when the ball is put into play following the award of an exclusion foul, penalty foul, goal throw, corner throw or neutral throw:

p) Visible clocks shall show the time in a descending manner (show the possession time remaining).

q) To simulate being fouled. [NOTE: Simulation means an action taken by a player with the apparent intent of causing a referee to award a foul incorrectly against an opposing player. A referee may issue a yellow card against a team for repeated simulation and may apply VI.9.13 (persistent fouling) to sanction offending players.]

r) To go under the water to gain positional advantage.

19.18 EXCLUSION FOULS

19.18.1 It shall be an exclusion foul to commit any of the following offences which shall be punished (except in the case of penalty throw) by the award of a free throw to the opposing team. The excluded player shall touch that part of the goal line indicated by red buoy and re-join play immediately. A penalty will be awarded against the team of that player who, when leaving the playing area after being excluded, interferes with play. The excluded player may be substituted by leaving the field of play at that part of the goal line indicated by the red buoy (the touching corner). The substitute may enter the field of play from the touching corner as soon as the player has visibly risen to the surface of the water within the touching corner area and touched hands above the water with the substitute.

19.18.2 For a player to leave the water during play, except in the case of accident, and injury, or with the permission of the referee.

19.18.3 To interfere with the taking of a free throw or goal throw intentionally pushing the ball away to delay the throw any attempt to play the ball before it leaves the hand of the player taking the throw.

19.18.4 To intentionally splash water in the face of an opponent outside the five (5) metre line. The punishment for intentionally

splashing an opponent is exclusion under 19.18.1

19.18.5 To hold, sink or pull back an opponent who is not holding the ball.

19.18.6 To impede an opponent's movement who is not in possession of the ball.

19.18.7 To kick or strike an opponent intentionally or make disproportionate movement with that intent.

19.18.8 Upon a change of possession, for a defending player to commit a foul on any player of the team in possession of the ball with the intent to stop the flow of the attack, anywhere in the field of play. This kind of foul is called a tactical foul.

19.18.9 To be guilty of misconduct, including the use of unacceptable language, violent or persistent foul play, to refuse obedience or show disrespect to the referee or official, or behaviour against the spirit of the rules and likely to bring the game into disrepute. While substitution for a player who has been excluded for the remainder of the game due to misconduct can be made immediately in BWP rules, the player who has been excluded for the remainder of the game due to misconduct will have to leave the field of play from the touching corner first, and then the substitute can enter the field of play immediately thereafter.

19.18.10 To commit a violent action against an opponent or official, during the game. The offending player shall be excluded from the remainder of the game with substitution after three (3) minutes and a penalty throw awarded to the opposing team.

No penalty throw shall be awarded against a violent action committed during an interval or stoppage.

19.18.11 For an excluded player to re-enter or a substitute to enter the playing area improperly, including: from any place other than the player's own re-entry area by affecting the alignment of the goal entering the field of play before the player who is being substituted leaves the field of play

19.18.12 To interfere with the taking of a penalty throw, in which case the player excluded can only re-enter the field of play after the penalty throw has been taken. Players have to be at least three (3)

metres away from the player taking the penalty throw.

19.18.13 The defending goalkeeper, after having been warned by the referee, for not positioning correctly on the goal line before the taking of a penalty throw. Another defending player may take the position of the goalkeeper but without the privileges of the goalkeeper.

A goalkeeper who is excluded before a penalty throw, cannot return to the field of play immediately after touching the corner area, but has to leave the field of play and wait in the touching corner. The goalkeeper shall be able to return to play only after the penalty shot has been taken, which means the ball is released from the thrower's hand.

19.18.14 If two players from opposing sides commit simultaneous exclusion fouls, both players will be excluded. The ball possession will be maintained, and the attacking team shall restart the game with a free throw. Possession time shall be maintained and shall not be reset.

The game will restart when both of the excluded players have returned to their touching corners. Both players or substitutes will then be allowed to return to the field of play upon a change of the possession, or after a goal. If the excluded players are substituted, substitutions have to be made outside of field of play at the touching corner after touching hands with the both players.

19.18.15 A player who has committed five (5) personal fouls shall be excluded for the remainder of the game.

19.19 PENALTY FOULS

19.19.1 It shall be a penalty foul to commit any of the following offences which shall be punished by award of a penalty throw to the opposing team. The referee will indicate that a penalty throw has been awarded by blowing the whistle and raising the arm with five fingers. The referee must delay the call of penalty until the shot or attempted shot is completed. In such case, the referee may raise his/her arm indicating a possible penalty.

19.19.2 For a defending player to commit any foul within the five (5) metre area but for which a goal would probably have resulted, including: sink or displace the goals for a defending player to play

the ball with clenched fist for the goalkeeper or another player to take the ball under the water when tackled within 5m area but outside the BWP Goal Area to splash in the face of an opponent intentionally who is inside the five (5) metre area and is attempting to shoot at goal.

19.19.3 For a defending player within the 5-metre area to kick or strike an opponent or to commit a violent action. In the case of a violent action, the offending player shall also be excluded from the remainder of the game with substitution after three (3) minutes.

19.19.4 For an excluded player intentionally to interfere with play, including affecting the alignment of the goal.

19.19.5 For a player or substitute who is not entitled under the Rules to participate in the play at that time to enter the field of play. The offending player shall also be excluded from the remainder of the game with substitution.

19.19.6 For the coach, any team official, or player to take any action with intent to prevent a probable goal or to delay the game, including:

- If a defending player deliberately throws the ball away before the attacking team can take a free throw
- If a defending player, after a free throw outside the five (5) metre line, deliberately pushes the ball inside five (5) metre line, to avoid a direct shot.

No personal foul shall be recorded for this offence for the coach or any team official.

19.19.7 For a player or substitute, of the team not in possession of the ball, to enter the field of play improperly.

19.19.8 If, in the last minute of the game a penalty throw is awarded to a team, the coach may elect to maintain possession of the ball and be awarded a free throw. The timekeeper recording possession time shall reset the clock.

19.19.9 Inside the 5 metre area, when a player, in a “probable goal situation”, is swimming with and/or is holding the ball and is impeded (attacked) from behind during an attempt to shoot, a penalty foul must be awarded. [Note: unless only the ball is touched by the defender]

19.19.10 Bonus penalty throws shall be awarded at every 4th personal foul (Team Fouls) per period. At the fourth personal foul per team in a period, a bonus penalty throw shall be awarded to the other team, and the player who has committed the foul shall move to touching corner of the player's team outside the field of play until the penalty throw is taken. In this case, no substitution shall be allowed before the penalty throw is taken. If the 4th personal foul is a penalty foul, only 1 penalty throw shall be awarded to the other team. If the penalty throw results in a goal, the team who has taken the penalty throw shall be allowed to have a new consecutive possession of the ball starting in the same manner as restart after a timeout (19.9.3). If the penalty throw does not result in a goal, the play shall continue.

19.20 PENALTY THROWS

19.20.1 A penalty throw can be taken by any player of the team in favour of which the throw has been awarded. The penalty throw is taken from the five (5) metre line.

19.20.2 The defending goalkeeper shall be positioned between the goalposts with no part of the body beyond the goal line at water level.

19.20.3 All players except the player who has committed the penalty foul shall leave the five (5) metre area and shall be at least three (3) metres from the player taking the penalty throw. A player who has committed a penalty foul shall move to their team's touching corner inside of the field of play until the penalty throw is taken.

19.20.4 The referee, after seeing that all the players are in correct position, will order the taking of the penalty throw in the following manner: The raised arm will mean ready to shoot and by bringing the referee's arm from vertical to horizontal position and blowing the whistle simultaneously. The lowering of the arm at the same time as the signal by whistle makes it possible under any conditions to execute the penalty throw in accordance with the rules.

19.20.5 The player taking the penalty throw shall have possession of the ball and shall immediately throw it with an uninterrupted

movement directly at the goal. The player may take the throw by lifting the ball from the water or with the ball held in the raised hand and the ball may be taken backwards from the direction of the goal in preparation for the forward throw, provided that the continuity of movement shall not be interrupted before the ball leaves the thrower's hand.

19.20.6 If the ball rebounds from the goalpost crossbar or goalkeeper, it remains in play and it shall not be necessary for another player to play or touch the ball before a goal can be scored.

19.20.7 If, at precisely the same time as the referee awards a penalty throw, the timekeeper whistles for the end of a period, all players except the player taking the penalty throw and the defending goalkeeper shall leave the water before the penalty throw is taken. In this situation, the ball shall immediately be dead should it rebound into the field of play.

19.21 ACCIDENT AND INJURY

19.21.1 A player shall only be allowed to leave the water during play in the case of accident or injury or with the permission of the referee. A player who has left the water legitimately may re-enter from the re-entry area nearest the player's own goal line at an appropriate stoppage and with the permission of the referee.

19.21.2 If a player is bleeding, the referee shall immediately order the player out of the water with the immediate entry of a substitute. After the bleeding has stopped, the player is permitted to be a substitute in the ordinary course of the game.

19.21.3 If accident or injury, other than bleeding, occurs, the referee, at the referee's discretion, may suspend the game for not more than three minutes, in which case the referee shall instruct the timekeeper as to when the stoppage period is to commence. Except in the circumstances of 19.21.2 (bleeding), the player shall not be allowed to take further part in the game if a substitute has entered.

19.22 PERSONAL FOULS

19.22.1 A personal foul shall be recorded against any player who commits an exclusion foul or penalty foul. The referee shall indicate the offending player's cap number to the secretary.

19.22.2 Upon receiving a fifth (5th) personal foul, a player shall be excluded from the remainder of the game with substitution after they reach the touching corner outside of the field of play, having touched hands with each other.

19.22.3 When a team accumulates four (4) personal fouls in any period of a game, a penalty throw shall be awarded, and the accumulated Team Fouls shall then be cancelled and recounted (as stipulated in 19.19.10).

19.23 YELLOW AND RED CARDS

19.23.1 The referee, if necessary, must use Yellow and Red Cards to control the Team Officials and Substitute Players on the Team Bench as well as the players in the water. The use of Yellow and Red Cards applies to all World Aquatics Water Polo Competitions and will be administered as follows;

The issuing of a Yellow Card by the referee is an official warning to the Head Coach of the team.

The subsequent issuing of a Red Card by the referee is the signal that the Head Coach and/or other Team Official(s) and/or player(s) on the bench must leave pool area immediately. Should the actions of the Head Coach require it, the referee may issue a Red Card, without having issued a Yellow Card.

When the Head Coach is excluded from the game, another Team Official may take this position, however without the privileges of the Head Coach. The Team Official is not allowed to stand and move away from the team bench but can ask for a time-out according to the rules. During a time out or after a goal, before the restart of the match the Team Official may move freely along the poolside till the halfway mark to instruct the team.

During the match, when a team member inside the water commits an act of misconduct, the referee must show a Red Card to the player accompanied by the appropriate sanction.

A referee may issue a Yellow Card, if, in the referee's opinion, a player persists in playing in an unsporting manner or engages in simulation. (VI.8.14). The referee shall show a Yellow Card to the offending team and point to the offending player. Should the action continue, the referee will show the player a Red Card visible to both the team and the table as this is deemed to be misconduct. (as per VI.9.13)

Team members committing an act of misconduct will be punished according to VI.9.13 and must leave the pool area immediately.

19. APPENDICES

19.1 The following appendices are incorporated in and form part of these Rules:

APPENDIX 1 AND 2 - Diagrams

APPENDIX 3 – Definitions

APPENDIX 4 – Field of Play and Equipment

APPENDIX 5– Officials

APPENDIX 6– Penalty Shoot Out

APPENDIX 7 – VAR Protocol

APPENDIX 8– Age Group Tournaments

APPENDIX 9– Tournaments Structure

APPENDIX 1 – DIAGRAMS

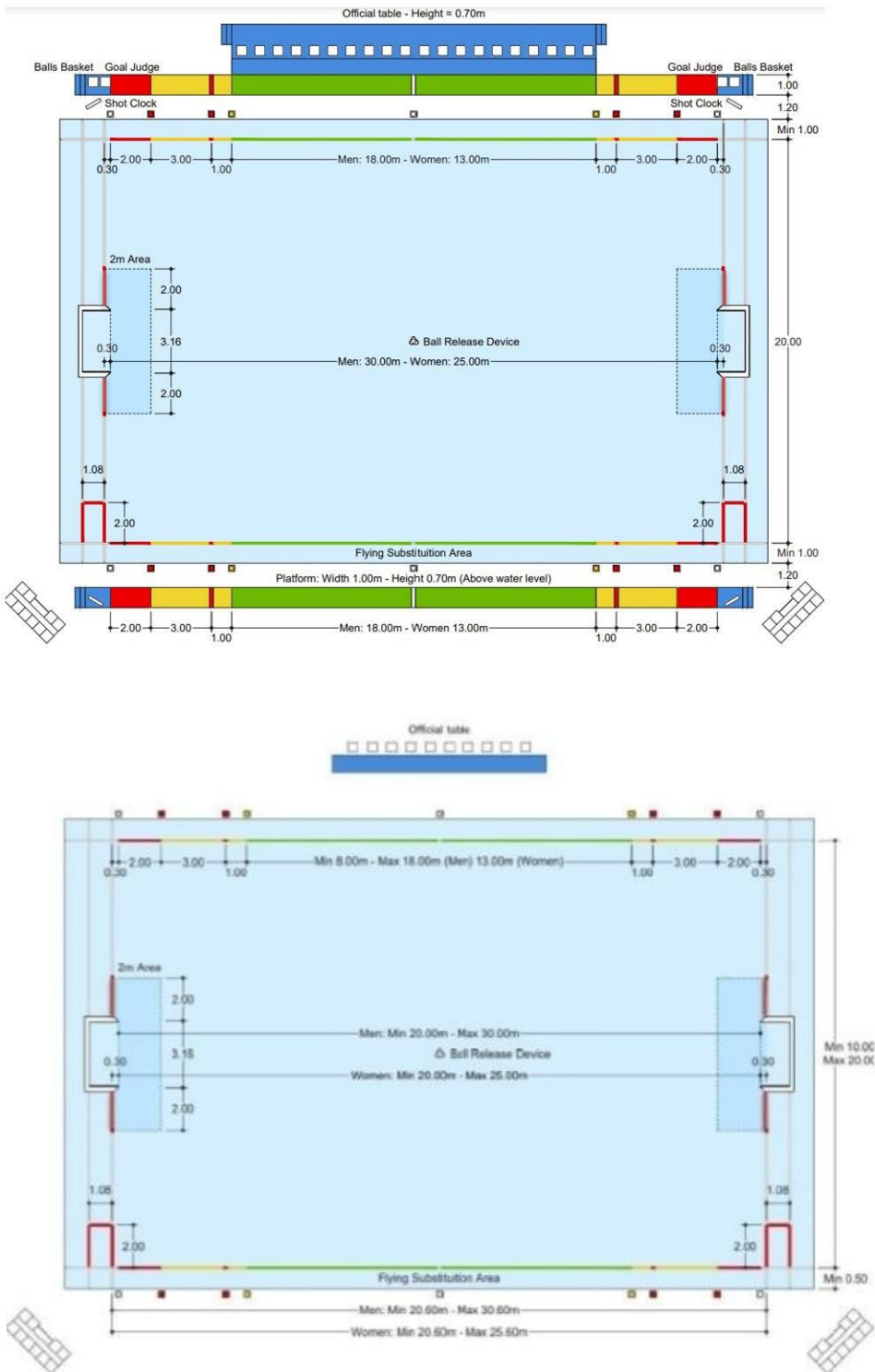

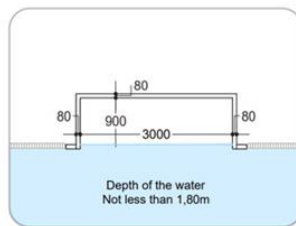
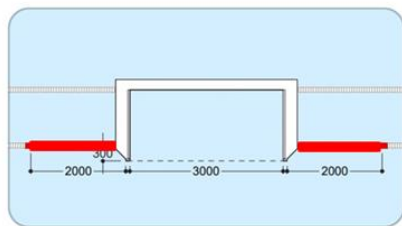
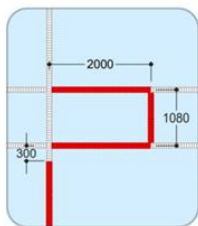

APPENDIX 2 - DIAGRAMS

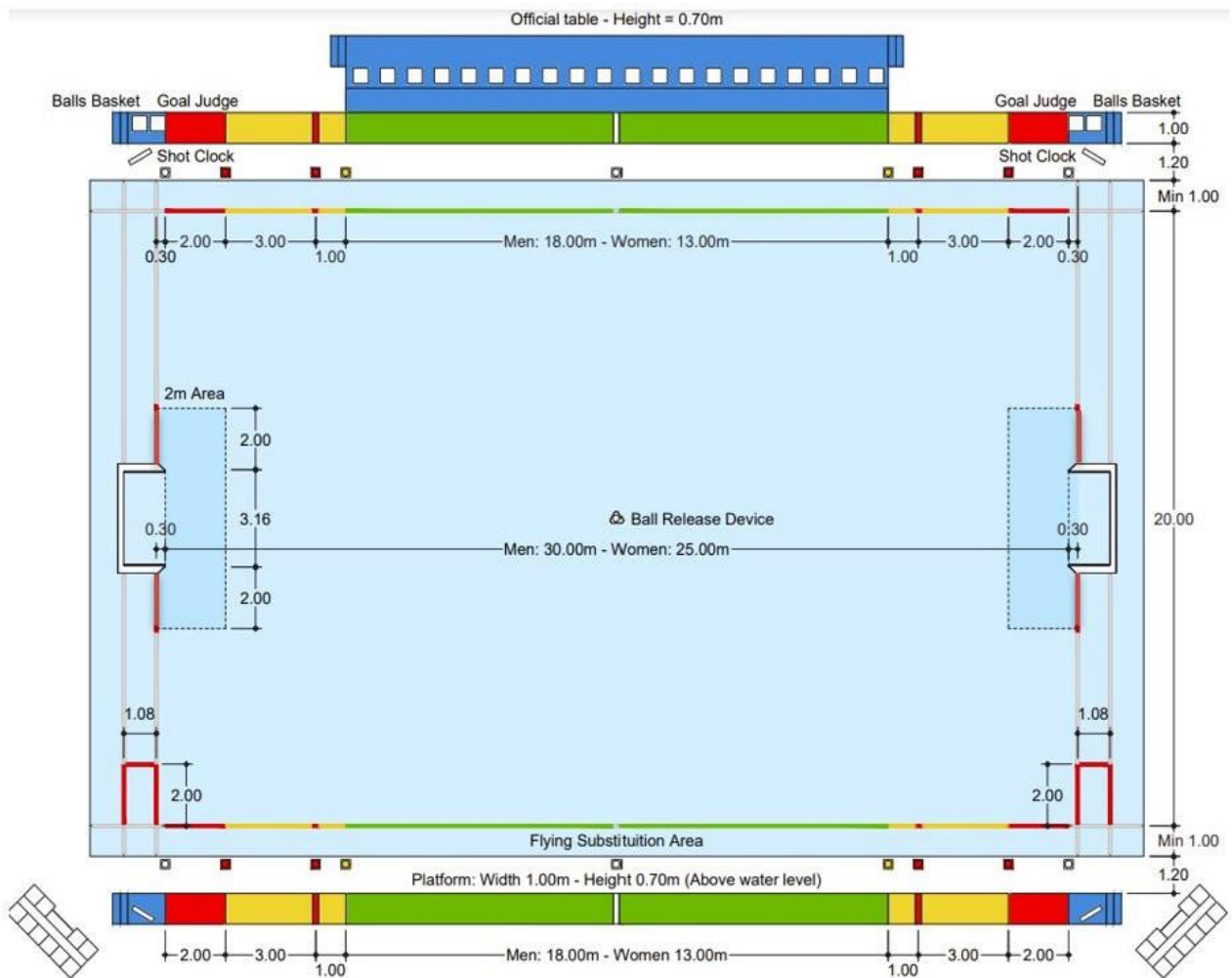
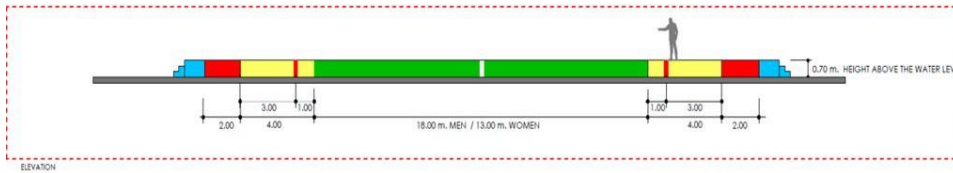
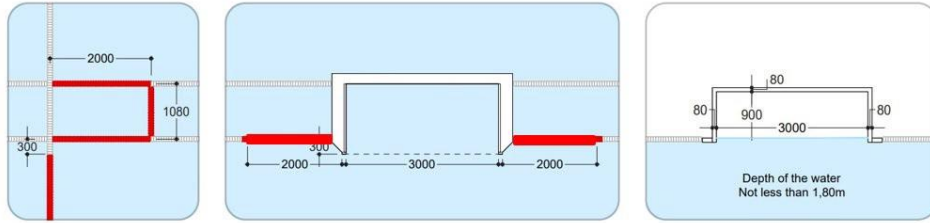

APPENDIX 3 – DEFINITIONS

1. FIELD OF PLAY & EQUIPMENT

1.1. Field of Play: The part of the water officially marked as the place for the action of a water polo game as described in Appendix 4.

1.2. Official table: The designated location where other necessary officials and authorized persons carry out their responsibilities during a game.

1.3. Flying Substitution: The ability of a team to exchange players during play from the flying substitution area.

1.4. Flying Substitution Area: The area designated by the Rules at the side of the Field of Play where flying substitutions may occur.

1.5. Goal (definition A): The result of the ball fully crossing the goal line past the front line of the goal posts and underneath the crossbar.

1.6. Goal line: the end of the field of play, formed by the front face of the goal post (VI 7.1)

1.7. Goal area: Is a rectangular box extending 2 metres from the lateral outsides of the goal posts to the 2 metre line opposite the goal line. In this area, attacking players must not enter without possession of the ball, unless they are behind the line of the ball.

1.8. 5 metre line: Is the line, from where penalty throw should be taken.

1.9. 6 metre area: is an area within 6 metres of the goal line where some fouls according the penalty rules, become a penalty foul.

1.10. Half distance line: Line which divides the length of the field of play into two equal halves at its midpoint.

1.11. Goal: The structure into which the ball must fully enter in order to score. (Appendix 4.2)

2. TEAMS AND SUBSTITUTES

- 2.1. Team:** team of water polo players as described in Section VI
- 2.2. Player:** an individual member of a water polo team.
- 2.3. Goalkeeper:** individual member of a team, wearing a cap 1 or 13, whose main role is to prevent the ball from entering the goal.
- 2.4. Substitute:** A player entering the field to replace a player already in the field of play or an excluded player.
- 2.5. Reserve:** A team member who is not playing at the time.
- 2.6. Designated lateral substitution area:** is “**Area for Flying Substitutions**”
- 2.7. Exclusion Re-entry area:** Location from where a player or substitute returns to the field of play after an exclusion.
- 2.8. Advantage:** The opportunity of an attacking player and/ or the attacking team to continue to play the ball in order to generate an opportunity to score. Referees must officiate such that the attacking team can maintain its advantage.
- 2.9. Red Card:** Signal from the referee to indicate an exclusion from the remainder of the game, to a player, coach or any team official.
- 2.10. Yellow Card:** Warning signal from the referee to the coach for inappropriate behaviour or insufficient bench discipline, or for repeated simulation and persistent foul play of a team.
- 2.11. Offending player:** A player committing a foul according to the rules.

3. REFEREES AND TECHNICAL OFFICIALS

- 3.1. Video assistant referee – VAR:** Video technology and assistant referee, which the referee may use to make a final decision after reviewing a situation in described situations in Appendix 7 - VAR protocol.
- 3.2. Referee:** An official responsible for conducting the game with designated functions fixed by the Rules.

3.3. Possibility to play the ball: When the player in possession of the ball is able to continue playing by putting the ball into action.

3.4. Centre forward: An attacking player whose primary position is near the opponent's 2 metre line and generally between the width of the goal posts.

3.5. Centre back: A defender whose primary responsibility is to mark the attacking centre forward. (See Centre Forward)

3.6. Goal Judge or assistant referee: An official seated on the goal line responsible for assisting the referee in determining if the ball has entered the goal or passed the goal line, including who last touched the ball as well as for throwing a new ball according to the referees' instructions.

3.7. Start or restart: The commencement of play at the beginning of a period, after a goal or after the referee has called for the ball and stopped play.

4. DURATION OF THE GAME

4.1. Actual play: Teams play four periods, each period consisting of eight minutes of actual playing time; a total of 32 minutes. Actual play starts at the beginning of each period, when a player touches the ball, stops on every stoppage indicated by the referee or shot clock and continues after every stoppage when the player puts the ball into play according to the Rules, shoots or passes the ball.

4.2. Penalty Shoot-out: The method of determining a definite result for a game should the scores be level at full time. The method is regulated by Appendix 6.

4.3. Attacking Referee: The referee who is giving primary attention to the attacking situation in front of the goal to the referee's right.

4.4. Defensive Referee: The referee who is controlling the attacking situation to the referee's left. This referee generally maintains a position no closer to the goal being attacked than that player of the attacking team furthest back from the goal.

5. TIMEOUTS

5.1. Timeout: A one-minute stoppage of play available to the attacking team at any time, except at the awarding of a penalty throw or during a VAR review. Each team is entitled to two timeouts per game.

5.2. Illegal Timeout: A requested timeout to which the team is not entitled.

5.3. Possession: Possession of the ball is when a player from one of the teams holding or swimming with the ball.

6. METHOD OF SCORING

6.1. Visibly putting the ball into play: means that the ball must leave the hand of the player with the ball. Throwing the ball from a player's left to right hand is considered putting the ball into play.

6.2. Fake: To simulate a shot.

6.3. Swim up: At the beginning of a period the ball is placed in the middle of the field of play and once the whistle is blown to signal the start of the game, teams sprint towards the middle of the pool to gain possession of the ball.

7. ORDINARY FOULS

7.1. False Start: To begin the start of play improperly, either before the signal from the referee or pushing off from or affecting the alignment of the goal.

7.2. Foul: A violation of a rule resulting in a stoppage of the game clock and the awarding of a free throw. There are two types of fouls:

- Physical fouls (physical contact of a player preventing an opposing player from continuing with movement)
- Technical fouls (against rules, e.g., false start or restart, to strike the ball with clenched fist, two hands, etc.)

7.3. Ball under: Ordinary foul called against a player for taking the ball under water when tackled by an opponent or with intent to hide a ball from an opponent.

7.4. Simultaneous exclusion: When two players from opposing teams are simultaneously excluded.

7.5. Spirit of the Game: Defining characteristic of the sport. Playing within the spirit means playing to win while respecting

teammates, opponents and the game itself. It is defined by understanding the rules and playing with integrity and honesty in mind.

7.6. Push-off: To use the hand, arm, foot or another body part to push off an opponent to gain an advantage.

7.7. Kicking: A blow, strike or forceful thrust with the foot to an opponent's body or face, which is a personal foul.

7.8. Simulation: To pretend to be fouled.

7.9. To drive: An attacking move by a player who is facing an opponent and who attempts to aggressively swim by that player to a position of advantage closer to the goal.

7.10. Driver: A player who is driving towards the goal, usually starting from a stationary position facing an opponent attempting to aggressively swim by the opponent to a position of advantage closer to the goal.

7.11. To tackle: To hold, sink, pull back or impede a player who is holding the ball.

7.12. Half distance line: Line which divides the length of field of play into two equal halves at midpoint of course.

7.13. Offensive Foul: A foul committed by an attacking player resulting in a free throw awarded to the defending team.

7.14. Holding the ball: Lifting, carrying or touching the ball but not including dribbling the ball.

8. EXCLUSION FOULS

8.1. Improper Entry: Entry of a player into the game during play not in accordance with the rules.

8.2. Improper Re-entry: Entry of a substitute into the game during play not in accordance with the rules.

8.3. Exclusion Foul: A foul where a player is excluded from taking part in the game for a period of time as prescribed in the Rules.

8.4. Misconduct: Any improper behaviour, including being disrespectful towards a referee or opponent, as well as showing

disregard for an instruction from the referee.

8.5. Violent action: An action by a player intended to cause harm or to injure another player or official, regardless of whether contact is made.

8.6. Aggressive foul play: Behaviour that can lead to injuries of opponents. The intention of these kind of fouls is to destroy and completely stop the advantage or progress of the game or a player, or to provoke the opponent. It is dangerous play, without a clear intention to injure the opponent player, but typically is caused by emotions.

8.7. Persistent foul play: Unallowed fouls of defending players, which are stopping the attack. The intention of these fouls is not to injure an opponent, but to destroy the flow of the game, advantage and speed, as well as to intimidate the opponent.

8.8. To Impede: To obstruct movement with unallowed physical acts, like holding or blocking an opponent.

8.9. To hold an opponent: To use the hands, arms or legs to hold onto an opponent with the intention of restricting movement.

8.10. To sink: To push an opponent under the water.

8.11. To Pull back: To pull an opposing player.

8.12. To interfere with a free throw, goal or penalty throw: To disrupt or interfere with the taking of any of these throws.

8.13. Disproportionate movements: To make any movement with intent to kick or strike, even if the player fails to make contact.

8.14. To strike: Means “to hit”.

8.15. Tactical foul: Any foul by a defender with the objective to stop the flow of the game with intent to take away an advantage, especially the counterattack.

8.16. Counterattack: The transition by the attacking team that brings the ball quickly from one end of the field to the other in an attempt to score before the defensive team can get into position.

9. PENALTY FOULS

9.1. Penalty Foul: Any foul committed inside 6 metres

preventing a probable goal (VI.10.2). Additionally, violent action (VI. 9.14), and delaying the game (VI. 10.10) may result in a penalty as well as VI. 10.9.

9.2. Probable goal situation: Situations in which the attacking player is facing the goal and there is no defending player between the attacking player and the goalkeeper, and without a foul, a goal would most likely be scored. There are also probable goal situations when the goal is empty and the ball nearby, as well as examples described in the Manual.

9.3. Bad pass: A pass which cannot be reached by the attacker, regardless of whether or not the player has been fouled. There are no sanctions against the defending player in the case of a bad pass.

9.4. Front position on a defender: An offensive player establishing an advantageous position, that is, a position between a defending player and the opponent's goal.

9.5. Delaying the game: Intentionally preventing attacking players from proceeding with the action or any interference against the spirit of the game with the intention to prevent a probable goal.

9.6. Illegal Player: A player not entitled to participate in the game.

10. FREE THROWS

10.1. Free Throw: A method of putting the ball into play after an ordinary foul, an exclusion foul or a restart after a timeout, a goal, an injury including bleeding, the replacement of a cap, the referee calling for the ball, the ball leaving the side of the field of play or any other delay.

10.2. To block a shot or pass: To stop the ball's flight with hand, arm or body.

10.3. Shot: An attempt to score by purposely directing the ball towards the opponent's goal

11. GOAL THROWS

11.1. Throw: Any movement by hand releasing the ball, with

intent to put the ball into play or pass or score.

11.2. Free Throw: The method of putting the ball into play following a foul or stoppage.

11.3. Goal Throw: The throw awarded to the defending team as described in VI. 12.

11.4. Dribble the ball: To swim with the ball or progress the ball by swimming. A player dribbling the ball is in possession of the ball but is not holding the ball.

11.5. Pass the ball: To throw the ball from one player to a teammate or to the area controlled by a teammate. To throw the ball towards a teammate (or to oneself) with the intention of keeping control of the ball (as opposed to the intention to score a goal).

12. CORNER THROWS

12.1. Corner Throw: Throw awarded to the attacking team on the defender's 2m line as described in VI. 13.2.

12.2. Direct shot: The ball may be shot directly at the goal:

A) following a free throw when the player, the ball and the foul are outside the 6 M line,

B) from a penalty throw,

C) from a corner throw. (Described in VI.7.2)

13. NEUTRAL THROWS

13.1. Neutral Throw: Method of putting the ball into play when neither team has possession. The referee restarts play by throwing the ball into the pool between two opposing players, giving each an equal opportunity to recover the ball.

14. PENALTY THROWS

14.1. Penalty Throw: A free shot at the goal from the 5 metre line defended only by the goalkeeper. The defending goalkeeper shall be positioned on the goal line between the goal posts and may move forward after the referee gives the signal for the shot to be taken. Defending players may only enter the 6 metre area after the ball has left the hand of the shooting player.

15. PERSONAL FOULS

15.1. Personal Foul: Individualized foul recorded against a player, when the referee awards an exclusion or a penalty foul.

16.ADDENDUM WITH SOME OTHER OBSERVATIONS AND CLARIFICATIONS:

16.1. Transition: The phase of the game when a team changes from offense to defense or from defense to offense.

16.2. Attacking player: Player whose team has possession of the ball; the team controls the ball and has the opportunity to score a goal.

16.3. Defending player: Player whose team does not control, and does not have possession of, the ball; a player trying to defend the team's goal.

APPENDIX 4 - FIELD OF PLAY & EQUIPMENT

1 – FIELD OF PLAY

1.1 The promoting organisation shall be responsible for the correct measurements and markings of the field of play and shall provide all required fixtures and equipment.

1.2 The layout and markings of the field of play for a game officiated by two referees shall be in accordance with this diagram:

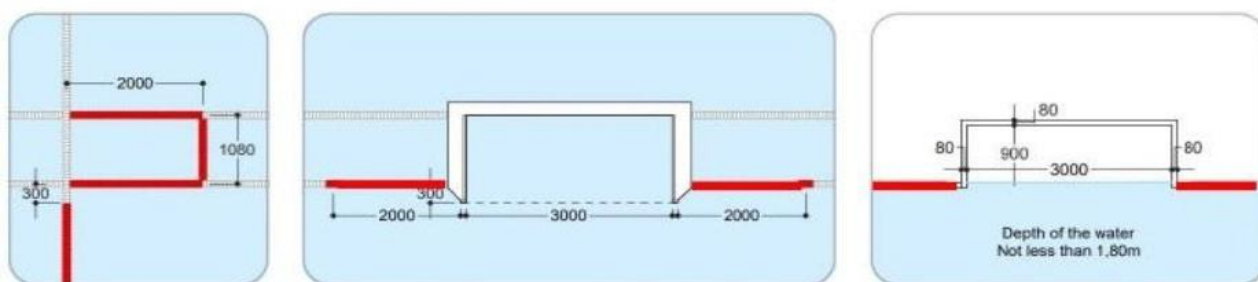

Boundary lines from the goal posts in 2m long shall be marked in red to distinguish the goal areas (VI 8.10)

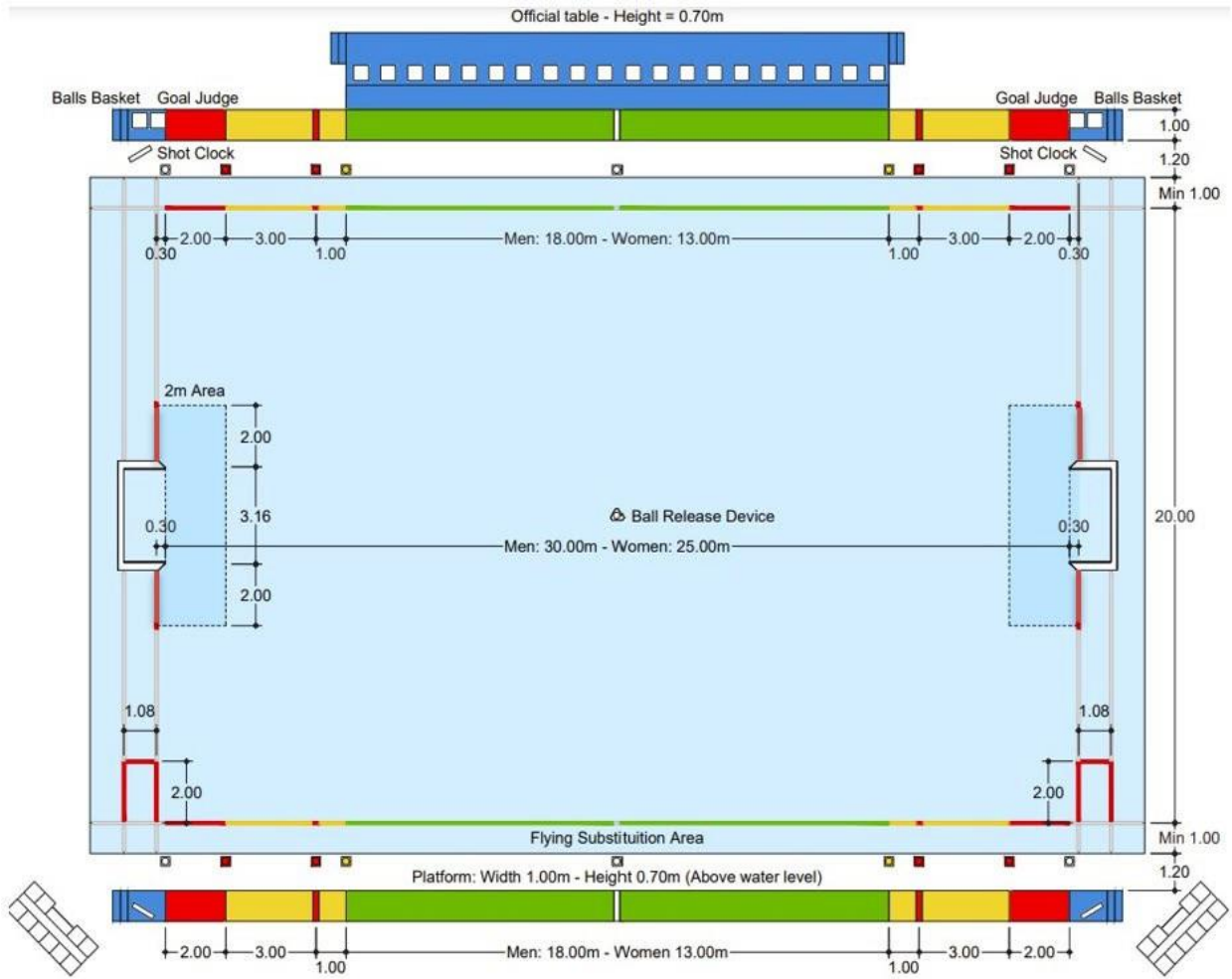

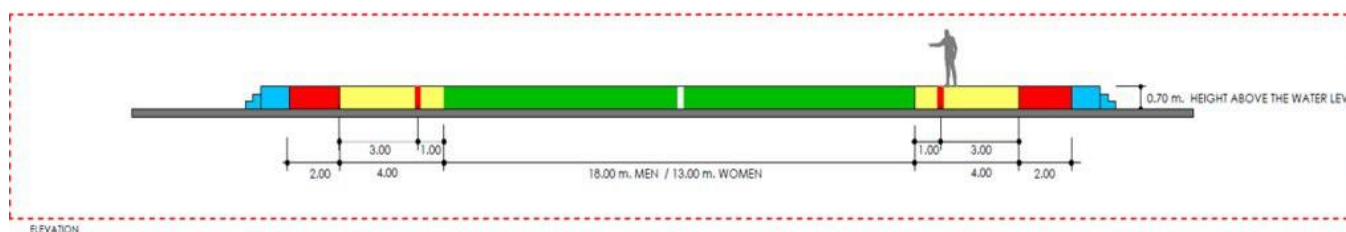
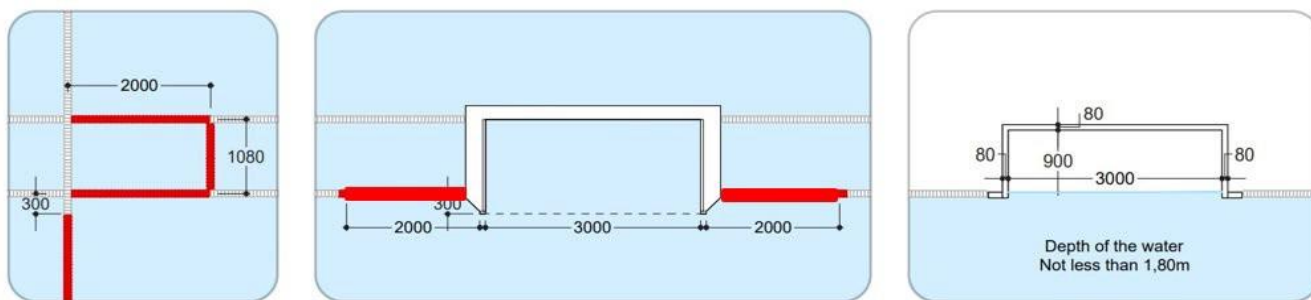

1.3 In a game officiated by one referee, the referee shall officiate on the same side as the official table, and the goal judges shall be situated on the opposite side.

1.4 For World Aquatics events, the dimensions of the field of play, water depth and temperature, and light intensity shall be as set forth in the Water Polo Facilities Rules. (VI 18)

1.5 Distinctive marks shall be provided on both sides of the field of play to denote the following:

- (a) white marks - goal line and half distance line
- (b) red marks - 2 metres from goal lines
- (c) yellow marks - 6 metres from goal lines
- (d) a red marker shall be placed 5 metres from goal lines to indicate the point from which a penalty shot must be taken.

The sides of the field of play from the goal line to the 2 metre line shall be marked in red; from the 2 metre line to the 6 metre line shall be marked in yellow and from the 6 metre line to the half distance line shall be marked in green.

1.6 A red mark shall be placed at each end of the field of play, 2 metres from the corner of the field of play on the side opposite to

the official table, to denote the exclusion re-entry area.

1.7 Sufficient space shall be provided to enable the referees to have free movement from end to end of the field of play. Space shall also be provided at the goal lines for the goal judges.

1.8 The secretary shall be provided with separate white, blue, red and yellow flags, each measuring 0.35 metres x 0.20 metres.

2. GOALS

2.1 Two goal posts and a crossbar, rigidly constructed, rectangular with a dimension of 0.075 metres facing the field of play and painted white shall be located on the goal lines at each end, equal distances from the sides and not less than 0.30 metres in front of the ends of the field of play.

2.2 The inner sides of the goal posts shall be 3 metres apart. When the water is 1.50 metres or more in depth, the underside of the crossbar shall be 0.90 metres from the water surface. When the water is less than 1.50 metres in depth, the underside of the crossbar shall be 2.40 metres from the floor of the pool.

2.3 Limp nets shall be securely fastened to the goal posts and crossbar to enclose the entire goal area and shall be attached to the goal fixtures in such a manner as to allow not less than 0.30 metres clear space behind the goal line everywhere within the goal area.

3. BALL

3.1 The ball shall be round and shall have an air chamber with a self-closing valve. It shall be waterproof, without external strapping or any covering of grease or similar substance.

3.2 The weight of the ball shall be not less than 400 grammes and not more than 450 grammes.

3.3 For games played by men, the circumference of the ball shall be not less than 0.68 metres and not more than 0.71 metres, and its pressure shall be 7.5 to 8.5 pounds per square inch atmospheric.

3.4 For games played by women, the circumference of the ball shall be not less than 0.65 metres and not more than 0.67 metres, and its pressure shall be 6.5 to 7.5 pounds per square inch

atmospheric.

4. CAPS

4.1 Caps shall be of contrasting color, other than solid red, as approved by the referees, but also to contrast with the color of the ball. A team may be required by the referees to wear white or blue caps. The goalkeepers shall wear red caps with numbers and/or ear guards in the same colour as their team members' caps. Caps shall be fastened under the chin. If a player loses the cap during play, the player shall replace it at the next appropriate stoppage of the game when the player's team is in possession of the ball. Caps shall be worn throughout the entire game.

4.2 Caps shall be fitted with malleable ear protectors which shall be the same color as the team's caps.

4.3 Caps shall be numbered on both sides with numbers 0.10 metres in height. The goalkeeper shall wear cap no. 1 and the other caps shall be numbered 2 to 13. A substitute goalkeeper shall wear a red cap numbered 13. A player shall not be allowed to change cap number during the game except with the permission of a referee and with notification to the secretary.

4.4 For international games, the caps shall display on the front the international three letter country code and may display the national flag. The country code shall be 0.04 metres in height.

5. VISIBLE CLOCKS

5.1 Any visible clock shall show the time in a descending manner.

APPENDIX 5 - OFFICIALS

1. OFFICIALS FOR WORLD AQUATICS EVENTS

1.1 For World Aquatics events the officials shall consist of two referees, two assistant referees, timekeepers and secretaries and a video assistant referee, each with the following powers and duties. These officials shall also be provided wherever possible for other events, except that in a game refereed by two referees and no assistant referees, the referees shall assume the duties (but without making the specified signals) allocated to the assistant referees.

Depending on the degree of importance, games can be controlled by teams of four to nine officials, as follows:

(a) Referees and assistant referees: Two referees and two assistant referees; or two referees and no assistant referees; or one referee and two assistant referees.

(b) Timekeepers and secretaries: With one timekeeper and one secretary: The timekeeper shall record the periods of continuous possession of the ball by each team, in accordance with VI.8.14. The secretary shall record the exact periods of actual play, timeouts and the intervals between periods, maintain the record of the game as set out in VI.10.1 and shall also record the respective periods of exclusion of players ordered from the water in accordance with the Rules.

With two timekeepers and one secretary: Timekeeper No. 1 shall record the exact periods of actual play, timeouts and the intervals between periods. Timekeeper No. 2 shall record the periods of continuous possession of the ball by each team, in accordance with VI.8.14. The secretary shall maintain the record of the game and perform all other duties as set out in the Water Polo Rules.

With two timekeepers and two secretaries: Timekeeper No. 1 shall record the exact periods of actual play, timeouts and the intervals between periods. Timekeeper No. 2 shall record the periods of continuous possession of the ball by each team, in accordance with VI.8.14. Secretary No. 1 shall maintain the record of the game. Secretary No. 2 shall carry out the duties relating to the improper re-entry of excluded players, improper entry of substitutes,

exclusion of players and the third personal foul.

(c) Video assistant referee: shall assist the two referees as called for by the Rules.

2. REFEREES

2.1 The use of audio equipment by the referees of the match. During the match, both referees shall have an audio headset for communication between themselves. The delegate and the VAR assistant referees will also have one, but only to receive information for the official table and to ensure clarity.

2.2 All decisions of the referees on questions of fact shall be final and their interpretation of the Rules shall be obeyed throughout the game. The referees shall not make any presumption as to the facts of any situation during the game but shall interpret what they observe to the best of their ability.

2.3 The referees shall whistle to start and restart the game and to declare goals, goal throws, corner throws (whether signalled by the assistant referee or not), neutral throws and infringements of the Rules. A referee may alter a decision provided it is done before the ball is put back into play.

2.4 The referees shall have the power to order any player from the water in accordance with the appropriate Rule and to abandon the game should a player refuse to leave the water when so ordered.

3. ASSISTANT REFEREES

3.1 The assistant referees shall be situated on the same side as the official table, each on the goal line at the end of the field of play.

3.2 The duties of the assistant referees shall be:

- a) to signal by raising one arm vertically when the players are correctly positioned on their respective goal lines at the start of a period;
- b) to signal by raising both arms vertically for an improper start or restart;

- c) to signal by pointing with the arm in the direction of the attack for a goal throw;
- d) to signal by pointing with the arm in the direction of the attack for a corner throw;
- e) to signal by raising and crossing both arms for a goal;
- f) to signal by raising both arms vertically for an improper re-entry of an excluded player or improper entry of a substitute.

3.3 Each assistant referee shall be provided with a supply of balls and when the original ball has gone outside the field of play, the assistant referee shall immediately throw a new ball to the goalkeeper (for a goal throw), to the nearest player of the attacking team (for a corner throw), or as otherwise directed by the referee.

4. TIMEKEEPERS

4.1 The duties of the timekeepers shall be:

- a) to record the exact periods of actual play, timeouts and the intervals between the periods;
- b) to record the periods of continuous possession of the ball by each team;
- c) to record the exclusion times of players ordered from the water in accordance with the Rules, together with the re-entry times of such players or their substitutes;
- d) to audibly announce the start of the last minute of the game;
- e) to signal by whistle after 45 seconds and at the end of each timeout.

4.2 A timekeeper shall signal by whistle (or by any other means provided it is distinctive, acoustically efficient and readily understood), the end of each period independently of the referees and the signal shall take immediate effect except:

- a) in the case of the simultaneous award by a referee of a penalty throw, in which event the penalty throw shall be taken in accordance with the Rules;
- b) if the ball is in flight and crosses the goal line, in which event any resulting goal shall be allowed.

5. SECRETARIES

5.1 The duties of the secretaries shall be:

(a) to maintain the record of the game, including the players, the score, timeouts, exclusion fouls, penalty fouls, and personal fouls awarded against each player;

(b) to control the periods of exclusion of players and to signal the expiration of the period of exclusion by raising the appropriate flag or by another approved method of signalling; except that a referee shall signal the re-entry of an excluded player or a substitute when that player's team has retaken possession of the ball. After 4 minutes, the secretary should signal the re-entry of a substitute for a player who has been excluded for violent action by raising the yellow flag along with the appropriate coloured flag or by another approved method of signalling;

(c) to signal with the red flag and by whistle, or by another approved method of signalling, for any improper re-entry of an excluded player or improper entry of a substitute (including after a signal by an assistant referee to indicate an improper re-entry or entry), which signal shall stop play immediately;

(d) to signal, without delay, the award of a third personal foul against any player as follows:

(i) with the red flag, or by another approved method of signalling, if the third personal foul is an exclusion foul;

(ii) with the red flag and a whistle, or by another approved method of signalling, if the third personal foul is a penalty foul.

6. VIDEO ASSISTANT REFEREE

6.1 The duties of the Video Assistant referee shall be:

(a) to alert and assist the match referee(s) in doubtful "goal / no goal" situations or in case of violent action situations by providing the video footage at the appropriate moment.

(b) if necessary, in other situations, to provide assistance to the referees with video footage;

(c) to show the match referee(s) re-plays of other incidents, when requested.

7. INSTRUCTIONS FOR THE USE OF TWO REFEREES

7.1 The referees are in absolute control of the game and shall have equal powers to declare fouls and penalties. Differences of opinion of the referees shall not serve as a basis for protest or appeal.

7.2 The committee or organisation appointing the referees shall have power to designate the side of the pool from which each referee shall officiate. Referees shall change sides of the pool before the start of any period when the teams do not change ends.

7.3 At the start of the game and of each period, the referees will position themselves on the respective six (6) metre line. The starting signal shall be given by the referee on the same side as the official table.

7.4 After a goal, the signal to restart shall be given by the referee who was controlling the attacking situation when the goal was scored. Before restarting, the referees shall ensure that any substitutions have been completed.

7.5 Each referee shall have the power to declare fouls in any part of the field of play but each referee shall give primary attention to the offensive situation attacking the goal to the referee's right. The referee not controlling the attacking situation (the defensive referee) generally shall maintain a position no closer to the goal being attacked than that player of the attacking team furthest back from the goal.

7.6 When awarding a free throw, goal throw or corner throw, the referee making the decision shall blow the whistle and both referees shall indicate the direction of the attack, to enable players in different parts of the pool to see quickly which team has been awarded the throw. Referees shall use the signals set out in the following C.8 to indicate the nature of the fouls which they are penalizing.

7.7 The signal for a penalty throw to be taken shall be made by the attacking referee, except that a player who wishes to take the throw with the left hand may request the defensive referee to make

the signal.



7.8 When simultaneous awards are made for ordinary fouls but for opposing teams, the award shall be a neutral throw by the attacking referee.





7.9 When simultaneous awards are made by both referees and one is for an ordinary foul and the other is for an exclusion foul or penalty foul, the exclusion foul or penalty foul award shall be applied.





7.10 When players of both teams commit an exclusion foul simultaneously during play, the referees shall call the ball from the water and make sure both teams and the secretaries know who is excluded. The possession clock is not reset and play is restarted with a free throw to the team which had possession of the ball. If neither team had possession when the simultaneous exclusions were called, the possession clock is reset to 30 seconds and play shall be restarted with a neutral throw.





7.11 In the event of simultaneous awards of penalty throws to both teams, the first throw shall be taken by the team last in possession of the ball. After the second penalty throw has been taken, the game will restart with the team which had possession of the ball receiving a free throw on or behind the half distance line. The possession clock is reset to 30 seconds.



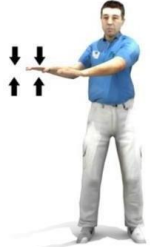

8. SIGNALS TO BE USED BY OFFICIALS





| | |
|---|---|
| <p>A. The referee lowers the arm from a vertical position to signal (i) the start of the period (ii) to restart after a goal (iii) the taking of a penalty throw.</p> |  |
| <p>B. To point with one arm in the direction of the attack and, if necessary, to use the other arm to indicate the place where the ball is to be put into play at a free throw, goal throw or corner throw.</p> |  |





| | |
|--|---|
| <p>C. To signal a neutral throw. The referee points to the place where the neutral throw has been awarded, points both thumbs up and calls for the ball.</p> |  |
| <p>D. To signal the exclusion of a player. The referee points to the player and then moves the arm quickly towards the boundary of the field of play. The referee then signals the excluded player's cap number so that it is visible to the field of play and the table.</p> |  |
| <p>E. To signal the simultaneous exclusion of two players. The referee points with both hands to the two players, signals their exclusion in accordance with Fig. D, and then immediately signals the players' cap numbers.</p> |  |
| <p>F. To signal the exclusion of a player for misconduct. The referee signals exclusion in accordance with Fig. D (or Fig. E if appropriate) and then rotates the hands round one another in such a way that is visible to both the field of play and the table in addition to issuing the player with a red card. The referee then signals the excluded player's cap number to the table.</p> |  |

| | |
|--|---|
| <p>G. To signal the exclusion of a player with substitution after four (4) minutes. The referee signals exclusion in accordance with Fig D (or Fig. E if appropriate) and then crosses the arms in such a way that is visible to both the field of play and the table in addition to issuing the player with a red card. The referee then signals the excluded player's cap number to the table.</p> |  |
| <p>H. To signal the award of a penalty throw. The referee raises an arm with five fingers in the air. The referee then signals the offending player's cap number to the table.</p> |  |
| <p>I. To signal that a goal has been scored. The referee signals by whistle and by immediately pointing to the centre of the field of play.</p> |  |
| <p>J. To indicate the exclusion foul of holding an opponent. The referee makes a motion holding the wrist of one hand with the other hand.</p> |  |

| | |
|--|---|
| <p>K. To indicate the exclusion foul of sinking an opponent. The referee makes a downward motion with both hands starting from a horizontal position.</p> |  |
| <p>L. To indicate the exclusion foul of pulling back an opponent. The referee makes a pulling motion with both hands vertically extended and pulling towards their body.</p> |  |
| <p>M. To indicate the exclusion foul of kicking an opponent. The referee makes a kicking movement.</p> |  |
| <p>N. To indicate the exclusion foul of striking an opponent. The referee makes a striking motion with a closed fist starting from a horizontal position.</p> |  |
| <p>O. To indicate the ordinary foul of pushing or pushing off from an opponent. The referee makes a pushing motion away from the body starting from a horizontal position.</p> |  |

| | |
|---|---|
| | |
| <p>P. To indicate the exclusion foul of impeding an opponent. The referee makes a crossing motion with one hand horizontally crossing the other.</p> |  |
| <p>Q. To indicate the ordinary foul of taking the ball under the water. The referee makes a downward motion with a hand starting from a horizontal position.</p> |  |
| <p>R. To indicate the ordinary foul of standing on the bottom of the pool. The referee raises and lowers one foot.</p> |  |
| <p>S. To indicate the ordinary foul of undue delay in the taking of a free throw, goal throw or corner throw. The referee raises a hand once or twice with the palm turned upwards.</p> |  |

| | |
|--|---|
| <p>T. To indicate the ordinary foul of a violation of the two-metre rule. The referee indicates the number 2 by raising the fore and middle fingers in the air with the arm vertically extended.</p> |  |
| <p>U. To indicate the ordinary foul of expiry of possession time. The referee moves a hand in a circular motion two or three times.</p> |  |
| <p>V. To indicate that a direct shot from outside the 6 m. area is permitted.</p> |  |
| <p>W. To indicate a change of possession</p> |  |

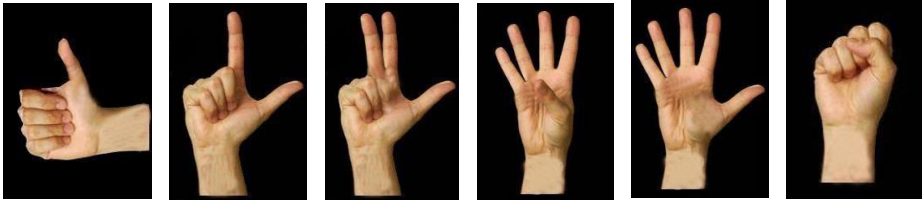
| | |
|--|---|
| <p>X. By an assistant referee to signal for the start of a period</p> |  |
| <p>Y. By an assistant referee to signal an improper start, restart or improper re-entry of an excluded player or substitute.</p> |  |
| <p>Z. By an assistant referee to signal a goal throw or corner throw.</p> |  |
| <p>AA. By an assistant referee to signal a goal.</p> |  |
|  | |

To indicate a player's cap number. To enable the referee to communicate

better with the players and the secretary, signals are made using both

hands if appropriate where the number exceeds five. One hand shows five fingers with the other hand showing additional fingers to make up the sum of the player's number. For the number ten, a clenched fist is shown. If the number exceeds ten, one hand is shown as a clenched fist with the other hand showing additional fingers to make up the sum of the player's number.

APPENDIX 6 - PENALTY SHOOT OUT

1. Officials Involved

- **1.1 Delegates:** priority to check if the shooters can participate in PSO (no player with three (3) personal fouls or has received a red card or can no longer participate due to injury) and to control the same order of shooters (five (5) shooters) after the first round of penalties has taken place.
- **1.2 Referees:** priority to control the field of play, benches, position of goalkeepers and shooters in the field of play.
- **1.3 Video Assistant Referee:** goal no goal assistant if needed.

2. Procedure

2.1 If a penalty shootout (PSO) has to determine the outcome of a game (according to VI 4.3), the following procedure and protocols must be followed.

2.2 Immediately after the end of the 4th period, there is a **3-minutes break** during which the following actions need to be completed:

- a. the players leave the water and sit on their respective team benches, except for five (5) shooters from each team who will remain in the water in their respective team's half of the field of play, and the goalkeepers.
- b. the goalkeepers change ends and position themselves in the goal in the opposite team's half of the field.
- c. the referee who last officiated on the side of the team benches will call the team captains and with a coin toss will determine which team will shoot the first penalty.
- d. Assistant referees are not involved in PSO.

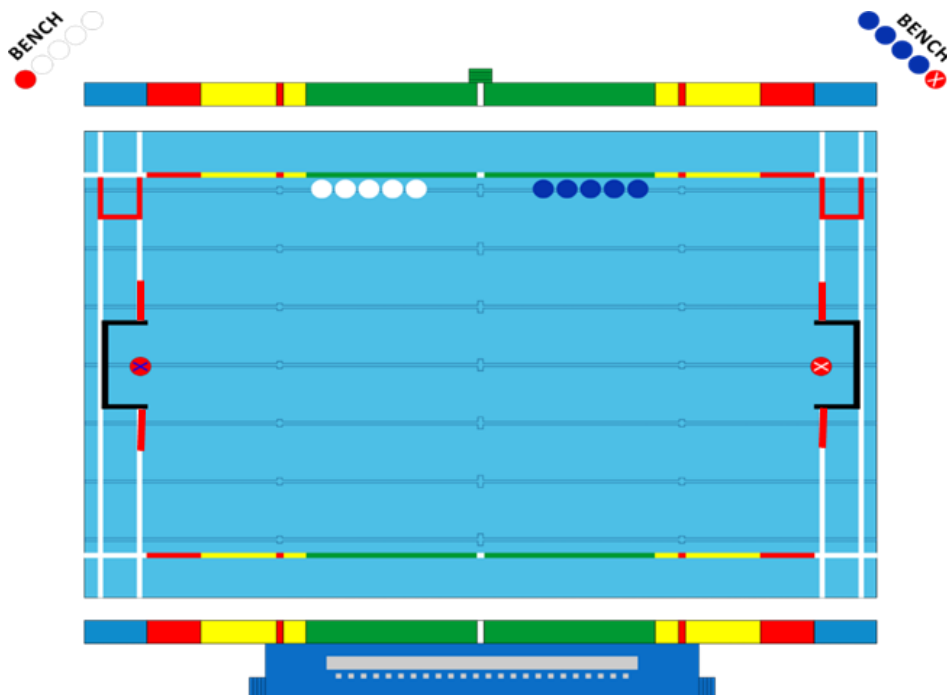

2.3 After the end of the 3-minute break, the PSO will start immediately. If a team fails to be ready on time, the team's coach shall be warned by issuing a **yellow card**. If the coach has already been warned with a yellow card, a red card shall be issued for delaying the PSO. If the head coach has already been excluded, any other bench official can only receive a red card for delaying the PSO.

2.4 When shooting alternately at each goal, only **one referee** will control each penalty. Referees will position themselves on the 5-metre lines at opposite ends of the field such that right-handed shooters can easily observe the referee's signals. A referee will only walk to the other end of the field if a left-handed shooter is ready to take the next penalty.

2.5 Multiple balls can be used for the PSO. The ball shall not be thrown from one end of the field to the other. Each side will use their own set of balls.

2.6 The order in which shooters of each team shall be determined is the order in which they shoot the first round of five (5) penalties. (No list of shooters needs to be written down before the start of the PSO.) The secretary shall record the numbers of the players who take the penalties and, together with the delegate, shall check that the shooters are eligible to participate in the PSO (no three (3) personal fouls or excluded with red card, or due to injury). If the teams are tied after the first round of five (5)

penalty shots, the same players shall continue in the same order as established after the first round of penalty takers.

2.7 Shots will be taken alternately at each end of the field of play, unless conditions at one end of the field of play advantage and/or disadvantage a team, in which case all shots may be taken at the same end.

3. Substituting the goalkeeper.

3.1 Substituting the goalkeeper, during the PSO, is allowed according to the following procedure (see below the green arrows):

- a. The substitute goalkeeper has to walk to the half distance line and then to swim to the goal and take the position of the first goalkeeper.
- b. The goalkeeper who is substituted must swim to the side of the jury table and and to wait out of 6 meters and outside the field of play (to be re-substituted or until the end of PSO).

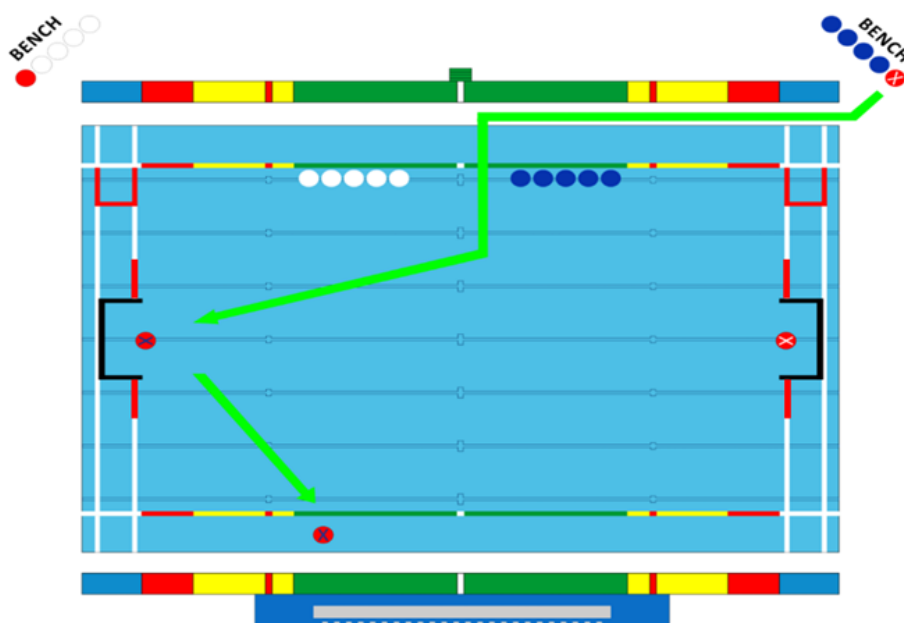

4. Re-substituting the goalkeeper

4.1 It is possible to substitute the goalkeeper again during a PSO by swimming according to the green arrows below:

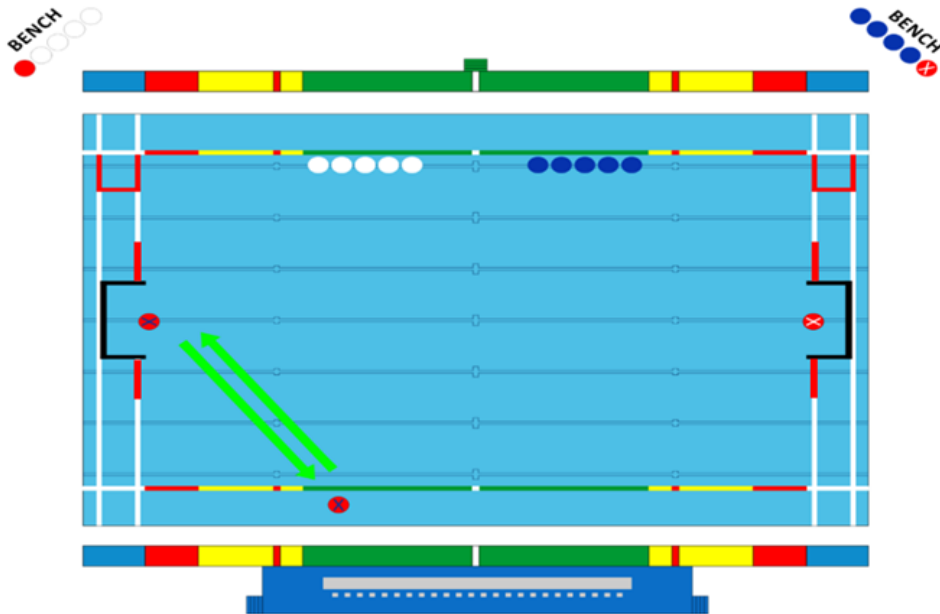

5. Exclusion of goalkeeper and players during penalty shoot out

5.1 If the goalkeeper is excluded during the penalty shoot out, a player from the five players in the water, may substitute for the goalkeeper but without the privileges of the goalkeeper; following the taking of the penalty shot, the player may be substituted by another player or alternate goalkeeper.

5.2 If a field player is excluded during the penalty shoot out, the player's position is removed from the sequence of the five players participating in the penalty shoot out, and a substitute player is placed in the last position of the sequence.

6. Summary

During the PSO:

- 1.** The secretary and the delegate control the correct order of the shooters and the score.
- 2.** The referees manage the teams.
- 3.** No warming up is allowed during the PSO.
- 4.** All players not involved in the PSO must sit on the bench together with the team officials.
- 5.** During the PSO, none of the players is allowed to hang onto the line.
- 6.** A goalkeeper can substitute by swimming, as indicated in the PSO protocol, to the goal.
- 7.** The substituted goalkeeper will stay in the water, out of the 6 metre line and outside the field of play.
- 8.** Every subsequent substitution of the goalkeeper occurs in a similar manner.

APPENDIX 7 - VAR PROTOCOL

The purpose of World Aquatics VAR protocol is to provide the integrity, transparency for all Water Polo games and eliminate the failure of the human factor with the assistance of modern technology.

1. PRINCIPLES

The final decision is always made by the referees. The referee can change his/her original decision based on facts from the VAR review.

Only the referee of the match can request a review. The Video Assistant Referee and the delegate can only alert the referee to conduct a review.

The referee will stop the match at an appropriate moment, as soon as possible.

During a VAR review the referee should remain visible throughout the process.

Accuracy is more important than speed, therefore there is no time pressure to review the decision quickly.

A match is not invalidated because of malfunction(s) of the VAR technology, wrong decision(s) involving the VAR, decision(s) not to review an incident or review(s) of a non-reviewable situation.

1.1 Appropriate moment definition

- Neither team has possession of the ball
- Interval time
- Corner throw
- Team in possession of the ball has no clear advantage.
- At the latest, the review should be done after the first attack following a doubtful “GOAL / NO GOAL” situation.

2. SITUATIONS FOR REVIEW DURING THE MATCH

The use of VAR is limited to the following categories of decisions:

- Goal/ No goal.
- Goal scored at shot clock expiration or at the end of a period.
- Jury table errors and/or failures of the electronic system including time out buttons.

- When there is a shot taken at the end of a period and there is an excluded player.
- Review of a violent action situation.
- Interference with the taking of a penalty throw.

2.1 Goal/No goal situation

If the referee or VAR official has doubt about a goal/no goal situation, the referee should review the situation to assess if the ball fully crossed the goal line.

E.2.1.1 If a goal has been awarded:

- One of the referees of the match shall signal that the goal must be reviewed.
- One of the referees takes the ball out of the water.
- One referee, closest to the VAR monitor, reviews the situation and takes the decision to allow or disallow the goal.
- If the goal is cancelled, the former defending goalkeeper will restart the game with a free throw. The players shall be allowed to take any position in the field of play as after a timeout.
- If the goal is allowed, the game restarts according to VI.6.4

2.1.2 If a goal was not awarded:

The Referees of the match must find an appropriate moment, as quickly as possible after the situation, to review it. It should happen soon after the end of the first attack following the doubtful “GOAL / NO GOAL” situation.

After reviewing if a goal is awarded:

the game restarts according to VI.6.4 the time is reset to the moment when the goal was scored, all goals and personal fouls are nullified but all yellow and red cards, acts of violence and misconduct will remain on the match protocol.

After reviewing if a goal is not awarded:

the game restarts with a free throw taken by the team which last had possession, the time is not reset, and the players are allowed to take any position in the field of play as after a time out.

2.2 A Goal scored at the expiration of the shot clock or at the end of a period.

When a goal was scored very close to shot clock time expiration, or during the time expiration at the end of a period, the referee should check if the ball left the hand of the attacker before the time expired.

The video review will only be done immediately after a goal was scored

from this shot.

If the result of the shot was a corner throw or rebound, no video review shall be done.

If this situation happens at the end of a period or end of the game, the period or the game will not be ended. After the referee has done a VAR review and made the decision public, the referees will end the period or game.

2.3 An excluded player at the end of a period

When a player is excluded at the end of a period, and at the expiration of time the attacking team shoots at the goal, the VAR equipment must be used to assess if there was a change of possession in order to determine if the following period of the match will be restarted with both teams even, or with one player still excluded.

No other situations other than mentioned in 2.2 and 2.3 can be considered for VAR review after time expires.

2.4 Technical errors by jury table officials and / or malfunctioning of electronic equipment (game clock, shot clock, time-out devices)

In situations when technical errors of the table officials or malfunctioning of electronic equipment occurs, the referee may use the VAR system to determine the correct solution for the situation.

Determining and resolving the situation shall be made before the match is restarted.

2.5 Suspicion of an incident of violence

If the referee or VAR referee or delegate suspect that a violent action may have occurred, the referees may use VAR to review the situation.

If the game is stopped at the moment of suspicion of violence:

- if a violent action was determined, the referees will sanction the incident according to the rules and the game should recommence from the time of the incident.
- If a violent action was not determined, the game will proceed according to the rules.

If the game was stopped at an appropriate moment and violent action was determined, all goals and personal fouls between the time of the incident and time of stoppage are then nullified, but all yellow and red cards, acts of violence and misconduct, will remain on the match protocol.

2.6 Interference during the taking of a penalty throw

In situations when the referees or VAR referee suspect interference during the taking of a penalty throw, the referees can use the VAR equipment to check the situation.

Based on the decision, the game continues from the appropriate moment as described in the rules.

3. REVIEW PROCESS

Step 1

- a)** The referee informs the VAR that a decision/incident should be reviewed (check).
- b)** The VAR official or delegate recommends to the referees that a decision/incident should be reviewed (check).

Step 2

The referees, if necessary, decide to stop the game to review the video at an appropriate moment (see 1.1).

Step 3

Reviewing the doubtful situation on the VAR monitor.

Step 4

The referee communicates the final decision by going to the centre of the field of play and clearly indicating the decision and how the match will continue.

The Public Announcer must announce both the stoppage of the game to review the situation as well as the referee's decision after the review. A message may be displayed on the scoreboard as well.

Step 5

Restart of the game after the final decision.

4. POSITION OF THE PLAYERS DURING A VAR REVIEW

Players must remain in their respective halves of the field of play during the VAR review.

During any Video Review, no substitution is allowed from any of the re-entry areas before the referee communicates the decision after the Video Review.

The referee who is not reviewing VAR should control the players of both teams so that they can take up the correct positions in the field.

5. NO REASON FOR PROTEST

The result of a match should not be invalidated because of malfunction(s) of the VAR technology, wrong decision(s) involving the VAR, decision(s) not to review an incident or review(s) of a non-reviewable situation.

6. VIDEO REVIEW REQUEST

Post-match reviews will only be accepted on the request form provided by World Aquatics no later than 30 minutes after the game in which the incident occurred.

The TWPC does not review any incident if there is no official request from a team.

After the match a team, which was involved in the game may request a Video Review. This request may be done under the same conditions as filing a protest form after the match.

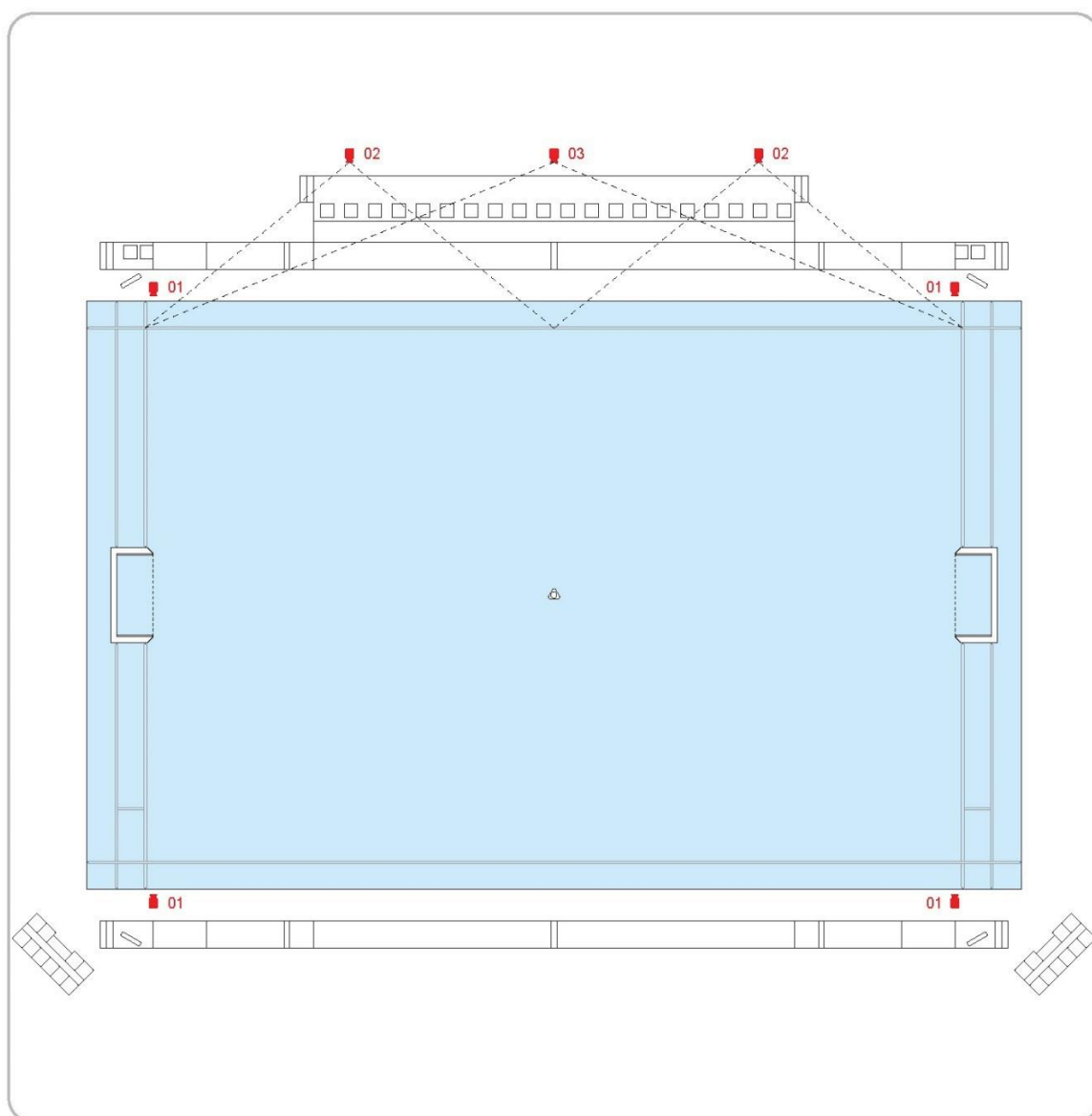
Cameras

1. Four cameras on the goal lines, two per goal. The location of the cameras should be at the edge of the pool or under referee's catwalk at about 1 m above the water level
2. Two cameras shall be fixed on the same side of the jury table. Each camera should film each a half of the field of play accordingly. The location of the cameras shall be that provide the best quality of video recording.
3. One camera is located at the side of the pool opposite to the benches. This camera shall film the entire field of play including both benches. This camera shall be capable to shoot at biggest possible angle (160 degrees is maximum today) with minimum resolution 2K pixels.

APPENDIX 8 - AGE GROUP TOURNAMENTS

- 1.** All age group competitors remain qualified from 1 January to the following 31 December at their age at the close of day (12 midnight) on 31 December of the year of competition.
- 2.** Age grouping for Water Polo for boys and girls are as follows:
 - 15 and 16 years of age and under (16U)
 - 17 and 18 years of age and under (18U)
 - 19 and 20 years of age and under (20U)

APPENDIX 9 - TOURNAMENT STRUCTURE

1. Water Polo Tournaments at Olympic Games and World Aquatics Championships

1.1. Olympic Games - Tournament Men

1.1.1 Draw

The draw for the Olympic Games Tournament will be either on the last day of the Olympic Games Qualification Tournament - Men or as otherwise determined and the following principle shall apply: if a team is already qualified by its ranking from a preceding qualification competition, the team will be placed on the highest line of the draw according to that ranking and the team taking its place will be placed on the lower line.

For the Preliminary Round, all qualifying teams will be drawn by pairs into two groups, either A or B.

First Line, the first and second placed teams from the previous World Championship will be drawn, one into A, and one into B.

Second Line, the team qualified from the preceding year's World League and the team representing the Continent of Europe will be drawn, one into A, and one into B.

Third Line, the teams representing the Continents of America and Oceania will be drawn, one into A, and one into B.

Fourth Line, the teams representing the Continents of Africa and Asia will be drawn, one into A, and one into B.

Fifth Line, the first and second placed teams from the Olympic Games Qualification Tournament - Men will be drawn, one into A, and one into B.

Sixth Line, the third placed team in the Olympic Games Qualification Tournament

Men and the team representing the Host Country will be drawn, one into A, and one into B.

Should there be no teams from the previous Championships to seed onto a Line then the highest ranked teams for Europe, Americas, Asia, Africa or Oceania if any, shall be drawn alternating between Group A and Group B.

After being divided into group A and group B, the teams will then be drawn with each team in each group receiving a separate number from one (1) to six (6).

1.1.2 Schedule of Games

Preliminary Round:

There will be two (2) groups of six (6) teams, which form groups A and B.

Each group will play a round robin. The four (4) highest ranked teams in each group will qualify for the Quarter Final Round. The fifth and sixth ranked teams in each group will be eliminated and will not play anymore.

| Day 1 | Day 2 | Day 3 | Day 4 | Day 5 |
|----------|-------------|-------------|-------------|-------------|
| 1. A1-A6 | 7. B6 - B4 | 13. A4 - A5 | 19. B6 - B5 | 25. A5 - A1 |
| 2. A3-A4 | 8. B5 - B3 | 14. A2 - A6 | 20. B1 - B4 | 26. A3 - A6 |
| 3. A2-A5 | 9. B1 - B2 | 15. A3 - A1 | 21. B2 - B3 | 27. A4 - A2 |
| 4. B1-B6 | 10. A6 - A4 | 16. B4 - B5 | 22. A6 - A5 | 28. B3 - B6 |
| 5. B3-B4 | 11. A5 - A3 | 17. B2 - B6 | 23. A1 - A4 | 29. B4 - B2 |
| 6. B2-B5 | 12. A1 - A2 | 18. B3 - B1 | 24. A2 - A3 | 30. B1 - B5 |

Quarter Final Round:

The first, second, third and fourth placed teams in Group A and Group B form a Group D of eight (8) teams. Group D plays a modified single elimination format.

Games played in the Preliminary Round may be repeated in the Quarter Final, Semi Final or Final Round. All games played in Group D must be played so that a definite winner is declared. Accordingly, it may be necessary to apply the Water Polo Rules relating to penalty shoot-out.

Places 11 - 12

The teams ranked sixth in each group of the Preliminary Round shall be classified for places 11 - 12 according to the following criteria:

1. Win-loss record in their Preliminary Round group.
2. If both teams have the same win-loss record, the classification will be determined by goal average

(goals scored divided by games played) taking into account the results of all games played in the respective group.

Places 9 - 10

The teams ranked fifth in each group shall be classified for places 9 - 10 according to the same principles as for places 11 - 12.

Day 6

31. 1A - 4B

32. 2A - 3B

33. 3A - 2B

34. 4A - 1B

Semi Final Round:

Day 7

35. L31 - L33

36. L32 - L34

37. W31 - W33

38. W32 -

W34

Final Round:

Day 8

39. L35 - L36 (Winner 7th, Loser 8th)

40. W35 - W36 (Winner 5th, Loser 6th)

41. L37 - L38 (Winner 3rd, Loser 4th)

42. W37 - W 38 (Winner 1st, Loser 2nd)

Games 31 through 42 must be played to a conclusion, accordingly it may

be necessary to apply Water Polo Rules relating to penalty shoot-out.

The Management Committee of World Aquatics Competitions may change the order and schedule of games to meet with the requirements of the Host Federation and/or television provided that at least twenty four (24) hours' notice is given.

1.2 Olympic Games - Tournament – Women

1.2.1 Draw

The Draw for the Olympic Games Tournament will be either on the last day of the Olympic Games Qualification Tournament – Women or as otherwise determined and the following principle shall apply: if a team is

already qualified by its ranking from a preceding qualification competition, the team will be placed on the highest line of the Draw according to that ranking and the team taking its place will be placed on the lower line.

a) Group Draw

For the Preliminary Round, all qualifying teams will be drawn by pairs into two groups, either A or B.

First Line, the first placed team from the previous World Championship and the first team from the preceding year's World League will be drawn, one into A, and one into B.

Second line, the teams representing the Continents of Europe and Oceania will be drawn, one into A, and one into B.

Third line, the first and second placed teams from the Olympic Games Qualification Tournament - Women will be drawn, one into A, and one into B.

Fourth line, the team representing the Continent of America and the team representing the Continent of Asia will be drawn, one into A, and one into B.

Fifth line, the team representing the Continent of Africa and the team representing the Host Country will be drawn, one into A, and one into B.

b) Team Draw

After being divided into Group A and Group B, the teams will then be drawn with each team in each group receiving a separate number from one (1) to five (5).

1.2.2 Schedule of Games Preliminary Round

Two (2) groups of five (5) teams form Group A and Group B and play a single round robin in each group.

| Day 1 | Day 2 | Day 3 | Day 4 | Day 5 |
|----------|----------|-----------|-----------|-----------|
| 1. A5-A1 | 5. B1-B3 | 9. A5-A2 | 13. A2-A3 | 17. B3-B5 |
| 2. A2-A4 | 6. B4-B5 | 10. A3-A4 | 14. A4-A1 | 18. B1-B2 |
| 3. B5-B1 | 7. A4-A5 | 11. B3-B4 | 15. B2-B3 | 19. A3-A5 |
| 4. B2-B4 | 8. A1-A3 | 12. B5-B2 | 16. B4-B1 | 20. A1-A2 |

Quarter Final Round

The first, second, third and fourth placed teams in Group A and Group B form a Group D of eight (8) teams. Group D plays a modified single elimination format.

Games played in the Preliminary Round may be repeated in the Quarter Final, Semi Final or Final Round. All games played in Group D must be played so that a definite winner is declared. Accordingly, it may be necessary to apply the Water Polo Rules relating to penalty shoot-out.

Places 9 - 10

The teams ranked fifth in each group of the Preliminary Round shall be classified for places 9 - 10 according to the following criteria:

1. Win-loss record in their Preliminary Round group.
2. If both teams have the same win-loss record, the classification will be determined by goal average (goals scored divided by games played) taking into account the results of all games played in the respective group.

Day 6

21. 1A - 4B

22. 2A - 3B

23. 3A - 2B

24. 4A - 1B

Semi Final Round

Day 7

25. L21 - L23

26. L22 - L24

27. W21 - W23

28. W22 - W24

Final Round

Day 8

29. L25 - L26 (Winner 7th, Loser 8th)

30. W25 - W26 (Winner 5th, Loser 6th)

31. L27 - L28 (Winner 3rd, Loser 4th)

32. W27 - W28 (Winner 1st, Loser 2nd)

Games 21 through 32 must be played to a conclusion, accordingly it may be necessary to apply Water Polo Rules relating to penalty shoot- out.

The Management Committee of World Aquatics Competitions may change the order and schedule of games to meet with the requirements of the Host Federation and/or television provided that at least twenty four (24) hours' notice is given.

1.3 World Aquatics Championship – Men**1.3.1 Draw**

The draw for the World Aquatics Championships Tournament will be made two (2) months prior to the commencement of the World Aquatics Championships Tournament and the following principle shall apply: if a team is already qualified by its ranking from a preceding qualification competition, the team will be placed on the highest line of the draw according to that ranking and the team taking its place will be placed on the lower line.

For the Preliminary Round, all qualifying teams will be drawn into four

(4) groups: A, B, C or D.

First Line, the first, second, third and fourth qualified teams from the preceding World Cup or Olympic Games will be drawn one into A, one into B, one into C, and one into D.

Second Line, the qualified teams from the World League (or from the World Cup or Olympic Games if applicable), the first qualified team from the Americas and the first qualified team from Europe will be drawn one into A, one into B, one into C, and one into D.

Third, the second qualified team from the Americas, the second and third qualified teams from Europe and the qualified team from Oceania will be drawn one into A, one into B, one into C, and one into D.

Fourth, the qualified team from Africa, the first and second teams from Asia and the Host Country (if the Host Country has already been drawn, then the next ranked team from the World Cup or Olympic Games) will be drawn one into A, one into B, one into C, and one into D.

After being divided into Groups A, B, C, or D, the teams will then be drawn with each team in each group receiving a separate number from one (1) to four (4).

1.3.2 Schedule of Games Preliminary Round (First):

Four (4) groups of four (4) teams each from Group A, Group B, Group C and Group D play a single robin round in each group.

| Day 1 | Day 2 | Day 3 |
|--------------|--------------|--------------|
| 1. A3 – A1 | 9. B4 – B3 | 17. C1 – C4 |
| 2. A2 – A4 | 10. B1 – B2 | 18. C2 – C3 |
| 3. B3 – B1 | 11. C4 – C3 | 19. D1 – D4 |
| 4. B2 – B4 | 12. C1 – C2 | 20. D2 – D3 |
| 5. C3 – C1 | 13. D4 – D3 | 21. A1 – A4 |
| 6. C2 – C4 | 14. D1 – D2 | 22. A2 – A3 |
| 7. D3 – D1 | 15. A4 – A3 | 23. B1 – B4 |
| 8. D2 – D4 | 16. A1 – A2 | 24. B2 – B3 |

Preliminary Round (Second):

The first placed teams in Group A, Group B, Group C and Group D have a bye.

The second and third placed teams in Group A, Group B, Group C and Group D play against each other in a cross group format. The fourth placed teams in each of Group A, Group B, Group C and Group D form a new Group which consists of four (4) teams. They play for places 13 – 16 in a cross group format:

Day 4

25. 4A - 4B

26. 4C - 4D

27. 2A - 3B

28. 3A - 2B

29. 2C - 3D

30. 3C - 2D

Quarter Final Round:

Day 5

31. Loser Game 25 - Loser Game 26 (Winner 15th, Loser 16th)

32. Winner Game 25 - Winner Game 26 (Winner 13th, Loser 14th)

33. Loser Game 27 - Loser Game 29

34. Loser Game 28 - Loser Game 30

35. 1A - Winner Game 29

36. 1B - Winner Game 30

37. 1C - Winner Game 27

38. 1D - Winner Game 28

Semi-Final Round:

Day 6

- 39. Loser Game 33 - Loser Game (Winner 11th, Loser 12th)
- 40. Winner Game 33 - Winner Game 34 (Winner 9th, Loser 10th)
- 41. Loser Game 35 - Loser Game 36
- 42. Loser Game 37 - Loser Game 38
- 43. Winner Game 35 - Winner Game 36
- 44. Winner Game 37 - Winner Game 38

Final Round:

Day 7

- 45. Loser Game 41 - Loser Game (Winner 7th, Loser 8th)
- 46. Winner Game 41 - Winner Game 42 (Winner 5th, Loser 6th)
- 47. Loser Game 43 - Loser Game 44 (Winner 3rd, Loser 4th)
- 48. Winner Game 43 - Winner Game 44 (Winner 1st, Loser 2nd)

Games 25 through 48 must be played to a conclusion, accordingly it may be necessary to apply the Water Polo Rules relating to penalty shoot-out.

The Management Committee of World Aquatics Competitions may change the order and schedule of games to meet with the requirements of the Host Federation and/or television provided that at least twenty four (24) hours' notice is given.

1.2 World Aquatics Championships - Women**1.2.1 Draw**

The draw for the World Aquatics Championships Tournament will be made two (2) months prior to the commencement of the World Championships Tournament and the following principle shall apply: if a team is already qualified by its ranking from a preceding qualification competition, the team will be placed on the highest line of the draw according to its ranking and the team taking its place will be placed on the lower line.

For the Preliminary Round, all qualifying teams will be drawn into four (4) groups: A, B, C or D.

First Line, the first, second, third and fourth qualified teams from the preceding World Cup or Olympic Games will be drawn one into A, one into B, one into C, and one into D.

Second Line, the qualified teams from the World League (or from the World Cup or Olympic Games if applicable), the first qualified team from the Americas and the first qualified team from Europe will be drawn one into A, one into B, one into C, and one into D.

Third Line, the second qualified team from the Americas, the second and third qualified teams from Europe and the qualified team from Oceania will be drawn one into A, one into B, one into C and one into D.

Fourth Line, the qualified team from Africa, the first and second teams from Asia and the Host Country (if the Host Country has already been drawn, then the next ranked team from the World Cup or Olympic Games) will be drawn one into A, one into B, one into C, and one into D.

After being divided into Groups A, B, C, or D, the teams will then be drawn with each team in each group receiving a separate number from one (1) to four (4).

1.2.2 Schedule of Games

Schedule of Games as in Appendix 9 1.1.2

The Management Committee of World Aquatics Competitions may change the order and schedule of games to meet with the requirements of the Host Federation and/or television provided that at least twenty four (24) hours' notice is given.

1.3 Olympic Games Qualification Tournament - Men

1.3.1 Draw

The draw for the Olympic Games Qualification Tournament will be made two (2) months or as otherwise determined prior to the commencement of the Olympic Games Qualification Tournament.

For the Preliminary Round, all qualifying teams will be drawn by pairs into two groups, either A or B.

First Line, the two highest placed teams from the previous World

Championships.

Second Line, the next two highest placed teams from the previous World Championships.

Third Line, the next two highest placed teams from the previous World Championships.

Fourth Line, the next two highest placed teams from the previous World Championships.

Fifth Line, the remaining teams, if any, from the World Championships or the highest ranked teams from Europe and the next highest ranked teams from the Americas.

Sixth Line, the remaining teams, if any, being the next highest ranked team from the Americas, Asia or Europe and the next highest ranked team from the Americas, Asia or Europe.

Should there be no teams from the previous Championships to seed onto a Line then the highest ranked teams for Europe, Americas, Asia, Africa or Oceania if any, shall be drawn alternating between Group A and Group B.

After being divided into Group A and B, the teams will then be drawn with each team in each group receiving of separate number of 1 to 6.

1.3.2 Schedule of Games

Schedule of Games as in Appendix 9 1.1.2

The Management Committee of World Aquatics Competitions may change the order and schedule of games to meet with the requirements of the Host Federation and/or television provided that at least twenty four (24) hours' notice is given.

1.4 Olympic Games Qualification Tournament - Women

1.4.1 Draw

The draw for the Olympic Games Qualification Tournament will be made two (2) months or as otherwise determined prior to the commencement of the Olympic Games Qualification Tournament.

For the Preliminary Round, all qualifying teams will be drawn by pairs into two groups, either A or B.

First Line, the two highest placed teams from the previous World

Championships.

Second Line, the next two highest placed teams from the previous World Championships.

Third Line, the next two highest placed teams from the previous World Championships.

Fourth Line, the next two highest placed teams from the previous World Championships.

Fifth Line, the remaining teams, if any, from the World Championships and the highest ranked teams from Europe, Americas, Asia, Africa or Oceania.

Sixth Line, the remaining teams, if any, shall be drawn alternating between Groups A and B.

Should there be no teams from the previous Championships to seed onto a Line then the highest ranked teams for Europe, Americas, Asia, Africa or Oceania if any, shall be drawn alternating between Group A and Group B.

After being divided into Group A and Group B, the teams will then be drawn with each team in each group receiving of separate number of 1 to 6.

1.4.2 Schedule of Games

Schedule of Games as in Appendix 9 1.1.2

The Management Committee of World Aquatics Competitions may change the order and schedule of games to meet with the requirements of the Host Federation and/or television provided that at least twenty four (24) hours' notice is given.

1.5 World U20 and U18 Championships – Men and women

1.5.1 Draw

The draw for the World U20 and U18 Championships will be made two (2) months prior to the commencement of the World Championships Tournament and the following principle shall apply: if a team is already qualified by its ranking from a preceding qualification competition, the team will be placed on the highest line of the draw according to its ranking and the team taking its place will be placed on the lower line.

Draw for twenty (20) Teams

The best 8 teams in the ranking from the previous World Championships

(seeding) go in group A and B, and lower 12 teams in 4 groups C,D,E,and F.

1.5.2 Schedule of Games

Schedule for twenty (20) Teams

The best 8 teams in the ranking from the previous World Championships (seeding) go in group A and B, and lower 12 teams in 4 groups C,D,E,and F.

The numbers in the first 3 days are the position in the group after the draw. A and B groups have 4 teams and C,D,E,F groups have 3 teams.

First 3 days A and B group teams they play 3 games (round robin), while C,D,E,F they play 2 games (round robin).

The numbers from the day 4 are the ranking in the groups.

From the ranking of the groups C,D,E,F .the 2nd teams and the 3d teams of the groups C,D,E,F they play in 2 groups (G,H) a mixed round robin the days 4 to 6, and then 7and 8 days for places13-20. 1G-1H (13-14 place) 2G-2H (15-16), 3G-3H (17-18), 4G-4H (19-20)

Day 4, the first teams in the groups C,D,E,F they play against (1D- 1C, 1E-1F) and the losers cross with 3d teams in Group A and B, while the winners cross with 4th teams in Group A and B.

The day 6 the winners of the 4 games they cross with first and seconds of Groups A and B (quarter finals) while the 4 losers they play for 9-12 places the days 7 and 8.

The days 7 and 8 we have semifinals and finals (1- 4 places) and also ranking from 5 to 8 places

The teams will play at least 6 games in the 8 days schedule and for the teams from 13-20 places to be able to play also the 2 last days.

Preliminary Round

Four (4) groups of three (3) teams each from Group C, Group D, Group E and Group F play a single robin round in each group. Upon the the result of the previous World Aquatics World Championships the top eight (8) teams will be drawn into two (2) group of fours (4), Group A and Group B.

| DAY 1 | DAY 2 | SAY 3 |
|----------|-----------|-----------|
| 1. C1-C3 | 9. D2-D3 | 17. E1-E2 |
| 2. D1-D3 | 10. E2-E3 | 18. F1-F2 |
| 3. E1-E3 | 11. F2-F3 | 19. C1-C2 |
| 4. F1-F3 | 12. C2-C3 | 20. D1-D2 |
| 5. A1-A3 | 13. B1-B2 | 21. A2-A3 |
| 6. B1-B3 | 14. A1-A2 | 22. B2-B3 |
| 7. A2-A4 | 15. B3-B4 | 23. A1-A4 |
| 8. B2-B4 | 16. A3-A4 | 24. B1-B4 |

Bye Day 1: C2 D2 E2 F2

Bye Day2 : C1 D1 E1 F1

Bye Day 3: C3 D3 E3 F3

Cross Overs:

The first placed teams in Group A, Group B have a bye.

| DAY 4 | DAY 5 |
|-----------------|------------------|
| 25.2C-3D | 31.2E-2C |
| 26.2E-3F | 32.3F-3D |
| 27.3C-2D | 33.3E-3C |
| 28.3E-2F | 34.2F-2D |
| 29.1D-1C | 35.L29-3A |
| 30.1E-1F | 36.L30-3B |
| | 37.W29-4A |
| | 38.W30-4B |

Bye Day 4: A+B

Bye Day 5: 1A 2A 1B 2B

Quarter Final Round, Semi-Final Round and Final Round

| DAY 6 | DAY 7 | DAY 8 |
|------------------|--------------------------|--------------------------|
| 39. 2C-3F | 47. 4G-4H (19-20) | 55. 2G-2H (15-16) |
| 40. 2E-3D | 48. 3G-3H (17-18) | 56. 1G-1H (13-14) |

| | | |
|-------------------|--------------------|---------------------------|
| 41.3C-2F | 49. L35-L38 | 57.L49-L50 (11-12) |
| 42. 3E-2D | 50.L36-L37 | 58. W49-W50 (9-10) |
| 43. 1A-W38 | 51. L43-L46 | 59. L51-L52 (7-8) |
| 44. 1B-W37 | 52. L44-L45 | 60. W51-W52 (5-6) |
| 45. 2A-W36 | 53. W43-W46 | 61. L53-L54 (3-4) |
| 46. 2B-W35 | 54. W44-W45 | 62. W53-W54 (1-2) |

The Management Committee of World Aquatics Competitions may change the order and schedule of games to meet with the requirements of the Host Federation and/or television provided that at least twenty four (24) hours' notice is given.

| | | | | | |
|----|----|----|----|----|----|
| A1 | B1 | C1 | D1 | E1 | F1 |
| A2 | B2 | C2 | D2 | E2 | F2 |
| A3 | B3 | C3 | D3 | E3 | F3 |
| A4 | B4 | | | | |
| 1 | 2 | 3 | 4 | 5 | |
| 1A | 1B | 1C | 2C | 3C | |
| 2A | 2B | 1D | 2D | 3D | |
| 3A | 3B | 1E | 2E | 3E | |
| 4A | 4B | 1F | 2F | 3F | |

DAY 4,5,6
DAY 7,8 FOR PLACES 13-20

| | |
|-------------|-------------|
| ROUND ROBIN | ROUND ROBIN |
| GROUP G | GROUP H |
| 2C | 3C |
| 3D | 2D |
| 2E | 3E |

| | |
|----|----|
| 1G | 1H |
| 2G | 2H |
| 3G | 3H |

1. Draw for Competitions

The Management Committee for World Aquatics Competitions has the authority if there are only thirteen (13) or fourteen (14) participating teams to

draw teams into two (2) groups rather than being required to draw teams in the prescribed manner for a competition based upon sixteen (16) teams, namely for (4) groups of four (4) teams each.

2. Order of Games

The Management Committee of World Aquatics Competitions may change the order and schedule of games to meet with requirements of the Host

Federation and/or television provided that at least twenty four (24) hours' notice is given.

3. Officials

The Management Committee of World Aquatics Competitions may in addition to other officials appoint the following to assist in the conduct of any competition, namely: a World Aquatics TWPC Delegate, a World Aquatics TWPC Evaluator(s) and Timeout Officials.

4. Tie Breaking rules

General

All matches shall be played in accordance with the World Aquatics' current Competition Rules. Variations on a technical level are possible.

Each game must have a winner. If a game ends with a tie in regular time, the teams must go into a penalty shoot-out according to the Rules.

The matches shall be scored as follows:

- a) win in regular time = 3 points
- b) win after penalty shootout = 2 points
- c) loss after penalty shootout = 1 point
- d) loss in regular = 0 point

Teams' rankings are obtained by adding up the number of points won.

4.1 Tie Breaking Rules, Group phase or Round Robin Tournaments

4.1.1 If two (2) teams shall have equal points, further classification shall be established as follows:

The team winning the game between them (including penalty shoot-out if any) shall be placed higher.

If there is more than one tie in a group, the highest placed tie shall be determined first.

4.1.2 If three (3) or more teams shall have equal points, further classification shall be established as follows:

The results among the tied teams shall determine which team is placed highest.

If, at any time during the application of the procedure, the number of tied teams is reduced to two (2), then the above procedure (1.2.1., tie between two teams) shall be used to determine which of the two (2) remaining teams is placed higher.

The comparison shall be made:

first, upon the points of the games among the tied teams.

second, the goal difference (excluding the goals from penalty shoot-out) among the tied teams,

third, based upon goals scored among tied teams.

If still tied, the games played against the highest placed team (or teams, if tied, the team or teams not involved in the tie) shall be considered.

The first comparison shall be based on goal difference, and if still tied, then based on goals scored.

If still tied, the results against the next highest placed team (or teams, if tied) shall be used in succession until all results have been considered.

If still tied, and there is no practical manner to determine the ranking, the final classification between the teams in the tie shall be decided by coin-toss.

If there is more than one tie in a group, the highest placed tie shall be determined first.

For the purpose of calculating either goal difference or goals scored, the goals in any penalty shoot-out will not be taken into consideration.

PART SEVEN: ARTISTIC SWIMMING RULES

1. GENERAL

All international Artistic Swimming competitions shall be held under World Aquatics Competition Regulations.

2. COMPETITIONS

2.1 Events

The events of Artistic Swimming are Female Solo, Men Solo, Mixed Duet, Team, Free Combination and Acrobatic Routine.

2.1 World Aquatics Championships and Olympic Games Event

2.1.1 Olympic Games

Women

Duet Technical Routine Duet Free Routine

Open

Team Technical Routine Team Free Routine Team Acrobatic Routine

2.1.2 World Aquatics Championships

2.1.2.1 Artistic Swimming - World Aquatics Championships

Women

Solo Technical Routine Solo Free Routine Duet Technical Routine Duet Free Routine

Men

Solo Technical Routine Solo Free Routine Open

Team Technical Routine Team Free Routine Team Acrobatic Routine Free Combination

Mixed

Mixed Duet Technical Routine Mixed Duet Free Routine

2.3 World Aquatics Junior Artistic Swimming Championships

2.3.1 Sessions

The Sessions for World Aquatics Junior Artistic Swimming Championships

will consist of:

Solo Technical, Solo Free, Duet Technical, Duet Free, Mixed Duet Technical, Mixed Duet Free, Team Technical, Team Free and Acrobatic.

2.3.2 Routines

Routines will have preliminary sessions in Technical and Free Routines. All sessions will hold preliminaries in each event and the twelve best routines in each event will move to finals.

2.3.3 All other rules and penalties that apply to World Aquatics Artistic Swimming Championships apply to World Aquatics Junior Artistic Swimming Championships unless otherwise stated.

3. ELIGIBILITY

Athletes in Artistic Swimming younger than fifteen (15) years of age (on December 31st on the year of the competition) shall not be permitted to compete at the Olympic Games, World Aquatics Championships and Artistic Swimming World Cup.

4. SESSIONS

4.1 Figures

Each athlete in Women Solo, Men Solo, Women Duet, Mixed Duet, and Team must perform four (4) or two (2) figures, according to the age group category, as described in the Appendix I of these rules.

Each athlete in Free Combination may perform figures as described in Appendix I of these rules.

The Age Group Figures will be selected by the TASC every four (4) years, subject to approval by the World Aquatics Bureau.

4.2 Technical Routine: Preliminaries / Finals

The Technical Team Routine has four (4) to eight (8) athletes (for the exceptions see Rule VII.6.2). In the Technical Routine each Women Solo, Men Solo, Women Duet, Mixed Duet, and Team must perform the Technical Required Elements described in Appendix II of these rules, a predetermined number of Free Elements (Hybrids and Acrobatics), and a free choice of Transitions (see Appendix III of these rules).

The Technical Required Elements and the number of Free Elements for each event are selected by the TASC every four (4) years, subject to approval by the World Aquatics Bureau.

The Routines are choreographed to music.

4.3 Free Routine: Preliminaries / Finals

The Free Team Routine has four (4) to eight (8) athletes (for the exceptions see Rule VII.6.2). Each Free Women Solo, Men Solo, Women Duet, Mixed Duet, and Team Routine will consist of a predetermined number of Free Elements (Hybrids and Acrobatics) and a free choice of Transitions (see Appendix III of these rules).

The number of Free Elements for each event will be selected by the World Aquatics every four (4) years, subject to approval by the World Aquatics Bureau.

The routines are choreographed to music.

4.4 Free Combination: Preliminary / Final

The Free Combination has four (4) to ten (10) athletes who make a combination of routines.

The Free Combination has a predetermined number of Technical Required Elements and Free Elements (see Appendix 3 of these Rules).

The Routines are choreographed to music.

4.5 Acrobatic Routine: Preliminary / Final

The Acrobatic Routine has four (4) to eight (8) athletes performing a predetermined number of Acrobatic Elements as described in Appendix 3 of these rules.

The Routines are choreographed to music.

5. PROGRAMS

5.1 For Olympic Games

Female Duet Technical and Duet Free routines, Team Technical, Free and Acrobatic routines.

5.2 For World Championships

Technical Routine Preliminary, Technical Routine Final, Free Routine

Preliminary, Acrobatic Routine Preliminary, Free Routine Finals and Acrobatic Routine Final. (Time limits as listed in VII. 14).

5.3 For Artistic Swimming World Cup

Technical Routines, Free Routines, Acrobatic Routines. (Time limits as listed in VII.14), direct finals.

5.4 For World Aquatics Junior Artistic Swimming Championships

Technical Routine Preliminary, Technical Routine Final, Free Routine Preliminary, Acrobatic Routine Preliminary, Free Routine Final and Acrobatic Routine Final. (Time limits as listed in VII.14). The final order of sessions shall be determined by World Aquatics and the Organizing Committee.)

5.5 For World Aquatics Youth Artistic Swimming Championships

Figures and Free Routines in this order: Free Routine Preliminary, Free Combination Preliminary, Figures, Free Routine Final and Free Combination Final (Time limits as listed in ASAG 5). The final order of sessions shall be determined by World Aquatics and the Organizing Committee.

5.6 For all other international competitions

The programme may be any combination of VII.4.1 – VII.4.3 so that the Free Routine is included. The Free Combination is for Youth and 12 & under. The Acrobatic Routine is for Senior and Junior.

6. ENTRIES

6.1 For World Aquatics competitions, each Member Federation shall be entitled to enter one Female Solo, one Male Solo, one Female Duet, one Mixed Duet, one Team Technical, one Team Free, one Free Combination or one Acrobatic Routine (unless otherwise specified).

6.1.1 In World Aquatics Championships, each Member Federation shall be entitled to enter one Technical Solo, one Free Solo, one Technical Male Solo, one Free Male Solo, one Technical Duet, one Free Duet, one Technical Mixed Duet, one Free Mixed Duet, one Technical Team, one Free Team and one Acrobatic Routine.

6.1.2 In World Aquatics Junior Artistic Swimming Championships each Member Federation shall be entitled to enter one Technical Solo, one Free Solo, one Technical Male Solo, one Free Male Solo, one Technical Duet, one Free Duet, one Technical Mixed Duet, one Free

Mixed Duet, one Technical Team, one Free Team and one Acrobatic Routine.

6.1.3 In World Aquatics Youth Artistic Swimming Championships and World Aquatics competitions each Member Federation shall be entitled to enter one Solo, one Male Solo, one Duet, one Mixed Duet, one Team and one Free Combination (unless otherwise specified).

6.1.4 In the Artistic Swimming World Cup, more than one Female Solo, more than one Male Solo, more than one Female Duet, more than one Mixed Duet, more than one Team, and more than one Acrobatic Routine shall be allowed in accordance with the current edition of the Artistic Swimming World Cup Rules and Regulations.

6.1.5 No changes to the entries will be accepted after the GMS sport entries deadline unless on medical grounds. A medical report must be sent to the World Aquatics Office and will be reviewed for approval by the World Aquatics Sports Medicine Committee. A 500.- USD fine will be applied for any non- medical changes after the deadline.

6.2 Team, Free Combination and Acrobatic Routines:

6.2.1 For Olympic Games, Team routines shall consist of eight (8) athletes. The total number of athletes entered by each Federation (unless otherwise specified) may not exceed nine (9) athletes one as reserve. The total number of athletes may include a maximum of two (2) male athletes.

6.2.2 For World Aquatics Championships and World Aquatics Junior Artistic Swimming Championships, team routines shall consist of four (4) to eight (8) athletes and a maximum of two (2) reserves. The total number of athletes may include a maximum of two (2) male athletes.

6.2.3 For World Aquatics Youth Artistic Swimming Championships, Team routines shall consist of at least four (4) but not more than eight (8) and Free Routine Combination shall consist of at least four (4) but not more than ten (10) athletes. The total number of athletes may include a maximum of two (2) male athletes and a maximum of two (2) reserves.

6.3 Entry forms with completed Coach Cards of declared difficulty for each event entered and Music Information sheets must be submitted to the relevant system and/or platform at least fourteen

(14) days prior to the start of the competition. After this date, changes in sport entries will only be accepted on medical grounds. Coach Cards can only be modified between events within four (4) hours of the publication of the preliminaries results. The change is limited to one (1) element. In the case of direct finals, the Coaches Card may be changed within four (4) hours of the publication of the results of the Technical, Free or Acrobatic Routine results.

6.3.1 The entry shall designate the name of the Female Solo and the reserve, the name of the Male Solo and the reserve, the names of the Female Duet athletes and maximum of one reserve, the names of the Mixed Duet athletes and maximum of two reserves, the names of Team athletes and maximum of two reserves, the names of the athletes in Free Combination and maximum of two reserves and/or the names of the athletes in Acrobatic Routine and maximum of two reserves.

For World Aquatics Championships: The maximum quota is fourteen (14). The name of the Technical Female Solo and the reserve, the name of the Free Solo and the reserve, the name of the Technical Male Solo and the reserve, the name of the Free Male Solo and the reserve the names of the Technical Female Duet athletes and maximum of one reserve, the names of the Free Female Duet athletes and maximum of one reserve, the names of the Technical Mixed Duet athletes and maximum of two reserves, the names of the Free Mixed Duet athletes and maximum of two reserves, the names of the Technical Team athletes and maximum of two reserves, the names of the Free Team athletes and maximum of two reserves, and the names of the athletes in the Acrobatic Routine and maximum of two reserves.

For World Aquatics Artistic Swimming World Cup please see its rules and regulations.

7. PRELIMINARIES AND FINALS

7.1 If there are more than twelve (12) entries in any Technical or Free Routine, Free Combination, or Acrobatic Routine, preliminaries shall be held. Only the twelve (12) best results shall be allowed in the official finals.

7.2 If there are less than thirteen (13) entries in any Technical & Free Routine, Free Combination, or Acrobatic Routine, preliminaries may be held.

7.3 This information must be included on the information bulletin (see VII.24.3.7).

8. FIGURE SESSIONS

8.1 Only one Figure session shall be held.

8.2 Athletes in competitions other than World Youth Championships, World Aquatics competitions and continental Championships may, by mutual consent, choose from the Age Group figures (see Appendix 1) for the level of ability of the athletes entered in the competition.

8.3 For the Figure session:

In the 12 and Under-age category each athlete in Female Solo, Male Solo, Female Duet, Mixed Duet, and Team must perform four (4) figures: the two (2) compulsory figures and one (1) group of two (2) figures drawn from the list as described in Appendix I of these rules. Each athlete in 12 and Under Free Combination may perform four (4) figures selected by the above-described procedure.

In the Youth category each athlete in Female Solo, Male Solo, Female Duet, Mixed Duet, and Team must perform a group of two (2) figures from the Section (A, B or C) of figures drawn from the list described in the Appendix I of these rules. Each athlete in Youth Free Combination may perform the two (2) figures selected by the above-described procedure.

8.3.1 Figure section and groups from the World Aquatics Figures 2022-2025 in Appendix I shall be drawn by the Referee/TASC.

8.3.2 The draws shall be made eighteen (18) to seventy-two (72) hours before the start of the Figure session.

8.3.3 The draw shall be public. Place and time shall be announced at least twenty-four (24) hours in advance. Draws can be done over a social media platform.

8.4 In the 12 and Under- category the order of appearance and the figures to be performed by each athlete shall be decided by lot. The Optional group shall be drawn first, then the order of appearance shall be drawn.

In the Youth category, the Figure section (A, B or C) shall be drawn first, then the order of appearance shall be drawn. The order of appearance draw list

will be divided into two equal groups - 1 and 2 (if numbers are not equal, group 1 will have 1 extra athlete). Then one of the two figure groups of the drawn section will be assigned by lot to each athlete group (1 and 2). For example, if Section B is drawn, athlete group 1 may have group 4 drawn, and athlete group 2 may have group 3 drawn.

8.4.1: Each group will have a separate ranking. The two rankings will not be combined.

8.5 Swimwear for the figure session must be according to Rule I.7, it shall be black, and athletes shall wear white caps. Goggles and nose clips may be worn. Only small stud jewellery is permitted. Athletes must remove any dangling jewellery prior to the start of the event.

9. FIGURE PANELS

9.1 When qualified judges are available in sufficient numbers one (1), two (2) or four (4) panels of six (6) or seven (7) judges may officiate.

9.1.1 When one (1) panel of judges is used, all athletes shall perform the four (4) or two (2) figures (according to age category) one by one in the listed order.

9.1.2 When two (2) panels of judges are officiating, each panel shall judge one (1) or two (2) figures.

9.1.3 When four (4) panels of judges are officiating, each panel shall judge one (1) figure.

9.2 During the Figure session, the judges shall be placed in such elevated positions as to have a profile view of the athletes.

9.2.1 All figures and judging shall commence at a signal from the Referee or Assistant Referee.

9.2.2 On a signal from the Referee or Assistant Referee all judges shall simultaneously flash their score.

9.2.3 Judges scores may only be flashed on the score board or be sent to the computer after approval by the Referee or the appointed official.

10. JUDGEMENT OF FIGURES

10.1 The athlete can obtain points from 0 – 10 using 1/10th points.

| | | | |
|--------------|-----------|---------------------|-----------|
| Perfect | 10 | Satisfactory | 5.9 – 5.0 |
| Near perfect | 9.9 – 9.5 | Deficient | 4.9 – 4.0 |
| Excellent | 9.4 – 9.0 | Weak | 3.9 – 3.0 |
| Very Good | 8.9 – 8.0 | Very weak | 2.9 – 2.0 |
| Good | 7.9 – 7.0 | Hardly recognizable | 1.9 – 0.1 |
| Competent | 6.9 – 6.0 | Completely failed | 0 |

10.2 All judgements are made from the standpoint of perfection considering design and control, with each transition of the figure having a numerical value (NVT) based on its difficulty.

10.3 If a judge by reason of illness or other unforeseen circumstances has made no award for any one figure, the average of the awards of the other five (5) or six (6) judges shall be computed and shall be considered as that of the missing award. This shall be calculated to the nearest 0.1 point.

11. PENALTIES IN FIGURE SESSION

11.1 If an athlete does not perform the announced figure, or if the figure does not have all the required elements or is performed other than according to the description, the Referee or Assistant Referee shall advise the judges and the athlete that the result of the figure will be a zero.

11.2 In Figure competition, if the award for the figure is a zero the Referee may review the official video together with two (2) World Aquatics Evaluators or World Aquatics Judges (ensuring that three different Federations are represented) a maximum of three (3) times. If a definite decision cannot be reached after three (3) reviews, it shall be awarded in the athlete's favour (no zero will be applied).

11.3 In a Figure competition for the 12 and Under-age category, if the athlete doesn't perform the correct figure, the athlete will be allowed to perform this figure again and a 1-point penalty will be applied. If the athlete fails again, then "O" will be applied.

12. CALCULATION OF THE FIGURE RESULT

12.1 The highest and the lowest awards are cancelled (one of each). The four (4) or five (5) awards are added, the sum divided by four (4) or five (5). The result is multiplied by the degree of difficulty to obtain the score for each of the four (4) or two (2) figures competed.

12.2 The sum of the four (4) or two (2) figures shall be divided by the total degree of difficulty of the figures competed and multiplied by 10, and then the penalties shall be deducted.

12.3 The figure result shall be:

12.3.1 For Solo the result shall be obtained according to VII.12.2.

12.3.2 For Duets– for each athlete the result shall be obtained according to VII.12.2. These results shall be added, and the total divided by two (2) to determine the average score (round off to the fourth decimal places) for the routine.

12.3.3 For Teams – for each athlete who competes in a team routine the result shall be obtained according to VII.12.2. These results shall be added, and the total divided by the number of athletes in the team to determine the average score (round off to the fourth decimal places) for the routine.

12.3.4 If an athlete after the preliminaries in Duet or Team is not able to compete in the Figures session (due to illness or injury), in Duet the figure score of the reserve is used to determine the total score for the duet: In Team, the higher figure score of the two (2) reserves is used to determine the total score for the Team routine.

13. ROUTINE SESSIONS

13.1 A Mixed Duet shall consist of one female and one male.

13.2 A team shall consist of at least four (4) but not more than eight (8) athletes (for the exceptions, see VII.6.2). The number of team athletes may not change between Preliminary and Finals or Technical and Free Routines. The total number of athletes may include a maximum of 2 male athletes.

13.3 A Free Combination shall consist of at least four (4) but not more than ten (10) athletes. The total number of athletes may include a

maximum of 2 male athletes.

13.4 An Acrobatic Routine shall consist of four (4) to eight (8) athletes. The total number of competitors may include a maximum of 2 male athletes.

13.5 In Free Combination and Acrobatic Routines the number of athletes may not change between Preliminary and Finals.

13.6 In Duet, Mixed Duet, Team, Free Combination and Acrobatic Routine events athletes who are listed on the entry according to rule VII.6.3.1 may be interchanged before routine sessions.

13.6.1 Any changes of the names of the athletes from the most recent entry lists must be handed to the Referee in writing at least two (2) hours prior to the published start time of routine number one. This time must be published in the official competition schedule. Changes after this can only be made in case of sudden illness or accident of an athlete and if the reserve is ready to compete without delaying the competition. The final decision in such a situation shall be made by the Referee.

13.6.2 If the lack of the reserve reduces the Team, Free Combination or Acrobatic Routine size to less than that defined in VII.4.4, VII.4.5, VII.6.2, VII.13.2, VII.13.3 or VII.13.4, the team shall be disqualified.

13.6.3 Failure to notify the substitution and / or scratching according to rule VII.13.6.1 shall result in disqualification of the routine.

13.7 Draw Procedure for Technical Routines, Free Routine Preliminaries, Free Combination Preliminaries or Acrobatic Routine Preliminaries (WAC and OG)

All routine events shall be entered according to the World Ranking. Draws will be divided into two parts: athletes with a current World Ranking and those without a World Ranking.

Draw Process for Non-Ranked Athletes

The non-ranked athletes will be randomly drawn into start order groups of 6. These groups will compete first in the competition in the drawn order and before the lowest group of ranked athletes.

Draw Process for World Ranked Athletes

Athletes with World Rankings will compete in the draw following the non-ranked athletes, in reverse order of ranking with the highest ranked athlete competing last, followed by the next ranked athlete, etc. In cases of ties in the World Rankings, there will be a separate draw between tied athletes to decide the order of the main draw.

21 Example: 30 entries in World Aquatics Championship Technical Duet – 18 ranked duets and 12 non-ranked duets. Draw Procedure: non-ranked duets will draw for start order 1-12 based on a random draw; ranked duets will compete in reverse order in 13-30 based on world rank order.

Refer to Appendix 9 for World Ranking Information.

13.7.1 The draw shall be manual if no World Aquatics sanctioned electronic draw system is available. The draw shall take place at least eighteen (18) hours before the first part of the competition and shall be public. Place and time shall be announced at least twenty-four (24) hours in advance.

13.7.2 The order of the draw shall be Teams, Free Combination, Acrobatic Routine, Duets and Solo Preliminaries. For competitions involving both Technical and Free Routines, the draw for the event's Technical Routine shall first be held followed by the Free Routine Draw (Team Technical, Team Free Preliminary, Free Combination Preliminary, Acrobatic Routine Preliminary, Duet Technical, Duet Free Preliminary, Mixed Duet Technical, Mixed Duet Free Preliminary, Solo Technical, Solo Free Preliminary, Male Solo Technical and Male Solo Free Preliminary).

13.7.3 When a Federation draws start number one (1) in a Technical Routine or Free Routine Preliminary, Free Combination Preliminary or Acrobatic Routine Preliminary, or Direct Finals, this Member Federation shall be exempt from start number one (1) in all remaining Preliminary or direct final sessions in the family the Member Federation drew first in. (Example Solo family includes Technical and Free Routines for Female Solo and Male Solo).

13.8 After the Figures and/or Technical Routines and Free Routines Preliminaries and Combination/Acrobatic Routine Preliminaries the first twelve (12) by total score shall compete in the finals.

If the number of participants in preliminaries is higher than 35, the first fourteen (14) by total score shall compete in the finals.

Exception: In World Aquatics (Senior) Championships: after each Technical / Free Routine / Acrobatic Routine, the twelve (12) best will compete in the respective Final.

13.8.1 The order of appearance in Finals will be divided into draw groups of 6 or 7 athletes. Those athletes who placed 1-6 or 1-7 per VII.13.8 shall draw for the last start numbers; those athletes who placed 7-12 or 8-14, shall draw for the first start numbers. If the number of athletes in Finals is not divisible equally, the first group to swim will be the smallest group.

13.9 Theatrical make-up shall not be worn. Natural makeup that represents the athlete's unique personality and/or the theme of their routines may be used.

13.10 The use of accessory equipment, goggles or additional clothing is not permitted unless required by medical reasons. In the event that the Referee observes or is informed by Assistant Referee that the athlete(s) does not conform, the athlete will not be permitted to compete until in conformance.

13.11 Nose clips or plugs may be worn.

13.12 For safety reasons only small stud jewelry is permitted. Athletes must remove any dangling jewelry, or dangling items from headpieces or swimwear prior to the start of the event.

13.13 In routines the swimwear must conform to I.7 and VII. 13.9.-13.13. In the event that the Referee thinks the athlete(s) swimwear does not conform, the athlete will not be permitted to compete until in conformance. Swimsuits may however represent character or theme of the music they are swimming to. The swimsuits must not give the effect of excessive nudity inappropriate for the discipline. Artistic Swimming Suits must be dignified and appropriate for athletic competition.

14. TIME LIMITS FOR ROUTINES

14.1 Time limits for Technical Routines, Free Routines and Acrobatic Routines including ten (10) seconds for deck movement:

14.1.1 Technical Routine Female Solos: 2 minutes 00 seconds

Technical Routine Male Solos:

Free Routine Female Solos: 2 minutes 15 seconds

Free Routine Male Solos:

14.1.2 Technical Routine Duets: 2 minutes 20 seconds

Free Routine Duets: 2 minutes 45 seconds

14.1.3 Technical Routine Mixed Duets: 2 minutes 20 seconds

Free Routine Mixed Duets: 2 minutes 45 seconds

14.1.4 Technical Routine Teams: 2 minutes 50 seconds

Free Routine Teams: 3 minutes 30 seconds

14.1.5 Acrobatic Routine: 3 minutes 00 seconds

14.1.6 There shall be an allowance of five (5) seconds less or plus the allotted time for all routines.

14.1.7 In all routine events, the walk-on of the athletes from the designated starting point to the achievement of a stationary position(s) may not exceed 30 seconds for Technical and Free Mixed Duets, Technical and Free Teams, and Free Combination and Acrobatic Routine and may not exceed 20 seconds for any Male and Female Solo and Female Duet Events

14.1.8 In routine events, when the routine starts in the water, the time allowance for the athletes to achieve a stationary starting position in the water shall not exceed 30 seconds for Technical and Free Mixed Duets, Technical and Free Teams, Free Combination and Acrobatic Routines and may not exceed 20 seconds for any Male and Female Solo and Female Duets Events.

14.1.9 Age Group time limits – see Artistic Swimming Age Group 5.

14.2 Timing of the performance shall start with the walk-on and finish with the accompaniment. Timing of the walk-on shall commence when the first athlete moves past the designated starting point and ends when the last athlete assumes a starting position. Timing of the deck movements shall begin with the accompaniment and end as the last athlete leaves the deck.

14.3 The accompaniment shall begin upon a signal from the Referee or appointed official. After the signal the athlete(s) must perform the routine without interruption (see VII. 18.2). Routines may start on the deck or in the water, but they must finish in the water.

14.4 The Timer shall check the overall time of the deck movements and the walk- on. If the time limit is exceeded for the deck movements, walk-on or there is a deviation from the routine time limit allowance (see VII.14.1) the Timer or Sound Center Manager shall advise the Referee, or the appointed official designated by the Referee.

14.5 All Athletes shall provide music in accordance with the quality requirements of each Organising Committee as stated in the bulletin. Organisers may request new music should it not meet the standards required. Team managers will provide on the registration form the exact running time of the music, not swimming time, which shall be signed off on at the team managers meeting for each routine. The official time will be reviewed by the Sound Center Manager's electronic running time. The Sound Center Manager will notify the Referee of any music that does not comply with AS timing rules.

14.6 If there is no official training with music, the organizer must provide the athlete or Team Leader the opportunity to hear their music in the competition venue prior to the start of the event.

15. MUSIC ACCOMPANIMENTS

15.1 The Sound Center Manager shall be responsible for the securing and properly presenting the accompaniment for each routine.

15.2 For World Aquatics competitions, a decibel (sound level) meter shall be used to monitor the sound level and ensure that no person is

exposed to average sound levels exceeding 90 decibels (rms) or momentary peak sound levels exceeding 100 decibels.

15.3 Team Managers are responsible for submitting their music electronically via the Internet to the Sound Center Manager according to the instructions in the bulletin at least 14 days prior to the start of practice sessions. Each submission shall be labelled as to event, name of the athletes and national Federation.

The organizing committee must supply a World Aquatics approved music system in the competition pool and have a second sound system in the practice pool.

16. ROUTINE PANELS

16.1 Two (2) panels of five (5) judges must officiate in all routines: one for Elements and one for Artistic Impression.

Two (2) groups of three (3) Technical Controllers must officiate in all routines: one group to check the number, order of performance and predeclared difficulty of the Free Elements (Hybrids and Acrobatics), and the performance and predeclared order of Technical Required Elements (technical routines), and one group to register the number and type of synchronisation errors observed.

16.1.1 There will be one (1) Difficulty Technical Controller (DTC) and two (2) Difficulty Assistant Technical Controllers (DATC). The purpose of the role is to verify all of the Technical Required Elements (technical routines), and the Free Elements (Hybrids and Acrobatics) performed in real time as they occur in a routine. They are also responsible for the identification of any "technical errors", which are differences in what is declared on the Coach Card to what is performed in the water OR an error in a Technical Required Element (technical routines). The Difficulty Technical Controller will have communication to the Referee.

16.1.2 There will be three (3) Synchronisation Technical Controllers (STC) who will record the number of synchronisation errors (unequal actions) they observe during the performance of a routine. They will be seated on deck with a clear view of the pool.

16.2 During routine sessions the Judges, Evaluators and Synchronisation Controllers shall be placed in elevated positions on

opposite sides of the pool.

16.3 At the completion of each routine the Judges submit their scores.

16.4 If one or more Judges by reason of illness or other unforeseen circumstances has made no award for a routine, the average of the awards of the other judges shall be computed and shall be considered as the award. This shall be calculated to the nearest 0.25 point.

16.4.1 If an unexpected situation happens during a session and one or more Judges cannot give an award for a routine, the Referee can disrupt the session and performance. After the settlement of a matter and safe confirmation, the Referee shall resume the session and allow the athlete to swim again.

16.5 Judges' scores will be displayed on the score board after approval from the Referee. Judges' scores cannot be changed after being posted on the scoreboard.

16.6 For all Routines, official(s) will be appointed by the Referee & World Aquatics Delegate/Commission to monitor the use of the bottom of the pool.

17. JUDGEMENT OF ROUTINES

17.1 In Routines, the athlete can obtain points from 0 – 10 using 0.25 points.

| | |
|--------------|------------|
| Perfect | 10 |
| Near perfect | 9.75 – 9.5 |
| Excellent | 9.25 – 9.0 |
| Very Good | 8.75 – 8.0 |
| Good | 7.75 – 7.0 |
| Competent | 6.75 – 6.0 |
| Satisfactory | 5.75 – 5.0 |
| Deficient | 4.75 – 4.0 |
| Weak | 3.75 – 3.0 |

| | |
|---------------------|-------------|
| Very weak | 2.75 – 2.0 |
| Hardly recognizable | 1.75 – 0.25 |
| Completely failed | 0 |

17.2 In all Routines each Judge shall award scores from 0-10 points each (see VII.17.1).

Elements panel judges shall award one (1) score for the execution of each Element (Free and Technical Required).

Artistic Impression panel judges shall award three (3) scores, one (1) score for choreography and musicality, one (1) score for performance and one (1) score for transitions.

Difficulty Technical Controllers check the predeclared difficulty on the submitted Coach Card. Difficulty values can be found in Appendixes VI and VII and Coach Card format in Appendix VIII of these Rules. World Aquatics reserves the right to adjust the components assigned to each category as required.

17.2.1 First panel – ELEMENTS

In **EXECUTION** consider: the level of excellence in performing highly specialized skills. Execution of all routine Elements: Technical Required Elements and Free Elements (Hybrids and Acrobatics)

17.2.2 Second panel – ARTISTIC IMPRESSION

In **CHOREOGRAPHY** and **MUSICALITY** consider the creative skill of composing a routine that combines artistic and technical elements. The design and weaving together of variety, creativity, and innovation of all movements including elements and transitions. The pool coverage. Expressing the mood of the music, use of the music's structure and the movements and synchronisation with the music.

In **PERFORMANCE** consider the manner in which the athlete(s) present(s) the routine to the viewers including the walk-on and deck movements. The use of body language to express physical and emotional power, confidence, and total command of the performance.

In **TRANSITIONS** consider the artistry and mastery of varied and purposeful movements, propulsions and strokes that link routine elements.

18. DEDUCTION, PENALTIES AND OTHER MATTERS IN ROUTINES

18.1 In Technical, Free and Acrobatic Routines one half (0.5) point penalty shall be deducted from the total score for each athlete less than eight (8) (see VII.13.2 and VII.13.4).

18.2 If one (or more) athlete(s) stops swimming or makes clear support use of the pool wall before the routine is completed, the routine will be disqualified. The Referee shall assess if the cessation is caused by circumstances beyond the control of the athlete(s). The Referee may allow the routine to be re-swum during the session.

18.3 Penalties in Free Routine, Technical Routine, Free Combination and Acrobatic Routine

All Free Elements (Hybrids and Acrobatics) have a calculated **Base Mark (Appendix VI and VII)** that is the minimum Degree of Difficulty that will be applied if one (1) or more components of the element is not performed or is not in conformance to what is declared in the Coach Card. In the case of detected error(s) of declared calculation of the Base Mark, the DTC will recalculate.

A one (1) point penalty shall be deducted from the **routine** score if:

18.3.1 The time limit of ten (10) seconds for deck movements is exceeded.

18.3.2 There is a deviation from the specified routine time limit allowed (less or more than) for the routine and in accordance with VII.14.1 and ASAG 5.

18.3.3 If the time limit of 20/30 seconds for the deck walk-on is exceeded.

18.3.4 A two (2) point penalty shall be deducted from the routine score if:

18.3.5 An athlete has made deliberate use of the bottom of the pool during a routine to propel themselves or to assist another athlete. No penalty will be applied when the contact with the bottom of the pool results from the swimmer's self-protection from injuries by impact.

18.3.6 A routine is interrupted by an athlete during the deck movements and a new start is allowed.

18.4 In all routines, a two (2)-point penalty shall be deducted from the **Elements** score for each element exceeding the predetermined number assigned to the particular event and category.

18.5 In Free Mixed Duet and World Aquatics Youth Team events a half (0.5) point penalty shall be deducted from the Artistic Impression score for each of the additional required movements in Appendix III not performed (Two (2) surface connected movements with travel in Mixed Duet; one (1) Thrust (T1-T9) and one (1) Spin descending 720° with one or two legs (R3) in Youth Team).

18.6 For all routines, the sum of all synchronisation errors (unequal actions) observed by the Synchronisation Technical Controllers (STC), (each factored by its assigned value) will be deducted from the **Elements** Score.

Types of Synchronisation errors and penalty values:

Small: 0.1 points

Obvious: 0.5 points

Major: 3.0 points

The description of small, obvious, and major synchronisation errors (unequal actions) is detailed in the World Aquatics Artistic Swimming Manual for Routines. Maximum deduction can reduce the Elements score to zero, but not to a negative Elements score.

18.7 Penalties and other matters in Technical Routines

18.7.1 In a Technical Routine, if one (1) or more athletes omit all or part of an Element or performs an incorrect action in a Technical Required Element, the Difficulty Technical Controllers shall make note that the declared movement was not correct. If the video review confirms (review performed by three neutral parties) a zero (0) will be assigned as the Degree of Difficulty for this particular Element.

18.7.2 The Difficulty Technical Controller (DTC) shall inform the Scorer to submit a zero (0) for each Technical Required Element #1 to #5 swum out of the order declared on the Coach Card (each violation of General Requirement #4 in Appendix 2).

18.7.3 A half-point (0.5) penalty shall be deducted from the **Elements** Score for **each violation of** General Requirements #6 in Appendix 2.

18.7.4 A two (2) point penalty shall be deducted from the **Elements Score** for each violation of routine requirement # 6 of Solo, Duet, Mixed Duet and Team, and requirement #7 of Team in Appendix 2.

18.8 Penalties in Free Combination

18.8.1 A two (2) point penalty shall be deducted from the **Routine Score** for violations of each General Requirement #, 3, 4, 5 and 6 in Appendix 5.

18.8.2 A two (2) point penalty shall be deducted from the **Elements Score** for each violation of the Technical Required Elements #1 and #2 in the Appendix 5.

18.9 Penalties in Acrobatic Routine

18.9.1 A two (2) point penalty shall be deducted from the **Routine Score** for each violation of General Requirement #3 in Appendix 4.

18.9.2 A two (2) point penalty shall be deducted from the **Elements Score** for each Required Acrobatic not performed or not conforming to the Acrobatics groups specified in Appendix 4.

18.10 Technical Controller (DTC/DATC/STC) Review Request

The World Aquatics Delegate/Commission shall appoint three (3) members which may include themselves for a Jury of Review to review a decision of the Technical Controllers (DTC/DATC/STC). To avoid either actual bias and prejudice or the appearance of bias, members appointed to the Jury of Review shall not be members of the Federation requesting the review. Persons who are biased and prejudice shall be disqualified from the Jury Panel Review. The Jury of Review shall be appointed as soon as the World Aquatics Delegate is informed of the request to review a decision taken by the Technical Controllers (DTC/DATC/STC).

Process:

The Team Leader must file a request for review of a routine for Technical Controller (DTC/DATC/STC) decisions to the World Aquatics Delegate within thirty (30) minutes after results publication.

All review requests must be submitted in writing on the World Aquatics Technical Controller Review Application Form by the responsible Team Leader.

The Review Panel will decide on the location and the review format of the routine.

The Team Leader/Coach/Athlete may be present for the review. If a video has to be reviewed more than three (3) times the ruling will go in favour of the athlete. The Review Panel is required to respect the confidentiality of the appeal until the decision is made public, and to consult with only members of the Review Panel.

Decisions of the Review Panel may be announced verbally at the conclusion of the review. The Review Panel shall submit the decisions and reasoning to World Aquatics in writing which will be shared with the Federation. A record of the written decision will be stored at the World Aquatics office. The decision of the Jury of Review is final.

19. CALCULATION OF THE ROUTINE RESULTS

19.1 Calculation procedure for all routines:

$EL1DD * Ex + EL2DD * Ex + \dots + ELnDD * Ex - Sy \text{ errors penalty} - \text{other penalties}$

= Elements score

$CH/MU \text{ score} + P \text{ score} + Tr - \text{other penalties}$

= Artistic Impression score

$\text{Elements score} + \text{Artistic Impression score} - \text{other penalties}$

= Routine score

The score for each element is calculated as follows: the highest and the lowest awards for each score are cancelled (one high, one low). The three (3) remaining awards are added, and the sum divided by three (3). The result is multiplied by its correspondent DD.

For each of the three (3) Artistic Impression scores the highest and the lowest awards for each score are cancelled (one high, one low). The three (3) remaining awards are added.

EL = Element (either required or free)

DD = Sum of values of each element component and bonuses + Base Mark for Free Elements (all in Hybrid Difficulty Table); assigned DD for Technical Required Elements #1 to #5

Ex = Execution score

n = Total number of Elements in an event (see Appendix III)

CH/MU = Choreography and Musicality n results is the EP = Performance

Tr = Transitions

**World Aquatics will manage all final DD values. Factoring can be applied.
World Aquatics reserves the right to adjust if required**

19.2 The Routine Score shall be the sum of the Elements score and Artistic Impression scores less any penalty deductions in VII.18.

20. FINAL RESULT

20.1 The final Figure result shall be that of the athletes who actually swam the Free Routine. For exceptions see rule VII. 12.3.4.

20.2 The final result is determined by adding the final score of each performed session; if both Preliminary and Final Routine sessions are held, the Routine score from the Final session shall replace that of the Preliminary session to determine the Final result.

20.2.1 In events that include one (1) session – Acrobatic Routine or Free Combination, Free Routine, Technical Routine or Figures – the result shall be the score of that session.

20.2.2 In events that include two (2) sessions – Figures and Free Routine or Technical Routine and Free Routine – the results shall be the sum of each session.

20.2.3 In events that include three (3) sessions – Technical Routine, Free Routine and Acrobatic Routine– the results shall be the sum of each session.

20.3 In the case of ties (calculated to four (4) decimals) in Female Solo, Male Solo, Duet, Mixed Duet, Team, Free Combination and Acrobatic Routine, the following shall apply.

If a decision has to be made to go to finals or draws, to be qualified, or to be promoted/ demoted, the following procedure will be used:

For all routines:

The highest Elements score shall decide. If there is still a tie, the highest Choreography and Musicality score in the Artistic Impression panel determines the position.

If there is still a tie, the highest verified total declared degree of difficulty in the Elements panel will decide.

For events with combined results (Technical, Free and Acrobatic Routines)

Example: Olympic Games, the following procedure will be used:

The higher Free Routine score of the final result shall decide.

If there is still a tie, the Elements score of the Free Routine determines the position.

If there is still a tie, the highest Choreography and Musicality score in the Artistic Impression panel of the Free Routine determines the position.

If there is still a tie, the highest Elements score from the Technical Routine shall decide.

21. OFFICIALS AND DUTIES

21.1 Officials shall be recommended by World Aquatics. The evaluations of the Judges, their overall world ranking, bias scores, and participation in World Aquatics events in the past two (2) seasons will be considered. Continental representation will be considered, in selecting Judges, however the best Judges will be placed on final events. These selections shall be final except for emergency situations (see VII.22.3 and VII.22.4).

21.2 The required officials shall be:

21.2.1 A Referee

21.2.2 One Assistant Referee for each panel of Judges in figures competitions.

21.2.3 For World Aquatics events and Olympic Games one (1) Difficulty Technical Controller (DTC) and two assistant (2) Technical Controllers (DATC) are required.

21.2.4 For World Aquatics events and Olympic Games three (3) Synchronisation Technical Controllers (STC) are required.

21.2.5 Each Figure panel shall consist of six (6) or seven (7) Judges. In Routines two (2) panels of five (5) Judges shall be used. At World Aquatics competitions and Olympic Games, Judges shall be chosen from the World Aquatics lists of Judges, Technical Controllers shall be selected from the list of World Aquatics Technical Controller experts.

21.2.6 For each Figure panel – a Panel Referee, a Panel Marshall and

two (2) to three (3) scorers.

21.2.7 For routines – one (1) timer and one (1) Referee

21.2.8 A World Aquatics approved Sound Center Manager

21.2.9 A World Aquatics approved announcer

21.2.10 A World Aquatics approved Under Water Camera Operator.

21.2.11 A World Aquatics approved Video Replay System for Technical Controllers

21.2.12 Two (2) appointed World Aquatics Evaluators. shall be selected from the trained group of World Aquatics Evaluators.

21.2.13 Other officials as deemed necessary

22. REFEREE

22.1 The Referee in collaboration with the World Aquatics Delegate or Commission and Evaluators shall have control of the event. The Referee shall enforce the decisions of the group. Referees will take attendance and provide the judges with logistic information for the session (for example if there is break or if there are any scratches). The Evaluators will lead all Judge panel discussions and Judge debriefs.

The Referee shall be responsible for:

- Draw for order of appearance in all sessions.
- Recording changes of athletes prior to each session.
- Checking the electronic scoring system.
- Checking the computer results.
- Ensure that an evaluators program is provided.
- Ensure Coaches cards have been uploaded for the Technical Controllers
- Ensure Judges have list of performance of Elements for each routine.
- Be in communication with the Announcer, Medical personel, Sound Center Manager, lifeguards and Assistant Referee.

- Receive Coaches Card changes and ensure distributed to Scorer, Technical Controllers, Announcer, media and broadcast.

22.2 The Referee shall be responsible for the running of the deck and flow of the event. Rules will be enforced by the Referee after collaboration with the World Aquatics Delegate/Commission. The Evaluators may be consulted as necessary. The Referee in collaboration with the World Aquatics Delegate/Commission are responsible for questions and decisions of the events relating to the conduct of the event.

22.3 The Referee shall ensure that all the necessary officials are in their respective positions to conduct the session. They ensure the officials have their assignments for each routine and are provided with a list of performance of Elements for each routine.

22.4 The Referee may appoint reserve Judges for any persons who are absent, incapable of acting or found to be inefficient or biased after consultation with the World Aquatics Commission/Delegate.

22.5 In emergencies, the Referee is authorized to assign a reserve Judge.

22.6 Referees ensure that the athletes are ready and signal for the start of the accompaniment. They shall approve the penalties resulting from any infraction to the rules. The Referee and World Aquatics Delegate/Commission shall approve the results before announcements.

22.7 The Referee may intervene in the event at any stage to ensure that the World Aquatics regulations are observed and shall adjudicate all protests in collaboration with the World Aquatics Delegate/Commission related to the session in progress.

22.8 The Referee shall recommend disqualification of any athlete for any violation of the rules that they personally observe by reporting the offender to the World Aquatics Delegate/Commission.

22.9 The Referee must attend the Team Leaders meeting and ensure logistics for the event are in place.

22.10 The Referee runs the draws at the Team Leaders' meetings. Draws will commence after all media information sheets have been submitted to the LOC on each routine.

22.11 The Referee ensures World Aquatics has set up chat groups with the coaches group at the Team Leaders meeting and officials' groups at the Judges meeting.

23. OTHER OFFICIALS

23.1 Other official(s) shall carry out duties assigned by the Referee.

24. DUTIES OF ORGANIZER

24.1 The Member Federation holding the competition is responsible for:

24.1.1 Pool specifications and related regulations listed in rules VII.27.1-4. Changes to requirements must be approved by World Aquatics.

24.1.2 Providing suitable sound equipment approved by World Aquatics.

24.1.3 Providing four (4) underwater speakers for competition pool and four (4) underwater speakers for the practice pool.

24.1.4 Providing list of performance of Elements for each routine for Judges and Coach Cards.

24.1.5 Preparing a list of entries and judging forms.

24.1.6 Providing event information electronically to TASC, Officials, Coaches, media and VIPs.

24.1.7 Providing the Judges for figure sessions with a means of signalling scores. When automatic Officiating Equipment is used, each Judge shall be provided with flash cards in case of technical failure.

24.1.8 Ensuring a World Aquatics approved scoring system is used.

24.1.9 Ensuring that electronic marks and display/scoreboard is be used for World Aquatics events. The results display information score board must show placing in previous program (Preliminaries or Technical Routine) and current placing in current program (Finals or Free Routine) and an overall current placement.

24.1.10 Ensuring that video records of all sessions and underwater video is available if required for all routines to enable checking the use of the bottom of the pool.

24.2 The information bulletins for all Artistic Swimming competitions must include the following information:

- The place of the event and the name of the pool
- The date and time of the competition when it is held
- Names of World Aquatics President, World Aquatics Staff, World Aquatics Delegate/Commission, World Aquatics Bureau Liaison
- List of Federations participating by event entries
- Event schedule
- Transportation schedule for athletes, officials and TASC. The schedule will be posted at the venue and in the lobby of the hotels
- Officials participating in the event
- Pool dimensions with specific reference to the depth of the water, the water level below deck, position of diving boards, ladders, etc. A cross section drawing of the pool is desirable, and diagrams of the pools for figure session and routine sessions. In case the pool specifications are not according to Facilities Rules 10, diagrams and cross section drawing are obligatory and must be sent with the meet invitation.
- Temperature of water
- Gel station for athletes / Mirrors for athletes
- Stretch room for athletes
- Lockers for Judges
- Practice pool that mimics competition pool with platform
- Training schedules ensuring all athletes have equal conditions
- Transportation schedules for pick up and departure to airport
- Assistance with local visa/ covid requirements
- Link to live streaming and results

- Medical Services Information

24.3 Other duties:

24.3.1 Markings of bottom and sides of the pool.

24.3.2 Position of audience with reference to the pool and designated VIP seating area.

24.3.3 Type of lighting

24.3.4 Open space for entrance and exit, to include designated starting point for walk-ons.

24.3.5 Types of sound equipment available.

24.3.6 Alternative facilities, if required.

24.3.7 Schedule of events, indicating which sessions (per VII.4) will be included in the program (VII.5) and stating whether Preliminaries and Finals will be held according to VII.7.1 and VII.7.2.

24.3.8 Ensure Gala water show is included at the end of the competition. Participating athletes must perform a new routine of no less than 1:00 minute and no longer than 1:30 minute in duration. Costumes, make up props and lighting are welcome. Gala Show program must be approved by World Aquatics

25. AGE GROUP RULES**25.1 General**

World Aquatics Rules of competition will apply in all Age Group competitions.

25.2 Age Categories

25.2.1 All Age Group athletes remain qualified from 1st January to the following 31 December at the age they are at the close of day (23:59) on 31st

December of the year of the competition.

25.2.2 Age Groupings for Artistic Swimming are:

- 12 years of age and under
- Youth (13 - 15 years of age)

- Junior (15-19 years of age)
- Senior 15 +above

25.2.3 Male Age Groupings for Artistic Swimming are:

- 12 years of age and under
- Youth (13 – 16 years of age)
- Junior (15 - 20 years of age)
- Senior 15 + above

25.3 Age Group figure sessions

25.3.1 In the 12 & Under age category, each athlete in Female Solo, Male Solo, Duet, Mixed Duet, and Team must perform four (4) figures: the two (2) compulsory figures and one (1) group of two (2) figures drawn from the list described in the Appendix I of these rules. Each athlete in Free Combination may perform four (4) figures selected by the above-described procedure.

In the Youth category, each athlete in Female Solo, Male Solo, Duet, Mixed Duet, and Team must perform a group of two (2) figures from the set of four (4) figures drawn from the list described in Appendix 5 of these rules. Each athlete in Free Combination may perform the two (2) figures selected by the above-described procedure.

A group or set of two (2) groups of Figures from the World Aquatics Figures 2022-2025 in Appendix I shall be drawn by the Organising Committee according to VII.8.3.

25.3.2 Figure lists:

The figure groups for 12 & Under and the 3 sets of 2 groups of figures with 2 figures in each group with identical DD for Youth age groups are listed in Appendix I of these World Aquatics Artistic Swimming Rules. Participating Federations/Clubs may also by mutual consent choose from other Age Group for the level of ability of the athletes entered in the competition.

25.3.3 For each athlete in 12 & Under and Youth age groups the final result of the figures session will be divided by the total degree of difficulty of the figures performed and multiplied by 10 (see VII.12.2).

25.4 In a Duet, or Team event of the 12 & Under and Youth age

categories, all athletes must compete in their own Age Group and must swim the Figure groups assigned by the draw. (See VII.8.3 and VII.8.4)

25.5 The time limits for different age groups, including ten (10) seconds of deck movements, shall be:

25.5.1 12 & Under / Youth

| | |
|------------------|------|
| Solo | 2:00 |
| Duet/Mixed Duet | 2:30 |
| Team | 3:00 |
| Free Combination | 3:00 |

25.5.2 Junior Free Routines

| | |
|-----------------|------|
| Solo | 2:15 |
| Duet/Mixed Duet | 2:45 |
| Team | 3:30 |
| Acrobatic | 3:00 |

25.5.2 Junior Technical Routines

| | |
|--------|------|
| Solo | 2:00 |
| Duets: | 2:20 |
| Team: | 2:50 |

There shall be an allowance of five (5) seconds less or plus the allotted time limit.

25.6 In the Youth Team event, the two (2) required movements in any of the six (6) Free Hybrids from Appendix III can be either part of a hybrid or constitute a hybrid itself. In both case, these movements have to be clearly identified in the Coach Card. Entries will be accepted only under this premise.

26. SWIMWEAR AND WEARABLES

Swimwear for men in Artistic Swimming shall not extend above the navel nor below the upper thigh.

27. ARTISTIC SWIMMING FACILITIES AND EQUIPMENT

27.1 Artistic Swimming Facilities

27.1.1 Figure Section

The areas for figure competition in VII.27.1.1 can occupy the same area of the pool as that used for routine competition in VII.27.1.2 approved by TASC.

27.1.2 Routine Section

For the routine section of the competition a minimum area of 15 metres by 25 metres is required, within an area of which 12 metres by 12 metres must have a minimum depth of 3.0 metres. The depth of the remaining area shall be 2.0 metres minimum.

27.1.3 Depth

The pool depth shall be as detailed in VII.27.1.2.

Where the water depth is more than 2.0 metres, the depth at the pool wall may be 2.0 metres and then sloped down to reach the general depth at 1.2 metres maximum from the pool wall.

27.1.4 Lane markings

If there are no lane markings as described in III.16.2.15, the floor of the pool must be marked with contrasting lines in one direction, following the length of the pool as detailed in: *Artistic Swimming Diagram Annex 1*.

27.1.5 Water Conditions

27.1.5.1 The water must be of sufficient clarity for the bottom of the pool to be visible.

27.1.5.2 The water temperature shall not be less than 27° Centigrade.

27.1.6 Lighting

The minimum light intensity at the level of 1 metre above the water surface shall not be less than 600 lux.

Sources of natural and artificial illumination shall be provided with controls to prevent glare for judges platforms and the starting platform.

27.1.7 Starting Platform

Starting platform is recommended 0.7 metres in height but not less than 0.5 metres.

The surface of the platform should be covered in a slip-resistant material suggest a quick drying water proof carpet.

27.2 Artistic Swimming Facilities for Olympic Games and World Aquatics Championships

27.2.1 General requirement

The Field of Play for Artistic Swimming in Olympic Games and World Aquatics Championships as detailed in: *Artistic Swimming Diagrams, Annex AS1 and AS 2*

27.2.2 Routine Section

For the routine section of competition at Olympic Games and World Aquatics Championships a minimum area of 30.0 metres by 20.0 metres is required.

27.2.3 Depth

The depth of the water shall be consistently not less than 3.00 metres.

27.2.4 Lane markings

If there are no lane markings as described in III.16.2.15, the floor of the pool must be marked with contrasting lines in one direction, following the length of the pool as detailed in: *Artistic Swimming Diagram, Annex 1*.

27.2.5 Water Conditions

27.2.5.1 The water must be of sufficient clarity for the bottom of the pool to be visible.

27.2.5.2 The water temperature shall not be less than 27° Centigrade.

27.2.6 Lighting

The light intensity at the level of 1 metre above the water surface shall not be less than 1500lux.

Sources of natural and artificial illumination shall be provided with controls to prevent glare for judges platforms and the starting platform.

27.2.7 Starting Platform

Starting platform shall be 0.7 metres in height with a tolerance of ± 1 cm.

The surface of the platform should be covered in a slip-resistant material suggest a quick drying water proof carpet. *See Artistic Swimming Diagrams,*

Annexes 1 and 2.

27.2.8 Judges Platform

The Judges Platform must have tables and chairs and be of a minimum height of 0.6 metres. *The platforms should be no more than 2 metres from the edge of the pool.*

22 See Artistic Swimming Diagrams, Annex 1 and AS2.

27.2.9 Practice warm up pool

Practice warm up pool shall have a minimum area of 25 metres by 25 metres or 30 metres by 20 metres with a depth of 3 metres.

A sound reproduction system meeting the requirements set in VII.27.3 shall be available.

27.2.10 Dry Land Training

A Dry land training stretch area must be provided for the athletes with mats.

27.3 Automatic Officiating Equipment for Artistic Swimming

The minimum installation consists of:

27.3.1 same number of score recorder units as judges (figure: 5 up to 28; routine 5 up to 15)

27.3.2 the results may only be transferred after confirmation by the referee or appointed official.

27.3.3 result unit (computer) with result recording and backup system. Only World Aquatics approved programmes and systems are allowed.

27.3.4 print out system for all recorded information, start lists and result lists;

27.3.5 A judge's evaluation system based on the recorded results (FR 5.3.3). The World Aquatics TASC approved evaluation programme is required.

27.3.6 scoreboard control unit with a scoreboard; of a minimum of 10 lines containing 32 digits (or scoreboard as described in Artistic Swimming Facilities Rules. The scoreboard must be able to display all recorded information and the running time;

27.3.7 for each judge flash cards in case of failure of the electronic system.

27.3.8 Timing System

An automated timing system with 3 independent timers timing walk-on time, deck movement time and overall time. The timers should be placed close to the result secretariat.

27.3.9 Under water review system

Underwater camera is required with mounting and harness to the wall or bottom depending on the type. The system must have video server or a computer control centre with data storage with the capacity for immediate slow motion replay. A monitor for the TASC to perform immediate reviews must be available.

27.3.10 Routine and Figure review system

2 to 4 cameras in defined positions with mounting and harness video server or computer control centre and data storage with the capacity for slow motion instant replay must be available.

27.4 Sound Equipment and Presentation Standards for Artistic Swimming

The sound equipment should include, at minimum:

27.4.1 Amplifier-mixer system

Mixer should have at least 16 inputs and 6 outputs (LR (Left-Right channels) PA, LR Speaker system on the field of competition, 2 outputs Spare/or for Broadcasting). Amplifiers should be suitable for used speakers.

27.4.2 A sound reproduction system

27.4.2.1 High quality microphones and microphone stations for announcements and ceremonies.

27.4.2.2 High quality air speakers (AS) of size, number and placement to obtain uniform clear sound to the field of competition area. And should be able to produce 105 dB SPL (sound pressure level) A without distortion. The maximum SPL shall not exceed 125 dB SPL A. Speakers frequency response should be at least 40Hz-16kHz.

27.4.2.3 High quality air speakers (AS) of size, number and

placement to obtain uniform clear sound to the start podium of competition area. And should be able to produce 105 dB SPL A without distortion. The maximum SPL shall not exceed 125 dB SPL A. Speakers frequency response should be at least 40Hz-16kHz.

27.4.2.4 All air speaker (AS) in the field of competition should be «passive» (without built-in amplifier) to avoid risk of electrical shock.

27.4.2.5 UWS (Under Water Speaker) for clear and uniform underwater sound above. UWS should be able to produce 98dB A without distortion. The maximum SPL shall not exceed 110 dB SPL A. UWS frequency response should be at least 200Hz-10kHz. Isolation and impedance matching transformer systems for the UW speakers.

27.4.2.6 DSP (Digital Sound Processor) to make amplitude frequency characteristic and delay corrections in between AS and UWS. DSP should have at least 2 inputs and independent 6 outputs (or 3 Stereo independent outputs). Each output should have HPF (High Pass Filter), LPF (Low Pass Filter), GEQ (Graphic equalizer) and/or Parametric equalizer, compressor/limiter, Delay (minimum 5 seconds).

27.4.3 PA (Public Address) System (Sound reproducing system for spectators)

27.4.3.1 The sound system shall be capable to cover spectators seats at least with 110 dB A with deviations in overall direct sound levels across the spectator seating area not exceeding +/- 3 dB A. The maximum SPL shall not exceed 125 dB SPL A.

27.4.3.2 STI PA (speech transmission index for PA systems) should be in 0,5-1.0 STI.

27.4.3.3 The PA system shall provide enough headroom to compensate for the atmospheric loss of high frequencies.

27.4.3.4 The PA system should have a minimal impact to the field of competition to avoid sound delay problems.

27.4.4 Sound volume (decibel) meter for monitoring music

sound levels both above and under water.

27.4.5 Patch cords for interconnecting equipment properly, speaker extension lines adequate for placing speakers for optimal sound distribution.

27.4.6 Fusing systems as needed to protect speakers and other equipment.

27.4.7 Grounding lines to ensure safe grounding of all equipment.

27.4.8 Safety materials to minimize potential of injury to person or equipment from stepping on or tripping over electrical or speaker lines.

27.4.9 A stopwatch.

27.4.10 Tools and meters as needed for initial special hookups and emergency repairs.

27.4.11 Systems for communication between officials and sound desk.

27.4.12 A system for monitoring and recording underwater sound continuously.

27.5 Annexes

Annex 1 - Diagram – Artistic Swimming Field of Play for Olympic Games and World Aquatics Championships

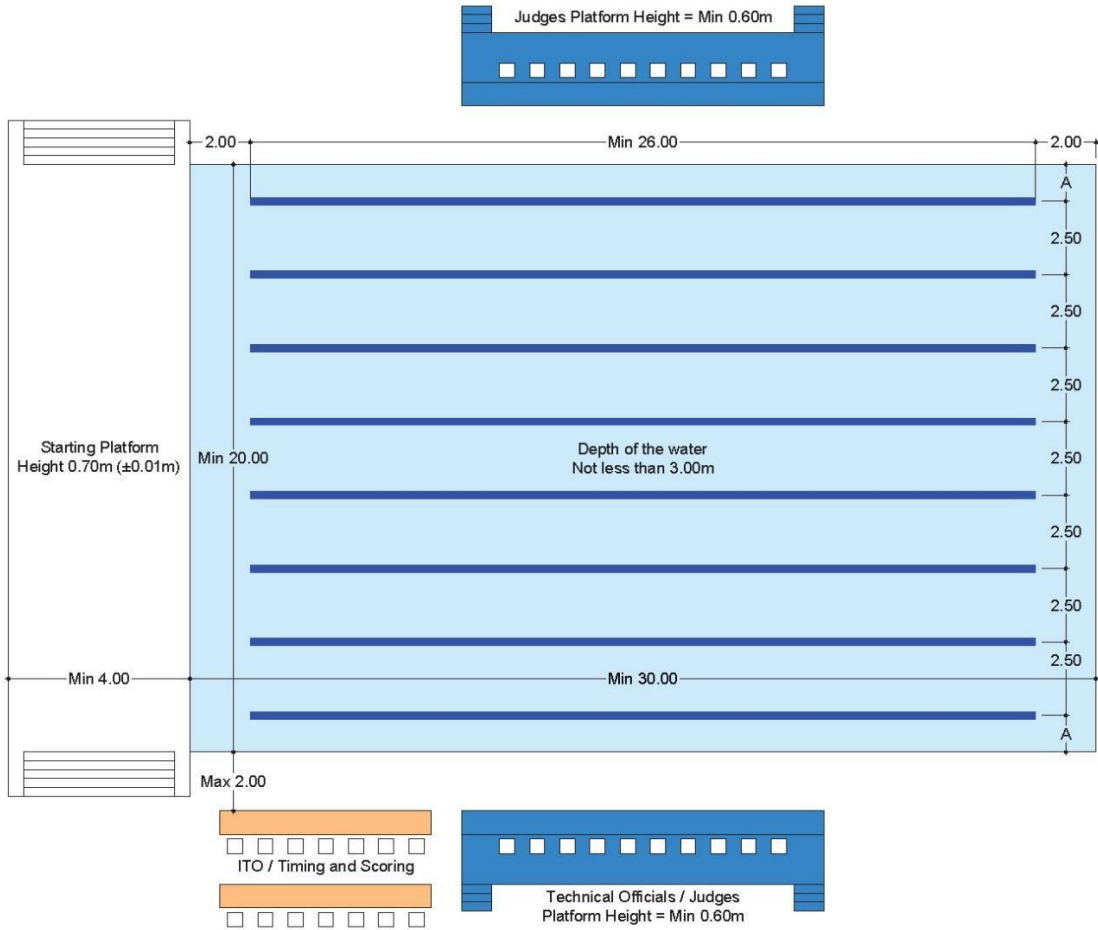

Annex 2 - Diagram – Artistic Swimming Field of Play for Olympic Games and World Aquatics Championships



28. Medical and Safety specific requirement for Artistic Swimming

The Medical Requirements are described in the section I.9.2. However, each sport has unique components.

28.1 Location of the FoP First Aid Treatment Area

FoP First Aid Treatment Area should be positioned near the starting platform and athletes exit.

28.2 Water Rescue and Lifeguards

During Competition, three (3) lifeguards are required. One (1) lifeguard shall be positioned next to the coach of the competing swimmer(s) to react immediately in an emergency. Two (2) lifeguards should be positioned on different sides of the pool to cover the whole competition area.

At the warm-up pool, a minimum of at least two (2) lifeguards are required.

29. APPENDICES

APPENDIX 1 – World Aquatics Basic Position, Basic Movement and Figures

APPENDIX 2 – Technical Routines

APPENDIX 3 – Set Number of Elements for Routines

APPENDIX 4 – Required Elements for Acrobatic Routines

APPENDIX 5 – Required Elements for the Free Combination

APPENDIX 6 – Acrobatics Catalogue

APPENDIX 7 – Coach Card Template

29.1 Appendix 1 World Aquatics Basic Position, Basic Movement and Figures



29.1.1 Basic Body Position (BP)

In all basic body positions:

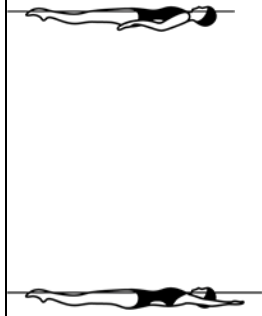
- a) arm positions are optional,
- b) toes must be pointed, ankles must be extended,
- c) the legs, trunk and neck are fully extended unless otherwise specified and
- d) diagrams are a guide only. If there is a discrepancy between a diagram and a written description, the English written Body Position description prevails.

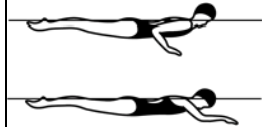
| | | |
|----------|---|---|
| 1 | BACK LAYOUT POSITION | |
| | Body extended with face, chest, thighs and feet at the surface of the water. Head (ears specifically), hips and ankles in horizontal alignment. |  |

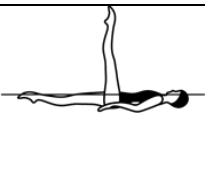
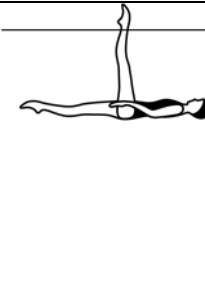
| | | |
|----------|--|---|
| 2 | FRONT LAYOUT POSITION | |
| | Body extended with head, upper back, buttocks and heels at the surface of the water. Unless otherwise specified, face may be in or out of the water. |  |

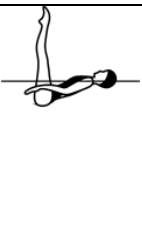

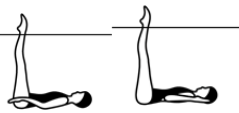
| | |
|---|---|
| 3 BALLET LEG POSITION | |
| a) Surface Body in Back Layout Position . One leg extended perpendicular to the surface of the water |  |
| b) Submerged Head, trunk and horizontal leg parallel to the surface of the water. One leg perpendicular to the surface with the water level between the knee and the ankle. |  |
| 4 FLAMINGO POSITION | |
| a) Surface One leg extended perpendicular to the surface of the water. The other leg bent with the mid-calf opposite the vertical leg. Foot, shin and knee at and parallel to the surface of the water. Face at the surface of the water. |  |
| b) Submerged Trunk, head, shin and foot of the bent leg parallel to the surface of the water. 90° angle between the trunk and extended leg. Water level between knee and ankle of the extended leg. |  |
| 5 BALLET LEG DOUBLE POSITION | |
| a) Surface Legs together and extended perpendicular to the surface of the water. Head in line with the trunk. Face at the surface of the water. |  |

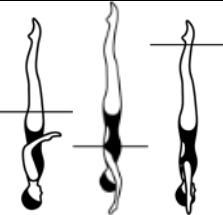

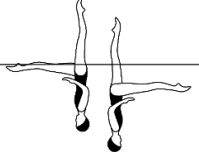

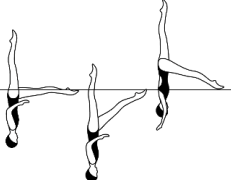

| | |
|--|---|
| <p>b) Submerged</p> <p>Trunk and head parallel to the surface of the water. 90° angle between the trunk and the extended legs. Water level between knees and ankles of the extended legs.</p> |  |
|--|---|



| | |
|---|---|
| <p>6 VERTICAL POSITION</p> <p>Body extended perpendicular to the surface of the water; legs together, head downward. Head (ears specifically), hips and ankles in line</p> |  |
|---|---|



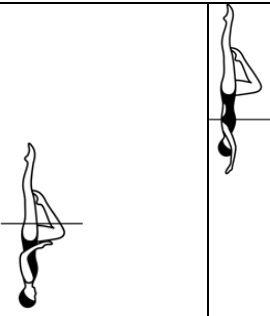
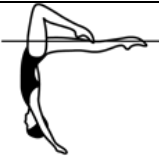

| | |
|---|---|
| <p>7 CRANE POSITION – this position is currently not performed in any World Aquatics figure.</p> | |
| <p>Body extended in Vertical Position with one leg extended forward at a 90° angle to the body</p> |  |

| | |
|---|---|
| <p>8 FISHTAIL POSITION</p> <p>Body extended in Vertical Position with one leg extended forward. The foot of the forward leg is at the surface of the water regardless of the height of the hips.</p> |  |
|---|---|

| | | |
|---|---|---|
| <p>9 TUCK POSITION</p> <p>Body as compact as possible, with the back rounded and the legs together. Heels close to buttocks. Head close to knees</p> |  |  |
|---|---|---|

| | | |
|--|---|---|
| 10 FRONT PIKE POSITION | | |
| <p>Body bent at hips to form a 90° angle. Legs extended and together. Trunk extended with the back straight and head in line.</p> |  |  |
| 11 BACK PIKE POSITION | | |
| <p>Body bent at hips to form an acute angle of 45° or less. Legs extended and together. Trunk extended with the back straight and head in line.</p> |  |  |
| 13 SURFACE ARCH POSITION | | |
| <p>Lower back arched with hips, shoulders and head on a vertical line. Legs together and at the surface of the water.</p> |  | |
| 14 BENT KNEE POSITIONS | | |
| <p>Body in Front Layout, Back Layout, Vertical, or Arched Positions. One leg bent, with the toe of the bent leg in contact with the inside of the extended leg at the knee or higher.</p> | | |
| <p>a) Bent Knee Front Layout Position</p> <p>Body extended in Front Layout Position with the thigh of the bent leg perpendicular to the surface of the water. Unless otherwise specified face may be in or out of the water.</p> |  | |

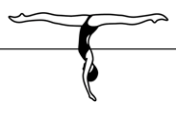
| | |
|--|---|
| <p>b) Bent Knee Back Layout Position</p> <p>Body extended in Back Layout Position. The thigh of the bent leg is perpendicular to the surface of the water.</p> |  |
| <p>c) Bent Knee Vertical Position</p> <p>Body extended in Vertical Position with the thigh of the bent leg parallel to the surface of the water.</p> |  |
| <p>d) Bent Knee Surface Arch Position</p> <p>Lower back arched with hips, shoulders and head on a vertical line. The thigh of the bent leg is perpendicular to the surface of the water</p> |  |
| <p>15 TUB POSITION</p> | |
| <p>Legs bent and together, feet and shins at and parallel to the surface of the water with thighs perpendicular. Head in line with trunk. Face at the surface of the water.</p> |  |

| | |
|---|---|
| 16 SPLIT POSITION | |
| <p>Legs evenly split forward and back. The legs are parallel to the surface of the water. Lower back arched, with hips, shoulders and head on a vertical line. 180° angle between the extended legs (flat split), with inside of each leg aligned on opposite sides of a horizontal line, regardless of the height of the hips.</p> |  |
| <p>a) Surface Split Position</p> <p>Legs are dry at the surface of the water.</p> |  |
| <p>b) Airborne Split Position</p> <p>Legs are above the surface of the water</p> |  |
| 17 KNIGHT POSITION | |
| <p>Lower back arched, with hips, shoulders and head on a vertical line. One leg vertical. Other leg extended backward with the leg at the surface of the water and as close to horizontal as possible.</p> |  |
| 18 KNIGHT VARIANT POSITION | |
| <p>Lower back arched, with hips, shoulders and head on a vertical line. One leg vertical. The other leg is behind the body with the knee bent at an angle of 90° or less. The thigh and shin of the bent leg are parallel to the surface of the water.</p> |  |

| | |
|---|---|
| 19 SIDE FISHTAIL POSITION | |
| Body extended in Vertical Position with one leg extended sideways with the foot at the surface of the water regardless of the height of the hips |  |

29.1.2 Basic Movements (BM)

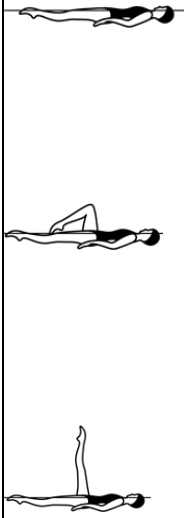
| | |
|--|--|
| 1 TO ASSUME A BALLETT LEG / A BALLETT LEG IS ASSUMED | |
| Begin in a Back Layout Position . One leg remains at the surface of the water throughout. The foot of the other leg is drawn along the inside of the extended leg to assume a Bent Knee Back Layout Position . The bent leg is straightened without movement of the thigh to assume a Ballet Leg Position . |  |

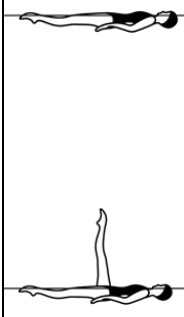
| | |
|---|---|
| 1B TO ASSUME A STRAIGHT BALLETT LEG / A STRAIGHT BALLETT LEG IS ASSUMED | |
| From a Back Layout Position one leg is raised straight to a Ballet Leg Position . |  |

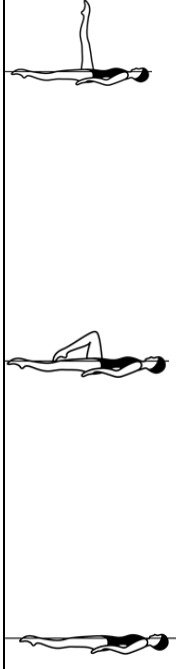
| | |
|--|--|
| <p>2 TO LOWER A BALLETT LEG /THE BALLETT LEG IS LOWERED</p> | |
| <p>From a Ballet Leg Position the ballet leg is bent without movement of the thigh to a Bent Knee Back Layout Position. The toe moves along the inside of the extended leg until a Back Layout Position is assumed.</p> |  |

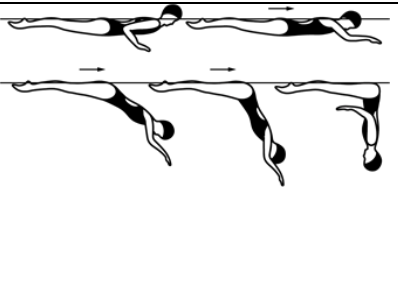
| | |
|---|---|
| <p>3 TO ASSUME A FRONT PIKE POSITION / A FRONT PIKE POSITION IS ASSUMED</p> | |
| <p>From a Front Layout Position with the face in the water the trunk moves downward to assume a Front Pike Position. The buttocks, legs and feet travel along the surface of the water until the hips occupy the position of the head at the beginning of this action</p> |  |

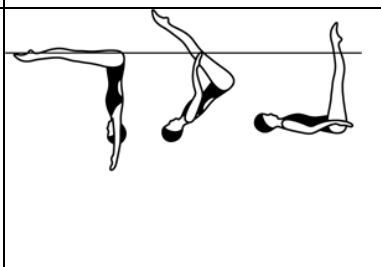
| | |
|---|---|
| <p>4 TO ASSUME A SUBMERGED BALLET LEG DOUBLE POSITION FROM A FRONT PIKE POSITION/A SUBMERGED BALLET LEG DOUBLE POSITION IS ASSUMED</p> | |
| <p>While maintaining a Front Pike Position the body somersaults forward around a lateral axis as the buttocks, legs and feet move downward. The hips replace the head to assume a Submerged Ballet Leg Double Position.</p> |  |

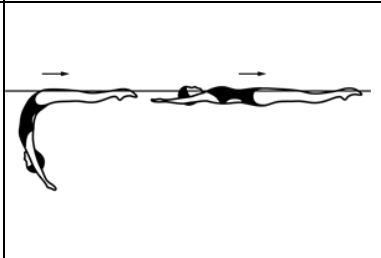
| | |
|--|---|
| <p>5 ARCH TO BACK LAYOUT POSITION</p> | |
| <p>From a Surface Arch Position the hips, chest and face surface sequentially at the same point with foot first movement to a Back Layout Position until the head occupies the position of the hips at the beginning of this action.</p> |  |

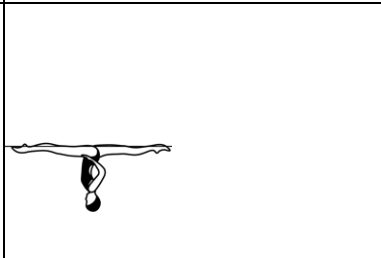
| | |
|---|---|
| <p>6 WALKOUTS</p> | |
| <p>These movements start in a Split Position unless otherwise specified in the figure description. The hips remain stationary as one leg is lifted in an arc over the surface of the water to meet the opposite leg.</p> |  |

| |
|--|
| <p>a) Walkout Front</p> <p>The front leg is lifted in a 180° arc over the surface of the water to meet the opposite leg in a Surface Arch Position and with continuous movement an <i>Arch to Back Layout Finish Action</i> is executed.</p> |
|--|

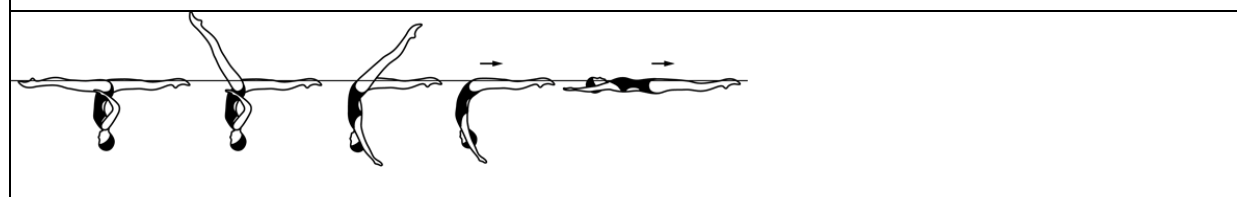

b) Walkout Back

The back leg is lifted in a 180° arc over the surface of the water to meet the opposite leg in a **Front Pike Position** and with continuous movement the body straightens to a **Front Layout Position**. The head surfaces at the position occupied by the hips at the beginning of this action.

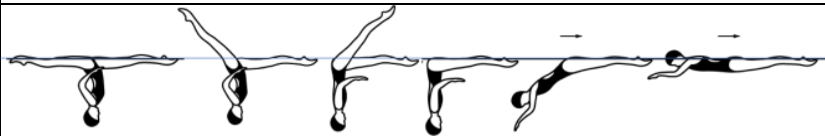

7 CATALINA ROTATION

From a **Ballet Leg Position** a rotation of the body is initiated. The head, shoulders and trunk begin the rotation at the surface of the water while descending without lateral movement to a **Fishtail Position**. The vertical leg remains perpendicular to the surface of the water while the foot of the horizontal leg remains at the surface of the water throughout the rotation. Unless otherwise specified, *Catalina Rotation* starts from a **Ballet Leg Position**.

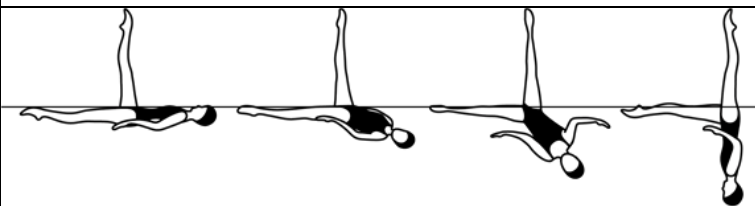

8 CATALINA REVERSE ROTATION

From a **Fishtail Position** the hips rotate as the trunk rises without lateral movement to assume a **Ballet Leg Position**. The vertical leg remains perpendicular to the surface of the water while the foot of the horizontal leg remains at the surface of the water throughout the rotation.

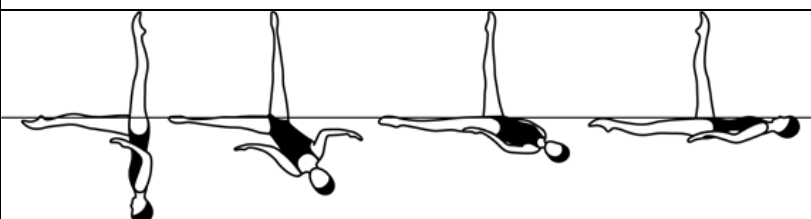

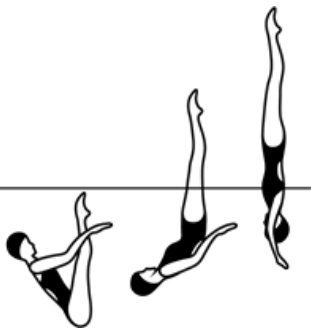
| | | |
|---|----------------------------|---|
| 9 THRUST | | |
| <p>From a Submerged Back Pike Position with the legs perpendicular to the surface of the water a vertical upward movement of the legs and hips is rapidly executed as the body unrolls to assume a Vertical Position. Maximum height desirable.</p> | |  |
| <p>THRUST ALLOWANCE</p> <p>Deviation allowances for the <i>Thrust</i> action are unique and allow for the legs to be up to an additional 15 degrees off the vertical line.</p> | | |
| Deductions are as follows: | | |
| | Angle Deviation | Deduction Amount |
| Small Deviation | 0 – 30 degrees | 0.2 |
| Medium Deviation | 31 – 44 degrees | 0.5 |
| Large Deviation | 45 degrees or more | 1.0 |

| | |
|---|---|
| <p>10 VERTICAL DESCENT</p> | |
| <p>Maintaining a Vertical Position the body descends along its longitudinal axis until the toes are submerged.</p> |  |

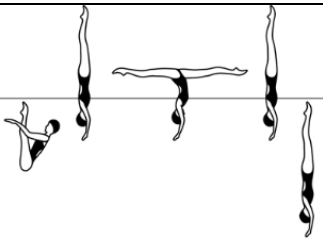
| |
|---|
| <p>11 ROCKET SPLIT</p> |
| <p>A <i>Thrust</i> is executed to a Vertical Position. Maintaining maximum height the legs are split simultaneously and rapidly to assume an Airborne Split Position and rejoin to a Vertical Position, followed by a <i>Vertical Descent</i>. The <i>Vertical Descent</i> is executed at the same tempo as the <i>Thrust</i>.</p> |
|  |

12 TWISTS

A *Twist* is a rotation at a sustained height. The body remains on its longitudinal axis throughout the rotation. Unless otherwise specified when performed in a **Vertical Position** a *Twist* is completed with a *Vertical Descent*.

a) Half Twist:

a *Twist* of 180°

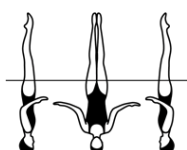

b) Full Twist:

a *Twist* of 360°

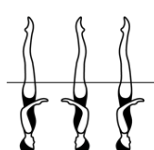

c) A Twist:



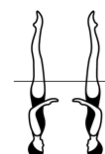

a rapid *Twist* of 180°

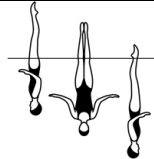
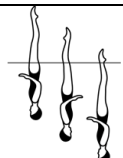
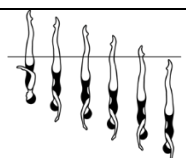
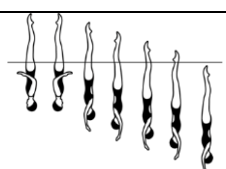

Twist Allowance

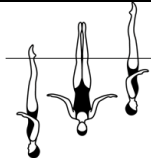
The acceptable allowance for *Twist* rotations (*Half Twist*, *Full Twist* and *Twirl*) is up to ¼ less than/more than the required rotation.

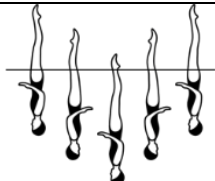
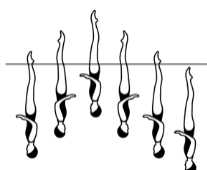
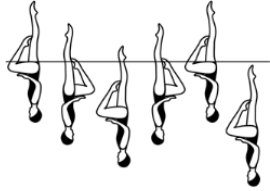
| 13 SPINS | |
|---|---|
| <p>A <i>Spin</i> is a rotation in a Vertical Position. The body remains on its longitudinal axis throughout the rotation. Unless otherwise specified <i>Spins</i> are executed in uniform motion and are completed with a <i>Vertical Descent</i> executed at the same tempo as the <i>Spin</i>.</p> <p>A <i>descending Spin</i> must start at the height of the vertical and be completed as the ankle(s) reach(es) the surface of the water. Unless otherwise specified a <i>descending Spin</i> is completed with a <i>Vertical Descent</i> which is executed at the same tempo as the <i>Spin</i>.</p> | |
| <p>d) 180° Spin/Spinning 180°: a <i>descending Spin</i> with a rotation of 180°</p> |  |
| <p>e) 360° Spin/Spinning 360°: a <i>descending Spin</i> with a rotation of 360°.</p> |  |
| <p>f) Continuous Spin: a <i>descending Spin</i> with a rapid rotation of: 720° (2), 1080° (3), or 1440° (4) which is completed as the ankles reach the surface of the water and continues through submergence.</p> <p>Continuous Spin 720° shown →</p> |  |
| <p>g) Twist Spin: a <i>Half Twist</i> is executed and without a pause is followed by a <i>Continuous Spin</i> of 720°</p> <p>(2) performed in the same direction as the <i>Half Twist</i>.</p> |  |

| 13 SPINS (cont.) | |
|---|---|
| <p>An <i>ascending Spin</i> begins with the water level at the ankles unless otherwise specified. A vertical upward <i>Spin</i> is executed until a water level is established between the knees and hips. An <i>ascending Spin</i> is finished with a <i>Vertical Descent</i>.</p> | |
| <p>h) Spin Up 180°: an <i>ascending Spin</i> with a rotation of 180°</p> |  |
| <p>i) Spin Up 360°: an <i>ascending Spin</i> with a rotation of 360°.</p> |  |
| <p>j) Combined Spin: a <i>descending Spin</i> of at least 360° followed without a pause by an equal <i>ascending Spin</i> in the same direction. The <i>ascending Spin</i> reaches the same height where the <i>descending Spin</i> started.</p> |  |
| <p>k) Reverse Combined Spin: an <i>ascending Spin</i> of at least 360° followed without a pause by an equal <i>descending Spin</i> in the same direction.</p> |  |
| <p>l) Bent Knee Combined Spin: a <i>descending Spin</i> in a Bent Knee Vertical Position of at least 360° followed without a pause by an equal <i>ascending Spin</i> in the same direction in a Bent Knee Vertical Position. The <i>ascending Spin</i> reaches the same height where the <i>descending Spin</i> started.</p> |  |
| <p>m) Reverse Bent Knee Combined Spin: an <i>ascending Spin</i> in a Bent Knee Vertical Position of at least 360° followed without a pause by an equal <i>descending Spin</i> in the same direction in a Bent Knee Vertical Position.</p> |  |

Spin Allowance

The acceptable allowance for a *Continuous Spin* is up to 180° less than/more than the required rotation.

The acceptable allowance for other *Spins* (*180° Spin, 360° Spin, 720° Spin, Twist Spin, Spin Up 180°, Spin Up 360°*) is up to ¼ less than/more than the required rotation

14. TO ASSUME A SURFACE ARCH POSITION / A SURFACE ARCH POSITION IS ASSUMED

From a **Back Layout Position** with the head leading, the head, hips and feet move along the surface of the water. With continuous movement the head leaves the surface of the water as the back is arched more to assume a **Surface Arch Position** with the hips occupying the position of the head at the beginning of this action

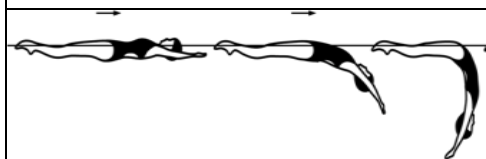
15 TO ASSUME A BENT KNEE SURFACE ARCH POSITION / A BENT KNEE SURFACE ARCH POSITION IS ASSUMED

From a **Back Layout Position** with the head leading, the head, hips and feet move along the surface of the water. With continuous movement the head leaves the surface of the water as the back is arched more to assume a **Bent Knee Surface Arch Position** with the hips occupying the position of the head at the beginning of this action

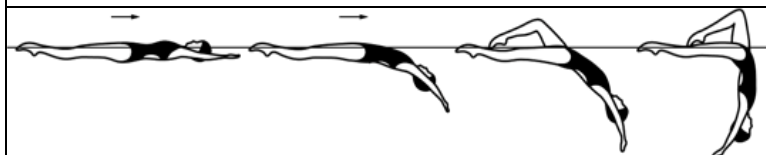

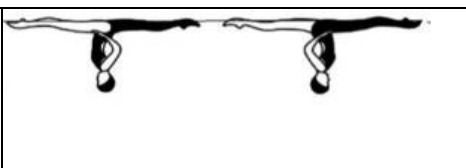
16 ARIANA ROTATION

| | |
|---|---|
| <p>From a Split Position maintaining the relative position of the legs to the surface of the water the hips rotate 180°.</p> |  |
|---|---|

| |
|-------------------------------|
| 17 HELICOPTER ROTATION |
|-------------------------------|

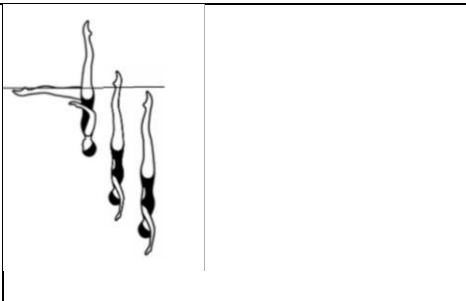
| |
|---|
| <p>From a Fishtail Position the horizontal leg is lifted while closing into the vertical leg to assume a Vertical Position during a descending rotation and is completed as the ankles reach the surface of the water</p> |
|---|

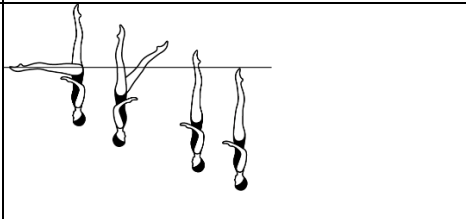
| | |
|---|--|
| <p>a) <i>Spinning 180°</i>: A descending Spin with a rotation of 180° completed with a <i>Vertical Descent</i>.</p> |  |
|---|--|

| | |
|---|---|
| <p>b) <i>Spinning 360°</i>: A descending Spin with a rotation of 360° completed with a <i>Vertical Descent</i>.</p> |  |
|---|---|

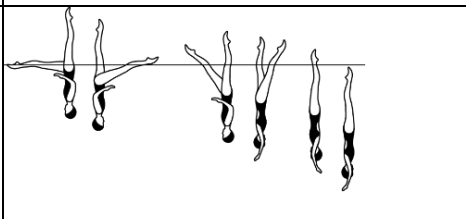
| | |
|--|---|
| <p>c) <i>Continuous Spin 720°</i>: a descending Spin with a rapid rotation of: 720° (2), completed as the ankles reach the surface of the water and continues through submergence.</p> |  |
|--|---|

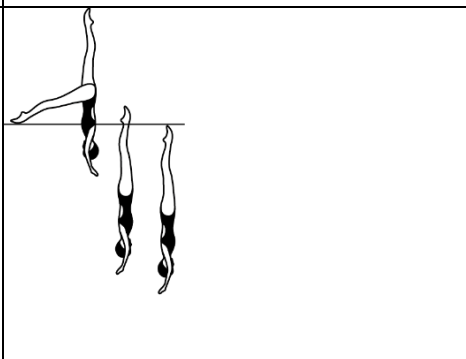
| | |
|--|---|
| <p>d) <i>Rapid Airborne Spinning 180°</i>: from an airborne Fishtail Position the horizontal leg is rapidly lifted while closing into the vertical leg to Vertical Position during a rapid <i>descending Spin</i> with a rotation of 180° and is completed as the ankles reach the surface of the water followed by a rapid <i>Vertical Descent</i>.</p> |  |
|--|---|

| | |
|----------------------------|--|
| 18 FOUETTÉ ROTATION | |
|----------------------------|--|

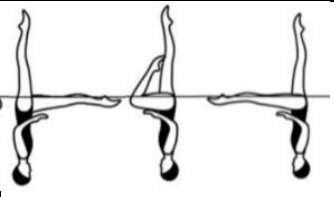
| | |
|--|---|
| From a Fishtail Position with the horizontal leg leading toward the vertical leg a rapid 180° rotation is executed as the front leg bends to assume a Bent Knee Vertical Position . The bent leg rapidly extends to a Fishtail Position. |  |
|--|---|

29.1.3 12 and Under Figures





| Group & Figure # | Figure Name | DD |
|-------------------------|-----------------------|-----|
| Compulsory | | |
| 106 | Straight Ballet Leg | 1.6 |
| 301 | Barracuda | 1.8 |
| Optional Groups: | | |
| Group 1 | | |
| 359 | Front Ariana | 2.2 |
| 348 | Tower | 1.9 |
| Group 2 | | |
| 363 | Water Drop | 1.8 |
| 401 | Swordfish | 2.1 |
| Group 3 | | |
| 311 | Kip | 1.6 |
| 227d | Swanita Spinning 180° | 1.9 |

29.1.3.1 Compulsory:

1 - 106 Straight Ballet leg DD 1.6

A straight Ballet Leg is Assumed. The Ballet Leg is lowered.





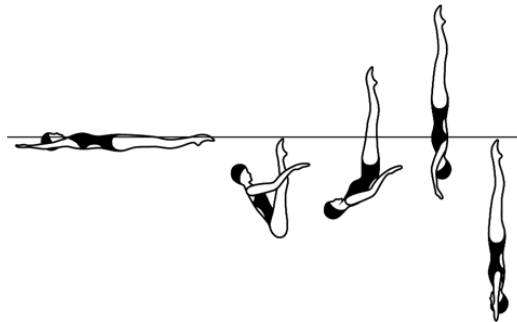

| | | | | |
|---|---|---|--|--------------|
|  |  |  |  | Total |
| NVT= | 18.5 | 11.0 | 10.5 | 40 |
| PV = | 4.63 | 2.75 | 2.63 | 10 |

2 - 301 Barracuda DD 1.8

From a **Back Layout Position** the legs are raised to vertical as the body is submerged to a **Back Pike Position** with the toes just under the surface of the water. A *Thrust* is executed to a **Vertical Position**. A *Vertical Descent* is executed at the same tempo as the *Thrust*.



| | | | | |
|---|---|---|---|--------------|
|  |  |  |  | Total |
| NVT= | 7.0 | 31.0 | 13.0 | 51 |
| PV = | 1.37 | 6.08 | 2.55 | 10 |







29.1.3.2 Optional Groups

29.1.3.2.1 Group 1

3 - 359 Front Ariana DD 2.2

From a Front Layout Position a *Front Pike Position* is assumed. One leg is lifted in a 180° arc over the surface of the water to a Split Position. Maintaining the relative position of the legs to the surface of the water, an *Ariana Rotation* is performed. A *Walkout Front* is executed.





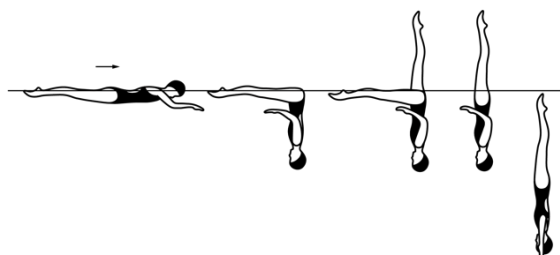

| | | | | | | |
|--|--|--|--|--|---|--------------|
|  |  |  |  |  |  | Total |
| NVT= | 6.0 | 20.0 | 17.0 | 23.0 | 7.0 | 73 |
| PV = | 0.82 | 2.74 | 2.33 | 3.15 | 0.96 | 10 |

4 - 348 Tower DD 1.9

From a **Front Layout Position** a Front Pike Position is assumed. One leg is lifted to a **Fishtail Position**. The horizontal leg is lifted to a **Vertical Position**. A Vertical Descent is executed.







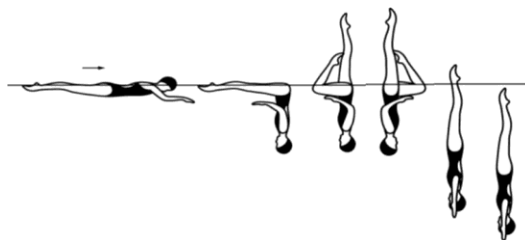

| | | | | | | |
|---|---|---|---|--|--------------|----|
|  |  |  |  |  | Total | |
| NVT= | 6.0 | 14.5 | 20.5 | 14.0 | | 55 |
| PV = | 1.09 | 2.64 | 3.73 | 2.55 | | 10 |

29.1.3.2.2 Group 2

3 - 363 Water Drop DD 1.8

From a **Front Layout Position** a *Front Pike Position* is assumed. The legs are lifted simultaneously to a **Bent Knee Vertical Position**. A *Half Twist* is executed. A *180° Spin* is executed in the same direction as the bent leg is extended to a **Vertical Position** and completed as the ankles reach the surface of the water. A *Vertical Descent* is executed.





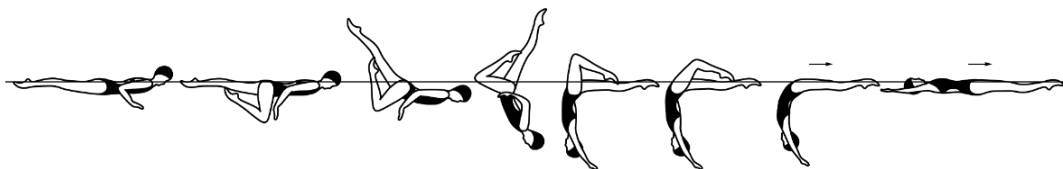

| | | | | | | |
|---|---|---|---|---|---|--------------|
|  |  |  |  |  |  | Total |
| NVT= | 6.0 | 15.0 | 15.0 | 13.0 | 0 | 49 |
| PV = | 1.22 | 3.06 | 3.06 | 2.65 | 0 | 10 |

- 401 Swordfish DD 2.1

From a **Front Layout Position** a **Bent Knee Front Layout Position** is assumed. The back arches more as the extended leg is lifted in a 180° arc over the surface of the water to assume a **Bent Knee Surface Arch Position**. The bent leg is straightened to assume a **Surface Arch Position**. With continuous motion an *Arch to Back Layout Finish Action* is executed.



| | | | | | |
|---|---|---|---|--|--------------|
|  |  |  |  |  | Total |
| NVT= | 4.0 | 47.0 | 11.5 | 7.0 | 69.5 |

| | | | | | |
|------|------|------|------|------|----|
| PV = | 0.58 | 6.76 | 1.65 | 1.01 | 10 |
|------|------|------|------|------|----|

29.1.3.2.3 Group 3

3- 311 Kip DD1.6

From a **Back Layout Position** the knees, shins and toes are drawn along the surface of the water to assume a **Tuck Position**. With continuous motion the tuck becomes more compact and a partial Somersault Back Tuck is executed until the shins are perpendicular to the surface of the water. The trunk unrolls as the legs are straightened to assume a **Vertical Position** midway between the former vertical line through the hips and the former vertical line through the head and shins. A *Vertical Descent* is executed.

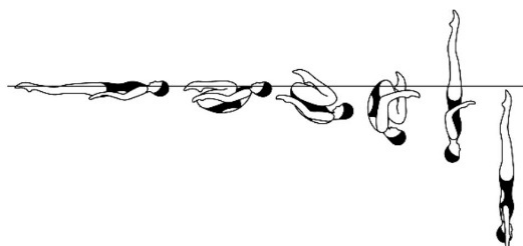

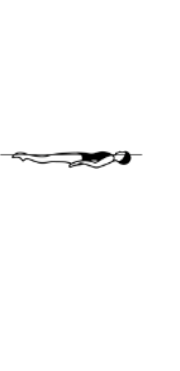
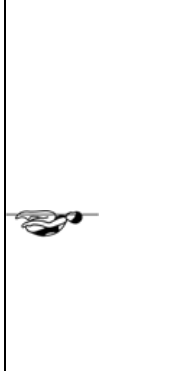
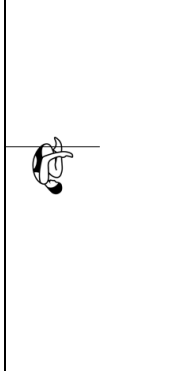
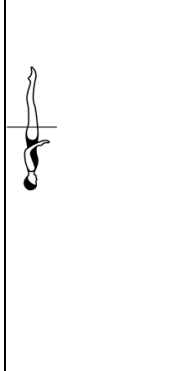
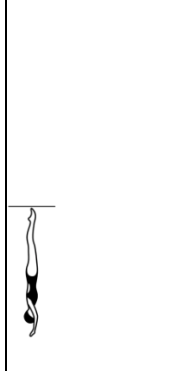



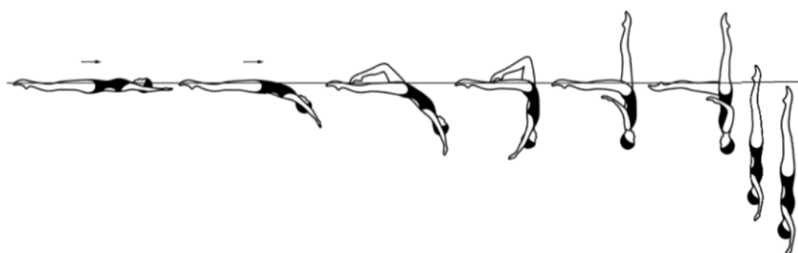

| | | | | | |
|---|---|---|---|--|--------------|
|  |  |  |  |  | Total |
| NVT= | 3.0 | 2.0 | 23.0 | 14.0 | 42 |
| PV = | 0.71 | 0.48 | 5.48 | 3.33 | 10 |

4- 227d Swanita Spinning 180° DD1.9

From a **Back Layout Position** a *Bent Knee Surface Arch Position* is assumed.

The bent leg straightens to assume a **Knight Position**. The body rotates 180° to assume a **Fishtail Position**. Continuing in the same direction a descending *Spinning 180°* rotation is executed as the horizontal leg is lifted to a **Vertical Position** and is completed as the ankles reach the surface of the water. A *Vertical Descent* is executed.



| | | | | | | Total | |
|------|---|---|---|---|---|---|----|
| |  |  |  |  |  |  | |
| NVT= | | 17.5 | 14.0 | 14.0 | 12.5 | 0 | 58 |
| PV = | | 3.02 | 2.41 | 2.41 | 2.16 | 0 | 10 |

29.1.4 Youth Figures / 13-15 Figures

| Group & Figure # | Figure Name | DD |
|------------------|---------------------------------------|-----|
| Section A | | |
| Group 1 | | |
| 140g | Flamingo Bent Knee, Twist Spin | 2.9 |
| 437 | Cyclone, Open 180° | 2.6 |
| Group 2 | | |
| 308h | Barracuda Airborne Split Spin Up 180° | 2.9 |

| | | |
|------------------|--|-----|
| 407 | Swordfish Straight Leg Ariana Rotation | 2.6 |
| Section B | | |
| Group 3 | | |
| 356f | Whip Continuous Spin 720° | 3.0 |
| 441 | Saturn | 2.5 |
| Group 4 | | |
| 352 | Venus | 3.0 |
| 240i | Albatross Spin up 360° | 2.5 |
| Section C | | |
| Group 5 | | |
| 144 | Rio Straight Leg | 3.1 |
| 421 | Walkover Back Closing 360° | 2.4 |
| Group 6 | | |
| 440d | Ipanema Spinning 180° | 3.1 |
| 311j | Kip Combined Spin | 2.4 |

29.1.4.1 Section A

29.1.4.1.1 Group 1

- 140g Flamingo Bent Knee, Twist Spin DD 2.9

A Ballet Leg is assumed. The shin of the horizontal leg is drawn along the surface of the water to assume a **Surface Flamingo Position**. With the ballet leg maintaining its vertical position the hips are lifted as the trunk unrolls while the bent leg moves to a **Bent Knee Vertical Position**. The bent leg is extended to a **Vertical Position**. A *Twist Spin* is executed.

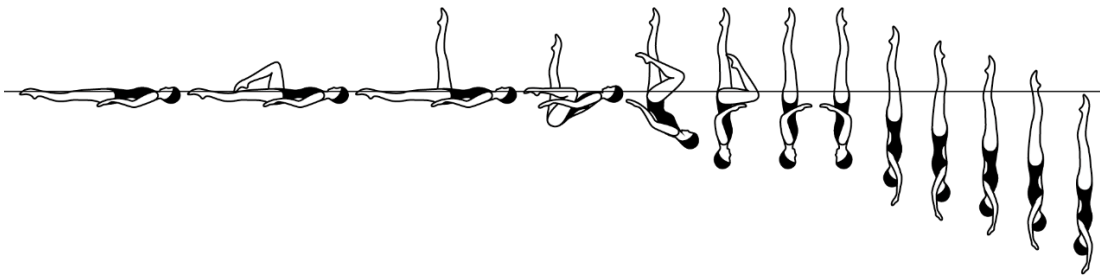

| | | | | | | | |
|------|------|------|------|------|------|------|--------------|
| | | | | | | | Total |
| NVT= | 10.5 | 11.0 | 7.5 | 20.0 | 16.5 | 48.0 | 113.5 |
| PV = | 0.93 | 0.97 | 0.66 | 1.76 | 1.45 | 4.23 | 10 |

2 - 437 Cyclone, Open 180° DD 2.6

From a **Back Layout Position** a *Bent Knee Surface Arch Position* is assumed. The legs are simultaneously lifted to a **Vertical Position** as a *Twirl* is executed. Continuing in the same direction the legs are opened symmetrically to a **Split Position** as a 180° rotation is executed. A *Walkout Front* is executed.

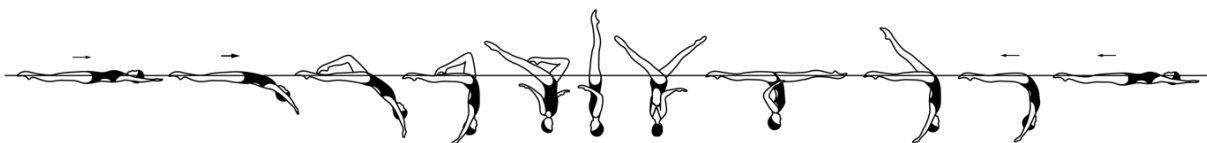

| | | | | | | |
|--|--|--|--|--|--|--------------|
| | | | | | | Total |
|--|--|--|--|--|--|--------------|





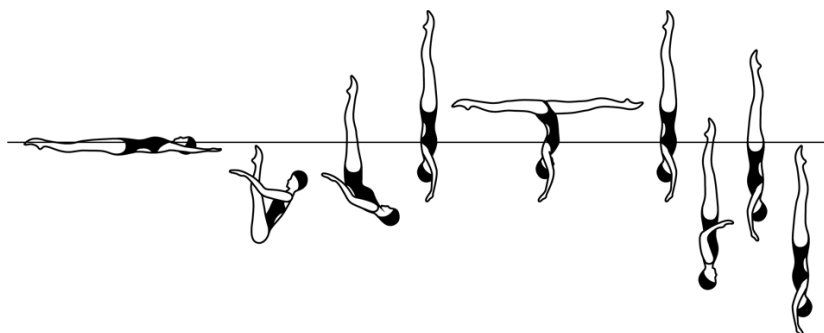

| | | | | | | |
|------|------|------|------|------|------|------|
| NVT= | 17.5 | 29.0 | 20.0 | 23.0 | 7.0 | 96.5 |
| PV = | 1.81 | 3.01 | 2.07 | 2.38 | 0.73 | 10 |

29.1.4.1.2 Group 2

1 - 308h Barracuda Airborne Split, Spin Up 180° DD 2.9

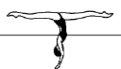
From a **Back Layout Position** the legs are raised to a vertical as the body is submerged to a **Back Pike Position** with the toes just under the surface of the water. All remaining movements are performed rapidly. A *Rocket Split* is executed. A *Vertical Descent* is executed and is completed as the ankles reach the surface of the water. A *Spin Up 180°* is executed. A *Vertical Descent* is executed.







| | | | | | | | | |
|---|---|---|---|---|---|---|---|--------------|
|  |  |  |  |  |  |  |  | Total |
| NVT= | 7.0 | 31.0 | 17.0 | 13.0 | 13.0 | 20.0 | 13.0 | 114 |
| PV = | 0.61 | 2.72 | 1.49 | 1.14 | 1.14 | 1.75 | 1.14 | 10 |

2 - 407 Swordfish Straight Leg Ariana Rotation DD 2.6

From a **Front Layout Position** the back arches as one leg is lifted in a 180° arc over the surface of the water to a **Split Position**. Maintaining the relative position of the legs to the surface of the water an *Ariana Rotation* is performed. A *Walkout Front* is executed.



| | | | | | |
|--|--|--|--|---|--------------|
|  |  |  |  |  | Total |
| NVT = | 48.0 | 17.0 | 23.0 | 7.0 | 95 |
| PV = | 5.05 | 1.79 | 2.42 | 0.74 | 10 |

29.1.4.2 Section B

29.1.4.2.1 Group 3

1 - 356f Whip Continuous Spin 720° DD 3.0

From a **Front Layout Position** a *Front Pike Position* is assumed. The legs are lifted to a **Vertical Position**. All remaining movements are performed rapidly. One leg is lowered to a **Fishtail Position** and without a pause is lifted to a **Vertical Position**. Without a pause a *Continuous Spin 720°* is executed.

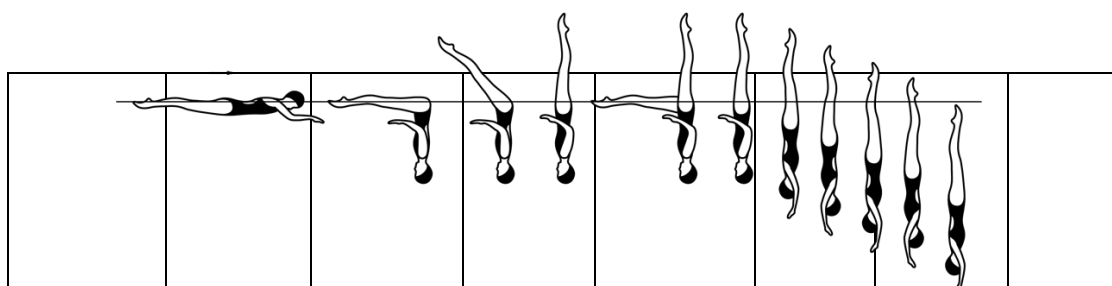

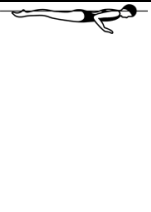
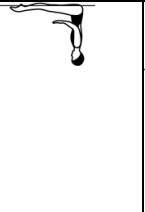
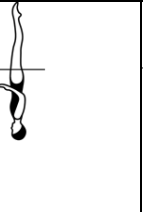
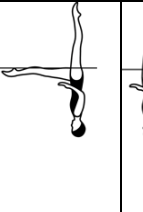
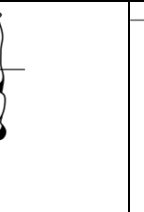
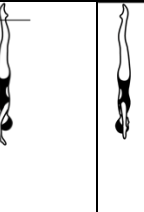
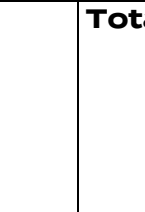
| | | | | | | | |
|---|---|---|---|---|--|---|--------------|
|  |  |  |  |  |  |  | Total |
| NVT= | 6.0 | 33.0 | 22.5 | 20.5 | 34.0 | 0 | 116 |
| PV = | 0.52 | 2.84 | 1.94 | 1.77 | 2.93 | 0 | 10 |

2 - 441 Saturn DD 2.5

From a **Back Layout Position** a *Surface Arch Position* is assumed. One leg is lifted to assume a **Knight Position**. Maintaining the vertical alignment the body rotates 180° to assume a **Fishtail Position**. Continuing in the same direction a *Twirl* is executed as the horizontal leg is lifted to a **Vertical Position**. A *Vertical Descent* is executed.

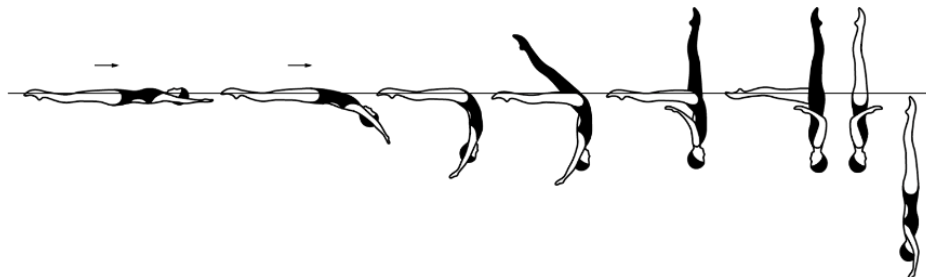

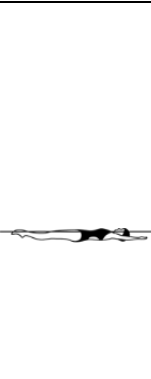
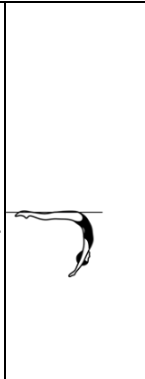
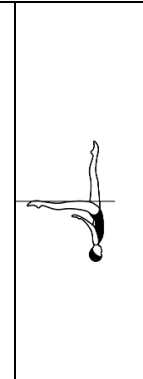
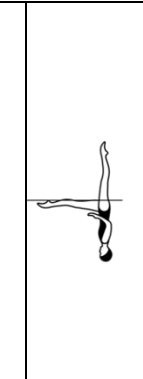
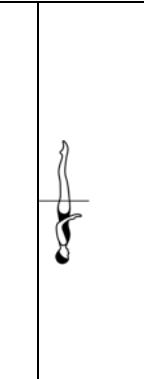
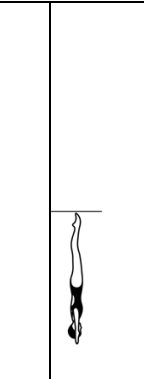





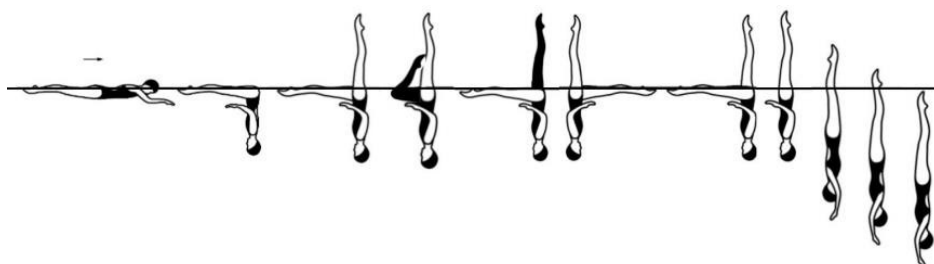

| | | | | | | |
|---|---|---|---|---|--|--------------|
|  |  |  |  |  |  | Total |
| NVT= | 12.0 | 23.5 | 14.0 | 23.5 | 14.0 | 87 |
| PV = | 1.38 | 2.70 | 1.61 | 2.70 | 1.61 | 10 |

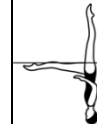
28.1.4.2.1 Group 4
1 - 352 Venus DD 3.0

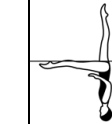
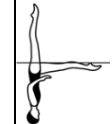
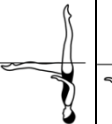
From a **Front Layout Position** a *Front Pike Position* is assumed. All remaining movements are performed rapidly. One leg is lifted to a **Fishtail Position**. The horizontal leg is bent to assume a **Bent Knee Vertical Position**. The bent leg is extended to vertical as the vertical leg is lowered to become the horizontal leg in **Fishtail Position**. A rotation of 360° is executed in the **Fishtail Position**. The horizontal leg is lifted to a **Vertical Position**. A 360° *Spin* is executed.









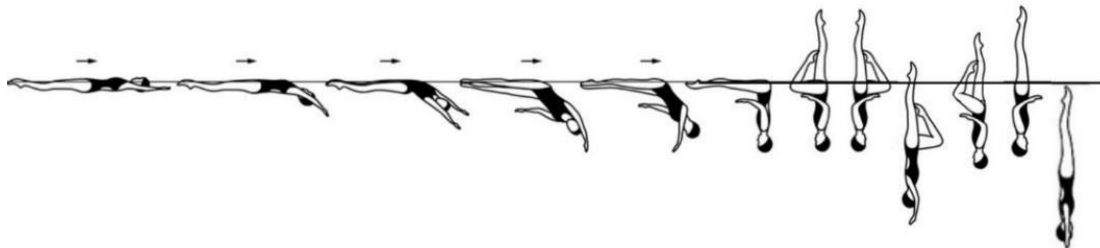

| | | | | | | | | | | |
|---|---|---|---|---|---|--|---|---|---|--------------|
|  |  |  |  |  |  |  |  |  |  | Total |
| NVT= | 6.0 | 12.5 | 12.5 | 18.5 | 24.0 | 20.5 | 23.0 | 0 | 117 | |
| PV = | 0.51 | 1.07 | 1.07 | 1.58 | 2.05 | 1.75 | 1.97 | 0 | 10 | |

- - 240i Albatross Spin Up 360° DD 2.5

From a **Back Layout Position** with the head leading, the head, hips and feet move along the surface of the water. The hips, legs and feet continue to move

along the surface of the water as the body rolls onto the face and a *Front Pike Position* is assumed with the hips occupying the position of the head at the beginning of this action. The legs are lifted simultaneously to a **Bent Knee Vertical Position**. A *Half Twist* is executed. Maintaining a **Bent Knee Vertical Position**, a *Vertical Descent* is executed until the ankle of the extended leg reaches the surface of the water. A *Spin Up 360°* is executed as the bent leg is extended to **Vertical Position**. A *Vertical Descent* is executed.









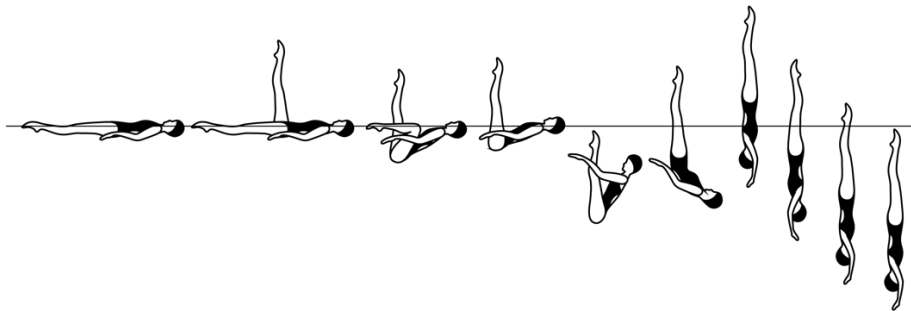

| | | | | | | | |
|---|---|---|---|---|---|---|--------------|
|  |  |  |  |  |  |  | Total |
| NVT= | 15.0 | 15.0 | 15.0 | 10.0 | 18.5 | 14.0 | 87.5 |
| PV = | 1.71 | 1.71 | 1.71 | 1.14 | 2.11 | 1.60 | 10 |

3.1.1.1
Section C
3.1.1.1.1 Group 5
1 - 144 Rio Straight Leg DD 3.1

A *Straight Ballet Leg* is assumed. The knee, shin and toes of the horizontal leg are drawn along the surface of the water to assume a **Surface Flamingo Position**. The bent leg is straightened to a **Surface Ballet Leg Double Position**. The body submerges vertically to a **Back Pike Position** with the toes just under the surface of the water. A *Thrust* is executed to a **Vertical Position**. A *Spinning 360°* is executed at the same tempo as the *Thrust*.







| | | | | | | | | |
|---|---|---|---|---|---|---|---|--------------|
|  |  |  |  |  |  |  |  | Total |
| NVT= | 18.5 | 7.5 | 13.0 | 12.0 | 31.0 | 39.0 | 0 | 121 |
| PV = | 1.53 | 0.62 | 1.07 | 0.99 | 2.56 | 3.22 | 0 | 10 |

2 - 421 Walkover Back Closing 360° DD 2.4

From a **Back Layout Position** a *Surface Arch Position* is assumed. One leg is lifted in a 180° arc over the surface of the water to a **Split Position**. With continuous motion a rotation of 360° is executed as the legs are symmetrically lifted and closed to a **Vertical Position**. A *Vertical Descent* is executed.









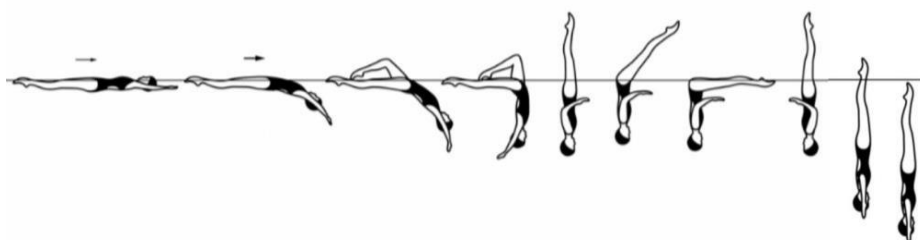

| | | | | | |
|---|---|---|---|--|--------------|
|  |  |  |  |  | Total |
| NVT= | 12.0 | 29.0 | 27.0 | 14.0 | 82 |
| PV = | 1.46 | 3.54 | 3.29 | 1.71 | 10 |

3.1.1.2 Group 6

1 - 440d Ipanema Spinning 180° DD 3.1

From a **Back Layout Position** a *Bent Knee Surface Arch Position* is assumed. The horizontal leg is lifted to vertical as the bent leg is straightened to assume a **Vertical Position**. The legs are lowered to a **Front Pike Position**. A rapid 180° rotation is executed as the legs are lifted to a **Vertical Position**. Continuing in the same direction a rapid *180° Spin* is executed.







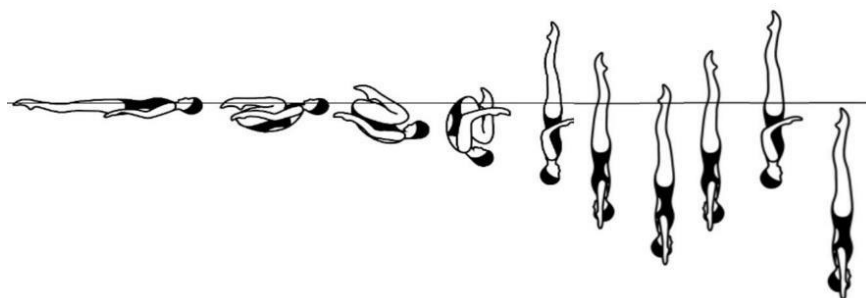

| | | | | | | | |
|---|---|---|---|---|---|---|--------------|
|  |  |  |  |  |  |  | Total |
| NVT= | 17.5 | 21.0 | 33.0 | 33.0 | 16.0 | 0 | 120.5 |
| PV = | 1.42 | 1.70 | 2.67 | 2.67 | 1.54 | 0 | 10 |

2- 311j Kip Combined Spin (360° + 360°) DD 2.4

From a **Back Layout Position** the knees, shins and toes are drawn along the surface of the water to assume a **Tuck Position**. With continuous motion the tuck becomes more compact and a partial Somersault Back Tuck is executed until the shins are perpendicular to the surface of the water. The trunk unrolls as the legs are straightened to assume a **Vertical Position** midway between the former vertical line through the hips and the former vertical line through the head and the shins. A rapid *Combined Spin* (360° + 360°) is executed followed by a rapid *Vertical Descent*.



| | | | | | | | |
|---|---|---|---|---|---|---|--------------|
|  |  |  |  |  |  |  | Total |
| NVT= | 3.0 | 2.0 | 23.0 | 40.0 | 14.0 | 82 | |
| PV = | 0.37 | 0.24 | 2.80 | 4.88 | 1.71 | 10 | |

3.2 Appendix 2 Technical Routines

3.2.1 General Requirements

In Olympic Games, Olympic Games Qualifier, Artistic Swimming World Cup, World Aquatics Artistic Swimming Championships and World Aquatics Junior Artistic Swimming Championships and other World Aquatics competitions as designated, Required Elements are used.

1. Unless otherwise specified in the description:

All required elements must be executed according to the requirements described in the World Aquatics AS Manual for Judges, Coaches and Referees.

2. If 1 or more competitors omits all or part of an element or performs an incorrect action in an element, refer to 2022-2025 World Aquatics Competition Regulations for penalties regarding incorrect or omitted actions.
3. Required Elements #1 - #5 can be performed in any order.
4. Required Elements #1 - #5 - It is required that the elements and the degrees of difficulty for each element selected to be performed, and the order of performance selected, must be declared and submitted on the Coach Card for the Technical Routine. This form must be submitted prior to the Competition/Event.
5. Additional hybrids and the degrees of difficulty for each hybrid selected, and the order to be performed, must be declared and submitted on the Coach Card for the Technical Routine. This form must be submitted prior to the Competition/Event.
6. With the exception of Deck Work, Entry, Hybrid Connected action (Mixed Duet), Acrobatic movement (Team), Pair Acrobatics (Duet and Mixed Duet), Cadence action (Team) and Circle Pattern (Team), Required and Free Elements and Transitions are to be performed simultaneously and facing same direction by all duet or team members.
7. Additional movements can be added immediately before and after (breath to breath) Required Elements #1 - #5. Those

movements will not add any extra difficulty nor will be considered as the additional hybrids.

8. Time limits – refer to VII.14

Recommendation for all Technical Routines:

It is strongly recommended for clarity of judgment that Required Elements #1 - #5 are separated by other content.

3.2.2 Solo Required Elements Element 1

1A - Thrust Continuous Spin 720° DD – 2.7

From a **Submerged Back Pike Position**, with the legs perpendicular to the surface, a *Thrust Continuous Spin 720°* (2 rotations) is executed.

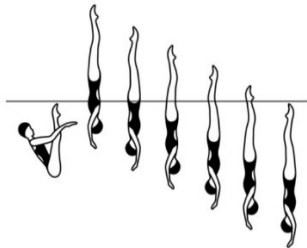

1B - Thrust Spinning 360° DD - 2.1

From a **Submerged Back Pike Position**, with the legs perpendicular to the surface, a *Thrust Spinning 360°* (1 rotation) is executed.

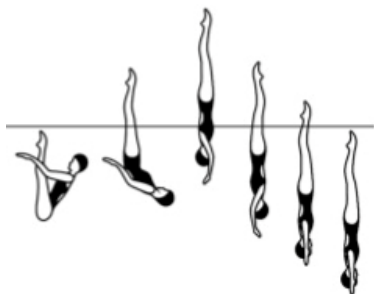

Element 2

2A – Combined Spin 1080° – Continuous Spin 1080° DD - 3.0

From a **Vertical Position** a *Combined Spin of 1080°* is executed (3 rotations +

3 rotations). Continuing in the same direction and without a pause a *Continuous Spin 1080°* (3 rotations) is executed.

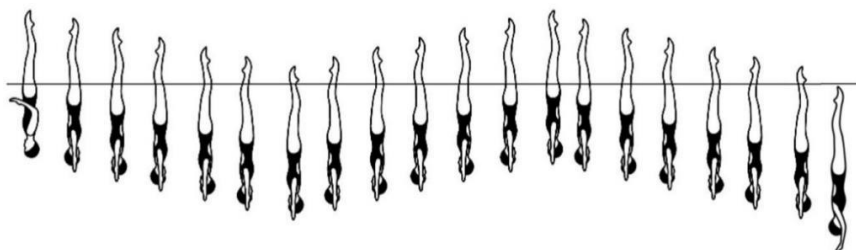

2B – Combined Spin 720° – Continuous Spin 1080° DD - 2.7

From a **Vertical Position** a *Combined Spin of 720°* is executed (2 rotations + 2 rotations). Continuing in the same direction and without a pause a *Continuous Spin 1080°* (3 rotations) is executed.

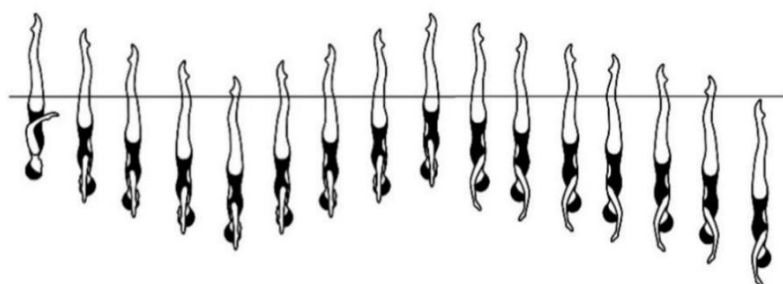

Element 3

3- Swordfish Straight Leg - Knight DD-3.2

From a **Front Layout Position**, the back arches as one leg is lifted in a 180° arc over the surface to a **Split Position**. A hip rotation of 180° is executed as the front leg is rapidly raised to assume a **Fishtail Position**. Maintaining the vertical alignment of the body and with accelerating speed, the foot of the horizontal leg is moved in a horizontal arc of 180° at the surface to a **Knight Position** and with continuous motion and continuing in the same direction an additional 180° rotation is executed. The vertical leg is lowered to a **Surface Arch Position** and with continuous motion an *Arch to Back Layout Finish Action* is executed.

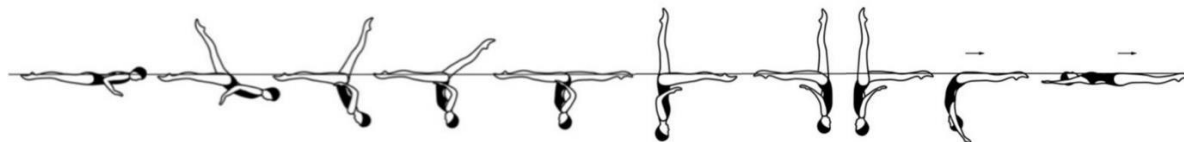

Element 4

4A – Fishtail Half Twist - Continuous Spin 720° DD – 2.9

From a **Front Pike Position**, a rotation of 360° is executed as one leg is lifted to a **Fishtail Position**. Continuing in the same direction a *Half Twist* in a **Fishtail Position** is executed. Continuing in the same direction another rotation of 360° is executed, as the horizontal leg is lifted to a **Vertical Position**. Continuing in the same direction, a *Continuous Spin of 720°* (2 rotations) is executed.

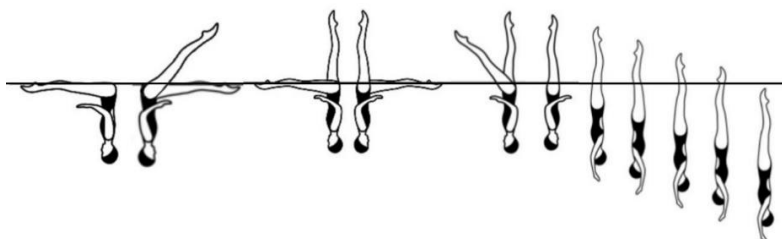

4B - Fishtail - Continuous Spin 720° DD – 2.6

From a **Front Pike Position**, a rotation of 360° is executed as one leg is lifted to a **Fishtail Position**. Continuing in the same direction another rotation of 360° is executed, as the horizontal leg is lifted to a **Vertical Position**. Continuing in the same direction a *Continuous Spin of 720°* (2 rotations) is executed.

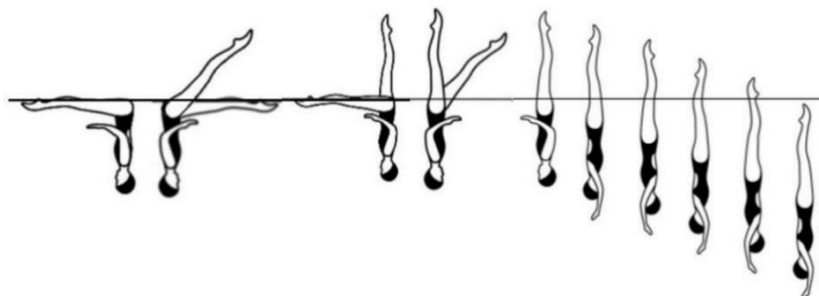

Element 5
5A – Rocket Split Bent Knee Joining 360° DD - 2.4

From a **Submerged Back Pike Position**, with the legs perpendicular to the surface, a *Thrust* is executed to a **Vertical Position**. Maintaining maximum height, the legs are split rapidly to assume an **Airborne Split Position**. The back leg is rapidly lifted to vertical and the front leg bends to assume a **Bent Knee Vertical Position**. A rapid *360° Spin* is executed as the bent knee is extended to a **Vertical Position** completed as the ankles reach the surface of the water followed by a *Vertical Descent* at the same tempo as the *Thrust*.

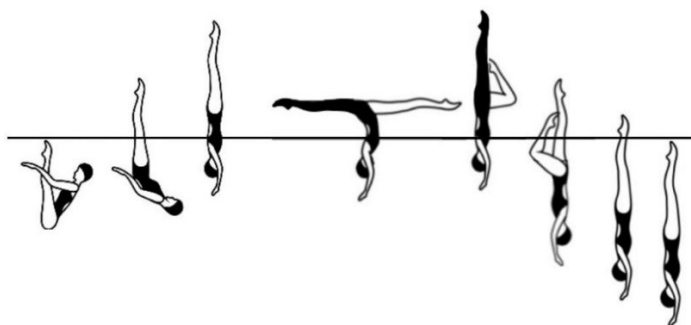
5B – Rocket Split Bent Knee DD - 2.1

From a **Submerged Back Pike Position**, with the legs perpendicular to the surface, a *Thrust* is executed to a **Vertical Position**. Maintaining maximum height, the legs are split rapidly to assume an **Airborne Split Position**. The back leg is rapidly lifted to vertical and the forward leg bends to assume a **Bent Knee Vertical Position**. A *Vertical Descent* is executed with the bent knee extended to a **Vertical Position** completed as the ankles reach the surface of the water, followed by a *Vertical Descent* at the same tempo as the *Thrust*.

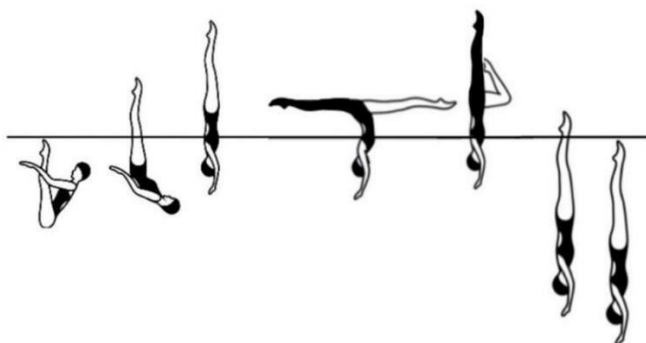

Solo Technical Routine Additional Requirements

1. Two (2) additional hybrids must be performed. These may be placed anywhere in the routine.

3.2.3 Duet Required Elements Element 1

1A – Walkover Back Closing 360° – Continuous Spin 1080° DD – 3.0

From a **Back Layout Position** a *Surface Arch Position* is assumed. One leg is lifted in a 180° arc over the surface to a **Split Position**. A rotation of 360° is executed, as the legs symmetrically close to a **Vertical Position**. Continuing in the same direction a *Continuous Spin of 1080°* (3 rotations) is executed.

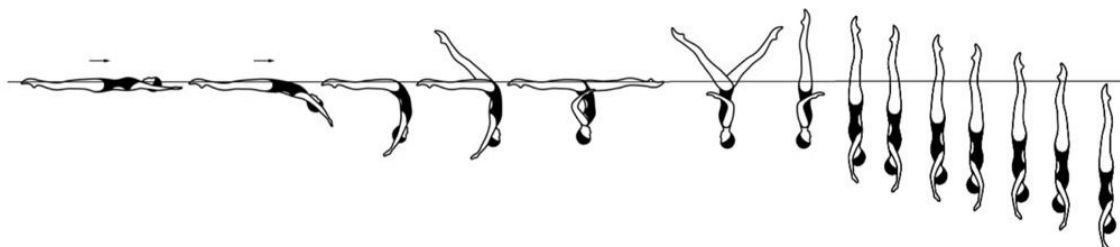

1B – Walkover Back Closing 180° – Continuous Spin 720° DD – 2.5

From a **Back Layout Position** a *Surface Arch Position* is assumed. One leg is lifted in a 180° arc over the surface to a **Split Position**. A rotation of 180° is executed, as the legs symmetrically close to a **Vertical Position**. Continuing in the same direction a *Continuous Spin of 720°* (2 rotations) is executed.

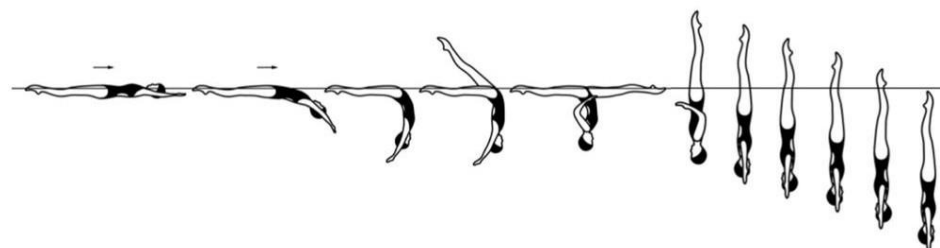

Element 2

2A – Rocket Split Alternating Legs – Spinning 180° DD – 2.8

From a **Submerged Back Pike Position**, with the legs perpendicular to the surface, a *Thrust* is executed to a **Vertical Position**. Maintaining maximum height, the legs are split rapidly to assume two alternating **Airborne Split Positions**. The legs rapidly re-join to a **Vertical Position**. A rapid *180° Spin* is

executed.

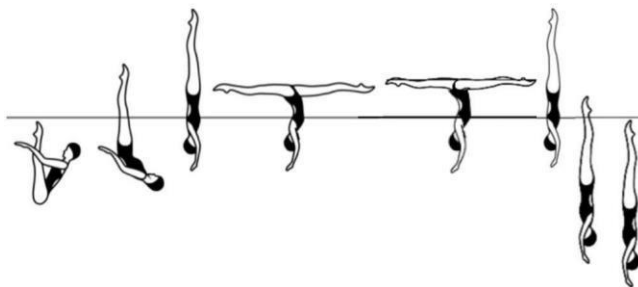

2B - Rocket Split – Spinning 180° DD - 2.4

From a **Submerged Back Pike Position**, with the legs perpendicular to the surface, a *Thrust* is executed to a **Vertical Position**. Maintaining maximum height, the legs are split rapidly to assume an **Airborne Split Position**. The legs rapidly re-join to **Vertical Position**. A rapid *180° Spin* is executed.

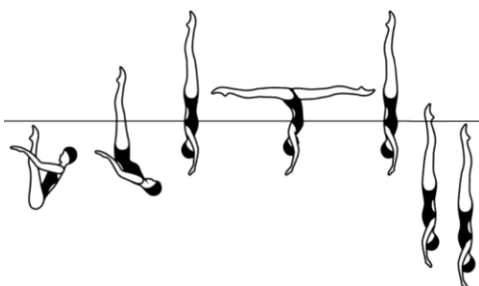

Element 3

3A- Flamingo Full Twist Hybrid DD – 2.9

From a **Surface Ballet Leg Double Position**, maintaining the vertical position of the legs, the hips are lifted as the trunk is unrolled to a **Vertical Position**. A *Full Twist* is executed. Continuing in the same direction and without a pause an additional rotation of 180° is executed as the legs are symmetrically opened to assume a **Split Position**. A *Walkout Front* is executed.

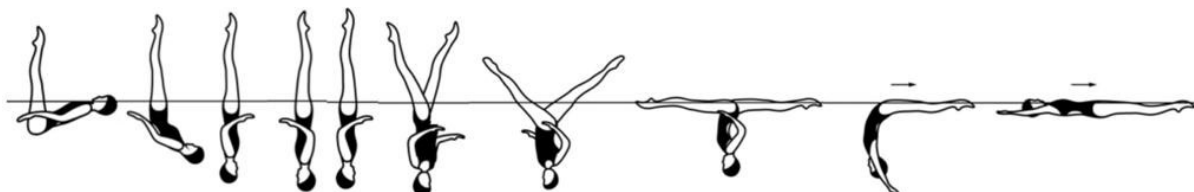

3B- Flamingo Half Twist Hybrid DD - 2.6

From a **Surface Ballet Leg Double Position**, maintaining the vertical position of the legs, the hips are lifted as the trunk is unrolled to a **Vertical Position**. A *Half Twist* is executed. Without a pause the legs open symmetrically to a **Split Position**. A *Walkout Front* is executed.

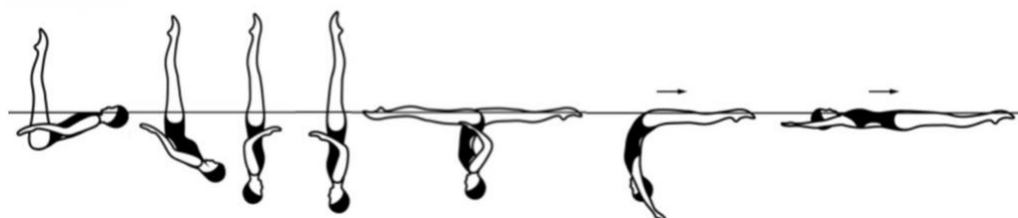

Element 4

4A - Fishtail – Knight - Continuous Spin 1080° DD - 3.2

A - From a **Front Pike Position** one leg is lifted to a **Fishtail Position**. The horizontal leg is rapidly lifted through an arc of 180° to assume a **Knight Position**. A rapid *Full Twist* is executed as the horizontal leg is lifted to a **Vertical Position**. Continuing in the same direction a *Continuous Spin 1080°* (3 rotations) is executed.

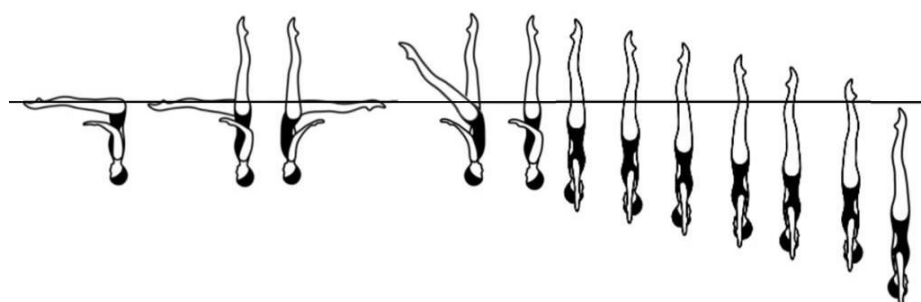

4B - Fishtail – Knight - Continuous Spin 720° DD – 2.7

From a **Front Pike Position** one leg is lifted to a **Fishtail Position**. The horizontal leg is rapidly lifted through an arc of 180° to assume a **Knight Position**. A rapid *Half Twist* is executed as the horizontal leg is lifted to a **Vertical Position**. Continuing in the same direction a *Continuous Spin 720°* (2 rotations) is executed.

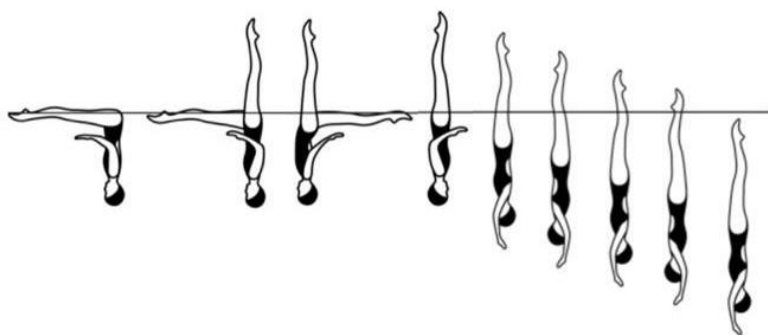

Element 5

5A – Thrust Bent Knee Twirl Spin 360° DD - 2.3

From a **Submerged Back Pike Position**, with the legs perpendicular to the surface, a *Thrust* is executed to a **Vertical Position**. One leg is lowered to a **Bent Knee Vertical Position** as a *Twirl* is executed. Continuing in the same direction and without a pause a rapid *360° Spin* is executed as the bent knee is extended to join the vertical leg in a **Vertical Position** completed as the ankles reach the surface of the water, followed by a *Vertical Descent* at the same tempo as the *Thrust*.

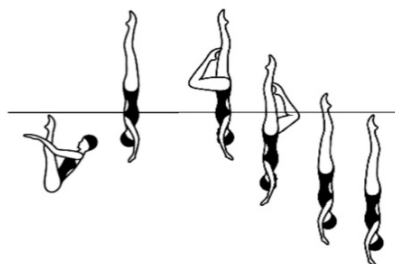

5B - Thrust - Bent Knee Twirl DD 2.1

From a **Submerged Back Pike Position**, with the legs perpendicular to the surface, a *Thrust* is executed to a **Vertical Position**. One leg is lowered to a **Bent Knee Vertical Position** as a *Twirl* is executed. Without a pause a *Vertical Descent* is executed as the bent knee is extended to join the vertical leg in a **Vertical Position** completed as the ankles reach the surface of the water, followed by a *Vertical Descent* at the same tempo as the *Thrust*.

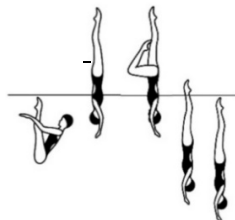

DUET Technical Routine Additional Requirements.

6. Two (2) additional hybrids and one (1) Pair Acrobatics must be performed. These may be placed anywhere in the routine.

3.2.4 Mixed Duet Required Elements Element 1

1A – Rocket Split Twirl Spin 180° DD – 2.7

From a **Submerged Back Pike Position**, with the legs perpendicular to the surface, a *Thrust* is executed to a **Vertical Position**. Maintaining maximum height, the legs are split rapidly to assume an **Airborne Split Position**. A *Twirl* is executed, as the legs symmetrically close to a **Vertical Position**.

Continuing in the same direction a rapid *180° Spin* is executed.

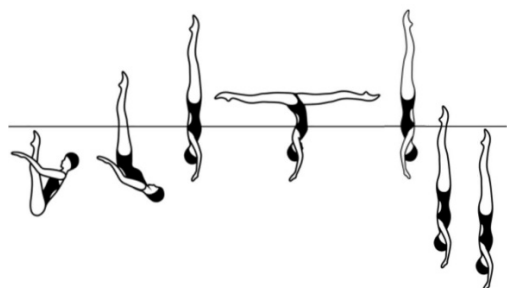

1B – Rocket Split Twirl DD – 2.5

From a **Submerged Back Pike Position**, with the legs perpendicular to the surface, a *Thrust* is executed to a **Vertical Position**. Maintaining maximum height, the legs are split rapidly to assume an **Airborne Split Position**. A *Twirl* is executed, as the legs symmetrically close to a **Vertical Position**. A *Vertical Descent* is executed at the same tempo as the *Thrust*.

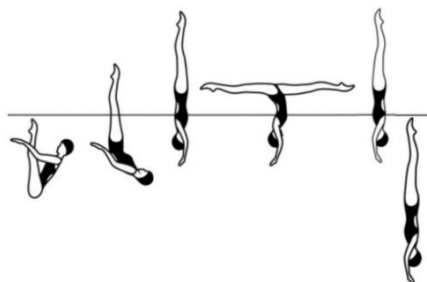

Element 2

2A - Front Pike – Vertical 360° Rotation - Full Twist to Bent Knee - Continuous Spin 720° DD 2.4 From a **Front Pike Position**, the legs are lifted to **Vertical Position** as a rotation of 360° is executed. Continuing in the same direction a *Full Twist* is executed as one leg is lowered to a **Bent Knee Vertical Position**. Continuing in the same direction a *Continuous Spin 720°* (2 rotations) is executed as the bent knee is extended to join the vertical leg to a **Vertical Position** completed as the ankles reach the surface of the water and continues through submergence.

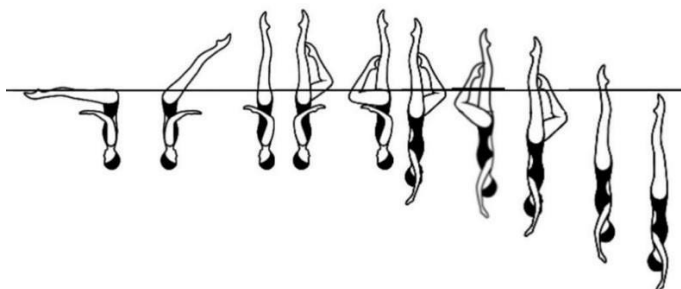

2B - Front Pike – Vertical 180° Rotation – 1/2 Twist to Bent Knee - Continuous Spin 720° DD 2.2

From a **Front Pike Position**, the legs are lifted to **Vertical Position** as a rotation of 180° is executed. Continuing in the same direction a *Half Twist* is executed as one leg is lowered to a **Bent Knee Vertical Position**. Continuing in the same direction a *Continuous Spin 720°* (2 rotations) is executed as the bent knee is extended to join the vertical leg to a **Vertical Position** completed as the ankles reach the surface of the water and continues through submergence.

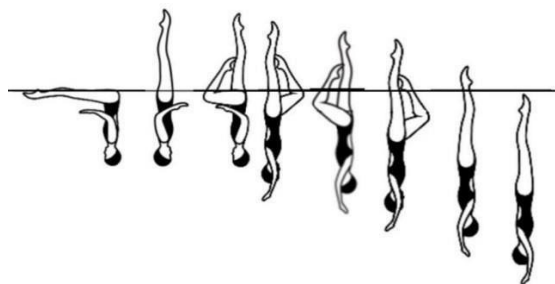

Element 3

3 – London Hybrid DD 3.3

A *Ballet Leg* is assumed followed by a partial Somersault Back Tuck as both legs are drawn into a **Tuck Position**, until the shins are perpendicular to the surface. The trunk unrolls rapidly as the legs are rapidly straightened to assume a **Vertical Position** midway between the former vertical line through the hips and the former vertical line through the head and the shins. The legs are symmetrically lowered to a **Split Position**, and without a pause a rapid hip rotation of 180° is executed as the front leg is raised to assume a **Fishtail Position**. The horizontal leg is rapidly lifted through an arc of 180° to assume a **Knight Position**. The vertical leg is lowered to assume a **Surface Arch Position**, and with continuous motion an *Arch to Back Layout Finish Action* is executed.

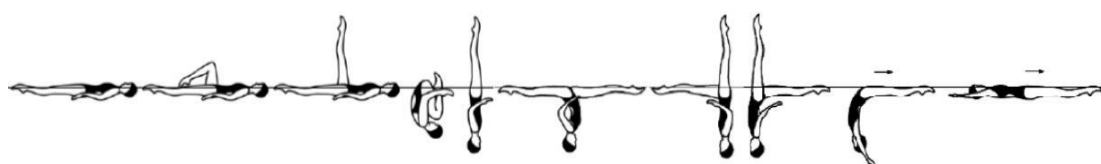

Element 4

4A - Nova Hybrid – Half Twist – Continuous Spin 1080° DD – 3.0

From a **Back Layout Position** a *Bent Knee Surface Arch Position* is assumed. The legs are lifted and join simultaneously to a **Vertical Position**, as a *Full Twist* is executed. Continuing in the same direction and without a pause a *Half Twist* is executed. Continuing in the same direction and without a pause a *Continuous Spin 1080°* (3 rotations) is executed.

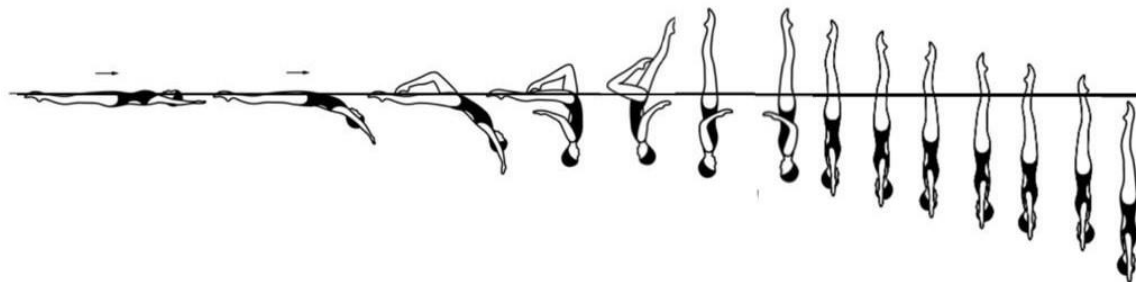

4B - Nova Hybrid –Continuous Spin 1080° DD – 2.6

From a **Back Layout Position** a *Bent Knee Surface Arch Position* is assumed. The legs are lifted and join simultaneously to a **Vertical Position**, as a *Full Twist* is executed. Continuing in the same direction and without a pause a *Continuous Spin 1080°* (3 rotations) is executed.



Fishtail Hybrid Airborne Position

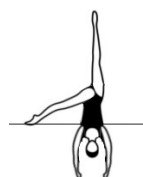

One leg is rapidly lowered to an airborne position midway between a **Side Fishtail Position** and a **Fishtail Position** with the foot of the lowered leg touching the surface of the water. Body is extended in a **Vertical Position** and hip joints must be on a horizontal line.

Element 5

5A -Thrust Fishtail Hybrid Bent Knee to Vertical Spinning 180° DD - 2.4

From a **Submerged Back Pike Position**, with the legs perpendicular to the

surface, a *Thrust* is executed to a **Vertical Position**. With no loss of height, one leg is rapidly lowered to an airborne position midway between a **Side Fishtail Position** and a **Fishtail Position** with the foot of the lowered leg touching the surface of the water. The horizontal leg is rapidly lifted as the vertical leg is rapidly lowered to assume a **Bent Knee Vertical Position**. A rapid *180° Spin* is executed, as the bent knee is extended to join the vertical leg in a **Vertical Position** completed as the ankles reach the surface of the water followed by a *Vertical Descent*.

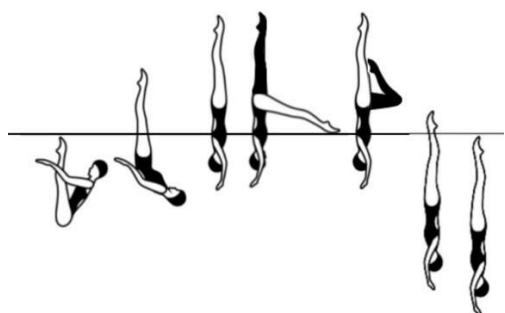

5B - Thrust Fishtail Helicopter Spinning 180° DD - 2.1

From a **Submerged Back Pike Position**, with the legs perpendicular to the surface, a *Thrust* is executed to a **Vertical Position** and with no loss of height one leg is rapidly lowered to an airborne **Fishtail Position**. A rapid *Helicopter Rotation Spinning 180°* is executed with the horizontal leg lifted to a **Vertical Position** during the rotation and is completed as the ankles reach the surface of the water followed by a *Vertical Descent*.

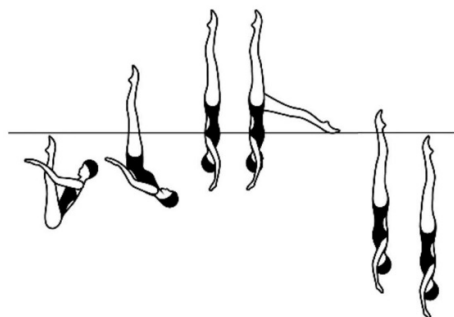

Mixed Duet - Technical Routine Additional Requirements

6. Two (2) additional hybrids, one of which must include a hybrid connection, and one (1) Pair Acrobatics must be performed. These may be placed anywhere in the routine

3.2.5 Mixed Duet Required Elements Element 1

1A – Flying Fish Hybrid Spinning 180° DD – 2.5

From a **Submerged Back Pike Position** with the legs perpendicular to the surface, a *Thrust* is executed to a **Vertical Position** and with no loss of height one leg is rapidly lowered to an airborne **Fishtail Position**. Without a pause the horizontal leg is rapidly lifted to a **Vertical Position**, followed by a rapid *180° Spin*.

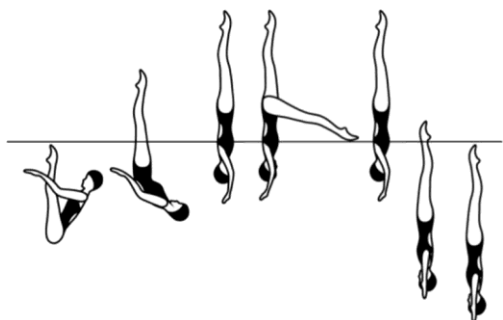

1B – Flying Fish Hybrid DD – 2.3

From a **Submerged Back Pike Position** with the legs perpendicular to the surface, a *Thrust* is executed to a **Vertical Position** and with no loss of height one leg is rapidly lowered to an airborne **Fishtail Position**. Without a pause the horizontal leg is rapidly lifted to a **Vertical Position** followed by a *Vertical Descent*.

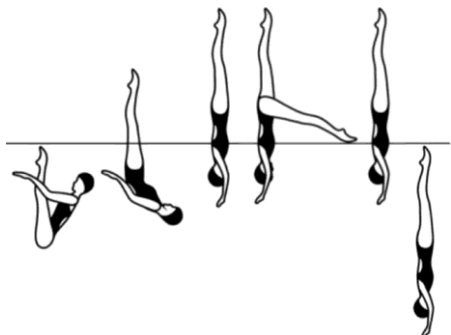

Element 2

2A - Vertical - Full Twist to Bent Knee - Full Twist to Vertical – Open 180° - Walkout DD - 2.6

Starting in a **Vertical Position**, a *Full Twist* is executed as one leg is lowered to a **Bent Knee Vertical Position**. Continuing in the same direction another *Full*

Twist is executed, as the bent knee is extended to a **Vertical Position**. Continuing in the same direction a *Half Twist* is executed as the legs are symmetrically lowered to a **Split Position**. A *Walkout Front* is executed.

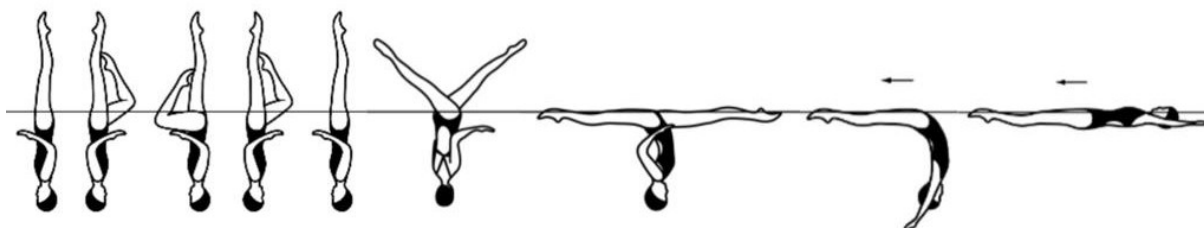

2B - Vertical - Half Twist to Bent Knee - Half Twist to Vertical – Split – Walkout DD - 2.3

Starting in a **Vertical Position**, a *Half Twist* is executed as one leg is lowered to a **Bent Knee Vertical Position**. Continuing in the same direction another *Half Twist* is executed, as the bent knee is extended to a **Vertical Position**. The legs are symmetrically lowered to a **Split Position**. A *Walkout Front* is executed.



***Fouetté Rotation* - New movement**

From a **Fishtail Position**, with the horizontal leg leading toward the vertical leg, a rapid 180° rotation is executed as the front leg bends to assume a **Bent Knee Vertical Position**. The bent leg rapidly extends to a **Fishtail Position**.

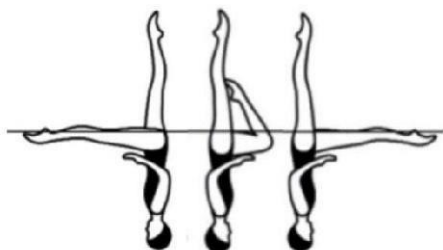

Element 3

3A – Two Fouetté Rotations – Vertical – Continuous Spin 720° DD – 2.6

From a **Fishtail Position**, 2 *Fouetté rotations* (180°+180°) are executed. The horizontal leg is rapidly lifted to a **Vertical Position**. Continuing in the same direction a *Continuous Spin of 720°* (2 rotations) is executed.

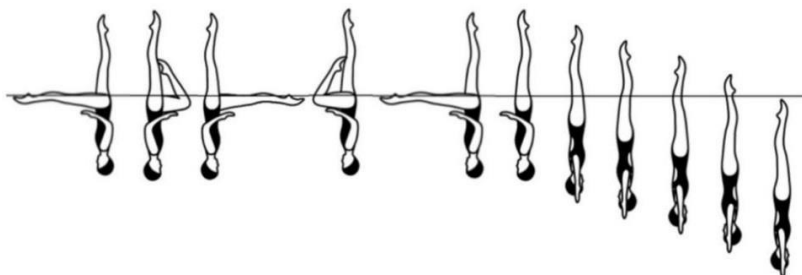

3B – Two Fouetté Rotations – Vertical – Spinning 360° DD – 2.3

From a **Fishtail Position**, 2 *Fouetté rotations* (180°+180°) are executed. The horizontal leg is rapidly lifted to a **Vertical Position**. Continuing in the same direction, a rapid *Spinning 360°* (1 rotation) is executed.

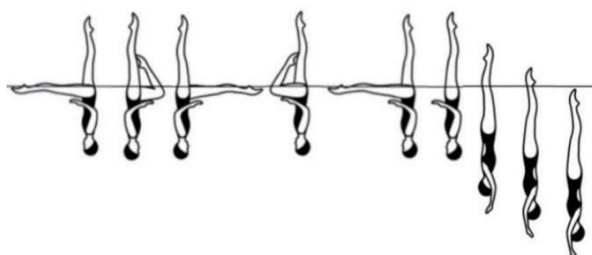

Element 4

4 - Butterfly Hybrid DD – 2.9

The Butterfly Hybrid is to be performed rapidly. From a **Front Pike Position**, one leg is lifted to a **Fishtail Position**. The horizontal leg is lifted through an

arc of 180° as the vertical leg is lowered to assume a **Split Position**. Without a pause a hip rotation of 180° is executed as the front leg is raised to assume a **Fishtail Position**. Continuing in the same direction a 180° rotation is executed as the horizontal leg is lifted to a **Vertical Position**. The legs are lowered simultaneously to a **Bent Knee Surface Arch Position**. (**Note: The Bent Knee Surface Arch Position** can be assumed by using either leg). The bent knee is straightened to a **Surface Arch Position** and with continuous motion an *Arch to Back Layout Finish Action* is executed.

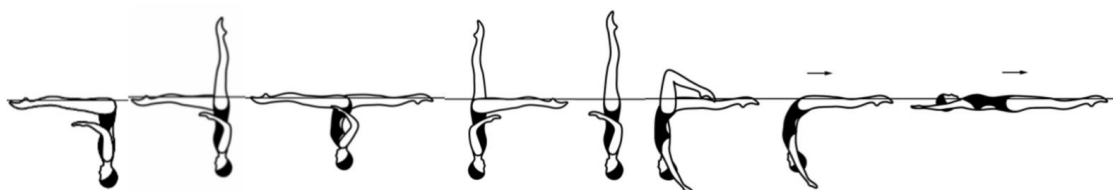

Element 5

5A-Rocket Split Bent Knee Twirl Hybrid DD – 2.4

From a **Submerged Back Pike Position** with the legs perpendicular to the

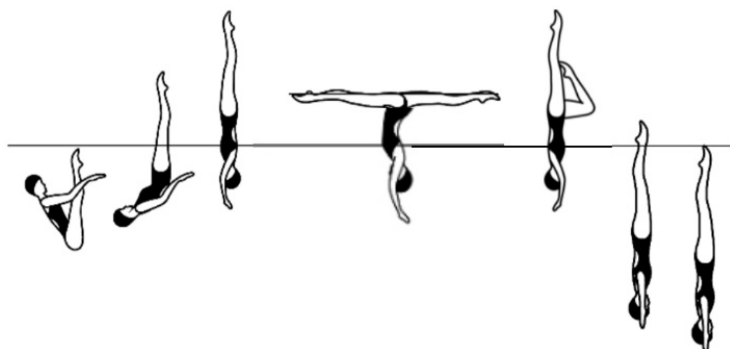

surface, a *Thrust* is executed to a **Vertical Position**. Maintaining maximum height, the legs are split rapidly to assume an **Airborne Split Position**, followed by a rapid rotation of 180° to assume an airborne **Bent Knee Vertical Position** with the front leg bent. A rapid *Vertical Descent* is executed as the bent knee is extended to join the vertical leg completed as the ankles reach the surface of the water followed by a *Vertical Descent*.

5B-Rocket Split Bent Knee Hybrid DD – 2.1

From a **Submerged Back Pike Position** with the legs perpendicular to the surface, a *Thrust* is executed to a **Vertical Position**. Maintaining maximum height, the legs are split rapidly to assume an **Airborne Split Position**

followed by the front leg rapidly bending and the back leg rapidly lifting to a vertical to assume an airborne **Bent Knee Vertical Position**. A *Vertical Descent* is executed as the bent knee is extended to join the vertical leg completed as the ankles reach the surface of the water followed by a *Vertical Descent*.

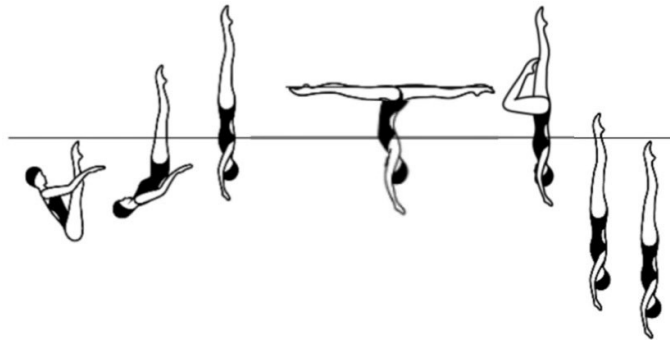

Team Technical Routine Additional Requirements

Three (3) additional hybrids, one of which must include a Cadence action, and one (1) acrobatic movement must be performed by all team members. These may be placed anywhere in the routine. The DD for the acrobatic movement must not **be less than 2.0 nor exceed 2.65** (in the Appendix VII)

Cadence Action: Identical movement(s) performed sequentially, one by one, by all team members. When more than one cadence action is performed, they must be consecutive and not separated by other optional or required elements. A second cadence action may begin before the first cadence action is completed by all team members but each team member must do the action of each cadence.

Acrobatic movements: A general term for jumps, throws, lifts, stacks, platforms, etc., which are performed as spectacular gymnastic feats and/or risky actions, and are mostly achieved with assistance from other swimmer(s). An acrobatic movement is considered when it starts and ends once all team members are **in** the water.

A routine may contain a maximum of one circle pattern.

The direction of propulsion may vary as long as all swimmers are facing the same direction.

Variations in propulsion and direction facing are permitted only during underwater pattern changes, underwater actions, and making and finishing a circle.

3.3 Appendix 3 - Set Numbers of Elements for Routines (Revised 25.10.2022)

| Senior/Junior | Time (+/- 5 sec) | Total Required Elements | Summary |
|---------------|---------------------|-------------------------------|---|
| Solo Tech | 2:00 | 7 | Total of 5 Technical Required Elements and 2 Free Hybrids |
| Solo Free | 2:15 | 7 | Total of 7 Free Hybrids |
| Duet Tech | 2:20 | 8 | Total of 5 Technical Required Elements, 2 Free Hybrids and 1 Pair Acrobatic |
| Duet Free | 2:45 | 9 | Total of 7 Free Hybrids, and 2 Pair Acrobatics |
| Mixed Tech | Duet 2:20 | 8 | Total of 5 Technical Required Elements, 2 Free Hybrids (one which must include a hybrid connection), and 1 Pair Acrobatic |
| Mixed Free | Duet 2:45 | 9 | Total of 6 Free Hybrids (one which must include a hybrid connection) and 3 Pair Acrobatics (one Lift, one Throw/Jump and one free choice) PLUS Additional Required movement for Free Mixed Duet: Two (2) connected surface movements with travel |
| Team Tech | 2:50 | 9 | Total of 5 Technical Required Elements and 3 Free Hybrids (one which must include Cadence action), and 1 Required Team Acrobatic* |
| Team Free | 3:30 | 11 | Total of 7 Free Hybrids and 4 Free Team Acrobatics* |

| | | | |
|----------------------|------|---|---|
| Acrobatic Routine | 3:00 | 7 | 7 Team Acrobatics* (1 of each group = 4 + 3 of free group choice) + transitions are free but no difficulty awarded + hybrids are free but no difficulty awarded |
|----------------------|------|---|---|

| Youth (13-15) | Time (+/- 5 sec) | Total Required Elements | Summary |
|----------------------|----------------------------|--|---|
| Solo Free | 2:00 | 6 | Total of 6 Free Hybrids |
| Duet Free | 2:30 | 7 | Total of 6 Free Hybrids and 1 Pair Acrobatic |
| Mixed Duet Free | 2:30 | 7 | Total of 5 Free Hybrids (one which must include a hybrid connection) and 2 Pair Acrobatics PLUS Additional Required movement for Free Mixed Duet: Two (2) connected surface movements with travel |
| Team Free | 3:00 | 9 | Total of 6 Free Hybrids and 3 Team Acrobatics* (with safety limit**) PLUS required components in any of the 6 Free Hybrids, both performed fully synchronised: One (1) Thrust (T1-T9) One (1) Spin descending 720o with one or two legs (R3) |
| Youth Combo | 3:00 | 9 | 4 Team Acrobatics* (with safety limit**) + Free Transitions + ONLY 1 x Solo Hybrid, 1 x Duet Hybrid, 3 x Team Hybrid (min of 4 athletes required) |

| 12U | Time (+/- 5 sec) | Total Required | Summary |
|------------|----------------------------|---------------------------|----------------|
|------------|----------------------------|---------------------------|----------------|

| | | Elements | |
|-----------------|------|-----------------|---|
| Solo Free | 2:00 | 5 | Total of 5 Free Hybrids |
| Duet Free | 2:30 | 6 | Total of 5 Free Hybrids and 1 Pair Acrobatic |
| Mixed Duet Free | 2:30 | 6 | Total of 5 Free Hybrids (one which must include a hybrid connection) and 1 Pair Acrobatic PLUS Additional Required movement for Free Mixed Duet: Two (2) connected surface movements with travel |
| Team Free | 3:00 | 9 | Total of 6 Free Hybrids and 3 Team Acrobatics* (with safety limit**) |
| 12U Combo | 3:00 | 8 | 3 Team Acrobatics* (with safety limit**) + Free Transitions + ONLY 1 x Solo Hybrid, 1 x Duet Hybrid, 3 x Team Hybrid (min of 4 athletes required) |

***Team Acrobatic definition as per the Acrobatic Catalogue (page 2):** “A team acrobatic movement is considered as an Element, starting from 4 swimmers and more (for example: 3 base swimmers + 1 featured swimmer; or 2 base swimmers + 1 support-swimmer who pushes 1 featured-swimmer) Must start and finish in the water! All other actions are considered as pair acrobatics or pair assist actions.”

****12U/Youth Acrobatic Safety Limit:** Acrobatic Elements cannot have a DD higher than the following: for Group A: 2.65, for Group B: 2.6, for Group C: 2.45, and for group P 2.5. Please refer to the World Aquatics Acrobatics Catalogue

3.4 Appendix 4 – Required Elements for Acrobatic Routine

3.4.1 General Requirements

1. Time Limits as in VII.14.1
2. Required Element #1 may be performed in any order

3. As in all routines, the Coach Card must show the Technical Required Elements in the selected order of performance according to Appendix VIII.28.3

3.4.2 Acrobatic Required Technical Elements

1. Seven (7) acrobatic movements: one from each acrobatic group (A, B, C, P), and three (3) more of free choice (selected from any group).

Acrobatic movement: is a general term for jumps, throws, lifts, stacks, platforms, etc., which is performed as spectacular gymnastic feats and/or risky actions and is mostly achieved with assistance by another swimmer(s).

3.5 Appendix 5 – Required Elements for the Free Combination

3.5.1 General Requirements

1. Time Limits: VIII.25.5
2. Start may be on the deck or in the water, or a combination of both.
3. All subsequent parts must start in the water
4. A new part begins in very close proximity to the previous part
5. As in all routines, the Coach Card must show the Technical Required Elements, and the Free Elements in the selected order of performance
6. The Routine must portray a Theme, which must be declared on the Coach Card.

3.5.2 Required Elements

1. At least two (2) parts must have fewer than three (3) competitors and at least two (2) parts must have all competitors.
2. The Free Combination must have four (4) acrobatic movements for Youth and three (3) acrobatic movements for 12 and under. Acrobatic Elements cannot have a DD higher than the following: for Group A: 2.65, for Group B: 2.6, for Group C: 2.45, and for group P 2.5. Please refer to the World Aquatics Acrobatics Catalogue.

DD values subject to adjustment by World Aquatics as required.

3.6 Difficulty Guide

The Difficulty Guide Can be found on the World Aquatics Website besides

PART EIGHT: MASTERS RULES

1. GENERAL

The Masters program shall promote fitness, friendship, understanding and competition through Swimming, Diving, Artistic Swimming, Water Polo and Open Water Swimming among competitors with a minimum age of 25 years. (Note: exception in VIII.6.1.3).

The Technical Rules for the different disciplines (SW, OW, DV, WP and AS) in the Competition Regulations shall be followed with exceptions mentioned in this Masters part of the Competition Regulations.

2. MASTERS GENERAL RULES

2.1 The Members shall register Masters Competitors in a special category for each of the five recognised disciplines. A competitor who registers for Masters in any discipline will still retain his/her unrestricted right to compete in other competitions.

2.2 Except for specific exceptions in the World Aquatics Rules and regulations all other World Aquatics Rules and Regulations shall apply to Masters Competitions.

2.3 Individual entries shall only be accepted from persons representing clubs. No swimmer or team may be designated as representing a country or Federation.

2.4 Age shall be determined as of December 31 of the year of competition.

2.5 Masters Competitors must be aware of the need of being well prepared and medically fit before entering into Masters Competitions. They shall assume full responsibility for the risks included in competing in such competitions. In consideration of their entry, they must agree to waive and release World Aquatics, the Organising National Federation and the Organising Committee from any kind of liability for accidents, which may cause death, injury or property loss. Entry Forms containing a warning of the risks, an Accident Waiver and Release of Liability must be signed by each Masters competitor.

3. MASTERS SWIMMING RULES

The Swimming Rules in Part II of these Competition Regulation apply to Masters with the following exceptions:

3.1 Age Groups

3.1.1 Individual Events:

25 – 29, 30 – 34, 35 – 39, 40 – 44, 45 – 49, 50 – 54, 55 – 59, 60 – 64, 65 – 69, 70 – 74, 75 – 79, 80 – 84, 85 – 89, 90 – 94 ... (five year age groups as high as is necessary).

3.1.2 Relays:

3.1.3 For all purposes pertaining to Masters meet competition, the actual attained age of the competitor shall be determined as of December 31st of the year of competition.

3.2 Events

The following events may be conducted for each age group.

3.2.1 Short course (25 m)

50, 100, 200, 400, 800, 1500m – **Freestyle**

50, 100, 200m – **Backstroke**

50, 100, 200m – **Breaststroke**

50, 100, 200m – **Butterfly**

100, 200, 400m – **Individual Medley**

4 x 50m – **Freestyle Relay**

4 x 50m – **Medley Relay**

4 x 50m – **Mixed Freestyle Relay (2 women and 2 men)**

4 x 50m – **Mixed Medley Relay (2 women and 2 men)**

4 x 100m – **Freestyle Relay**

4 x 100m – **Medley Relay**

4 x 100m – **Mixed Freestyle Relay (2 women and 2 men)**

4 x 100m – **Mixed Medley Relay (2 women and 2 men)**

4 x 200m – **Freestyle Relay**

4 x 200m – **Mixed Freestyle Relay (2 women and 2 men)**

3.2.2 Long course (50 m)

50, 100, 200, 400, 800, 1500m – **Freestyle**

50, 100, 200m – **Backstroke**

50, 100, 200m – **Breaststroke**

50, 100, 200m – **Butterfly**

200, 400m **Individual – Medley**

4 x 50m – **Freestyle Relay**

4 x 50m – **Medley Relay**

4 x 50m – **Mixed Freestyle Relay (2 women and 2 men)** 4 x 50m – **Mixed Medley Relay (2 women and 2 men)**

4 x 100m – **Freestyle Relay**

4 x 100m – **Medley Relay**

4 x 100m – **Mixed Freestyle Relay (2 women and 2 men)**

4 x 100m – **Mixed Medley Relay (2 women and 2 men)**

4 x 200m – **Freestyle Relay**

4 x 200m – **Mixed Freestyle Relay (2 women and 2 men)**

3.3 Masters Swimming Technical Rules

3.3.1 Age groups and sexes may be combined so that no swimmer has to swim alone and lanes may be filled.

3.3.2 When using the forward start, the referee's whistle shall indicate that the swimmers may take their positions with at least one foot at the front of the starting platform or pool deck, or in the water with one hand having contact with the starting wall.

3.3.3 All Masters events shall be conducted on a timed final basis.

3.3.4 Swimmers may be allowed to remain in their lane while other swimmers are competing until directed by the referee to exit the pool.

3.3.5 The Organising Committee may arrange 400 metre, 800

metre and 1500 metre Freestyle to be swum two (2) swimmers of the same sex in a lane. Separate timing will be required for each swimmer.

3.3.6 The Warm Up must be supervised.

3.3.7 A breaststroke kicking movement is permitted for butterfly. Only one breaststroke kick is permitted per arm pull except that a single breaststroke kick is permitted prior to the turn and the finish without an arm pull. After the start and after each turn, a single breaststroke kick is permitted prior to the first arm pull.

3.3.8 Swimmers who had to be disqualified must be listed with coded reason for disqualification in the results list.

3.4 Relays

3.4.1 Relays shall consist of four swimmers each registered with the same club. No swimmer is allowed to represent more than one club.

3.4.2 The order of swimmers by gender is optional in mixed relays.

3.5 Records

3.5.1 Masters World Records for all events listed in VIII.3.2 for both sexes in each age group shall be recognised and maintained in 1/100 second time (2 decimal places) and according to the provisions listed on the application form. World Records will be accepted only when times are recorded by Automatic Officiating Equipment, or Semi-Automatic Officiating Equipment in case of Automatic Officiating Equipment system malfunction.

3.5.2 Applications for Masters World Records must be made on the World Aquatics official forms by the individual in question within 60 days from the end of the event.

3.5.3 World Records can only be established in a Masters meet:

- a) formally sanctioned by a World Aquatics Member Federation; and
- b) organised for on behalf of a club or an organisation, which is a member of this World Aquatics Member Federation or recognised by World Aquatics; and

c) conducted under the rules of World Aquatics (and specially those relevant to Masters Swimming); and

d) in which only swimmers registered in a club member of a World Aquatics Member Federation participated.

3.5.4 The first swimmer in mixed relays may apply for a Masters World Record.

3.6 Masters Swimming World Records Application Instructions

3.6.1 General

World Records for Masters are recognized by World Aquatics in both Long Course (50 metre pools only) and Short Course (25 metre pool only). Performance must be registered at a Masters meet as per Rule VIII.3.5.3.

3.6.2 Events and Age Groups

3.6.2.1 Individual Events - for Men and Women

Freestyle – 50m, 100m, 200m, 400m, 800m and 1500m; Backstroke, Breaststroke and Butterfly – 50m, 100m and 200m; Individual Medley – 100m (Short Course only), 200m and 400m.

3.6.2.1.1 Age Groups

25 – 29, 30 – 34, 35 – 39, 40 – 44, 45 – 49, 50 – 54, 55 – 59, 60 – 64, 65 – 69, 70 – 74, 75 – 79, 80 – 84, 85 – 89, 90 – 94, 95 – 99, 100 – 104, ... (five year age groups as high as is necessary).

3.6.2.2 Relay Events - for Men, Women and Mixed (2 men and 2 women)

4x50m Freestyle, 4x50m Medley, 4x100m Freestyle, 4x100m Medley, 4x200m Freestyle

Relay Age Groups are calculated from the total age of team members (in whole years) 100 – 119 years, 120 to 159 years, 160 – 199 years, 200 to 239 years, 240 – 279 years, 280 to 319 years, 320 – 359 years, 360 to 399 years, ...(forty year increments as high as is necessary).

3.6.3 Eligibility

All applicants must be financial members of a Federation affiliated with

World Aquatics. Relay teams must be made up of four swimmers each properly registered with a single club. Swimmers may swim for only one club at any particular meet.

3.6.4 Timing

- Only electronic timing will be accepted. OR
- Semi-Automatic Timing in the case of where the Automatic Timing system malfunctioned
- Meet timing record or photocopy is to be attached to the application form.

3.6.5 Age Determining Date

For all purposes pertaining to Masters World Records and Masters World Championship meets, the actual attained age of the competitor as of 31 December of the year of the meet shall determine their age group for that competition and any record set during that competition.

3.6.6 Applications

Applications for records should be placed on World Aquatics Masters Swimming World Record Application Forms by the Meet Director and submitted within sixty (60) days of the event. The application is to be endorsed by either the Chief Timekeeper or the Referee of the meet. The National Federation is to verify the details of the applicant and ensure that all documentation is complete including:

- a. Certification of pool length;
- b. Proof of date of birth;
- c. Timing record.

The application should be forwarded to the World Aquatics Office located at:

Chemin de Bellevue 24a / 24b
1005 Lausanne Switzerland
Email: masters@worldaquatics.com

World Aquatics will decide whether to approve the record application. The World Aquatics Office will inform the National Federation of the results of each application. If after publication an error is detected, the swimmers have the right to appeal for a correction within 6 months of the publication date.

3.6.6.1 Detailed Instructions

Point 1 If the Record Application is for an Individual Event, then enter that Event Name from the above list item # 2.1. If it is for a Relay Event then enter that Event Name from the above list item # 2.2. Circle either Men, Women or Mixed.

Point 2 Enter the Official Time in minutes, seconds and 1/100th of second without rounding.

Point 3 If the Record Application is for an Individual Event then enter the Age Group from the above list item 2.1. If for a Relay Event then enter the Age Group from the above list item 2.2.

Point 4 Identify the Course Type as either Short Course 25 metres or Long Course 50 metres.

Point 5 Enter the Pool Name, City, Country and Date of the Official Sanctioned Masters Meet.

Point 6 A copy of the pool length confirmation must either be attached with this application or already on file with the World Aquatics Masters Recorder. A one-time measurement is required unless there are changes to the pool that might cause the pool measurements to change. Then the pool length must be confirmed again. Where a moveable bulkhead is used, it is not necessary for an additional course measurements confirmation of the lane where the time was achieved.

Point 7 If an Individual Event then list the swimmer's first name then last name, circle M for Men or W for Women, enter age (see item 5 above) and the full date of birth including the name of the month.

Point 8 If this record is for a Relay then list each member of the relay in the order they swam. List the swimmer's first name then last name, circle M for Men or W for Women, enter age (see item 5 above) and the full date of birth including the name of the month.

Point 9 A copy of each swimmer's birth certificate or passport must either be attached with this application or already on file with the World Aquatics Masters Recorder. A marriage certificate is not required.

Point 10 Enter the Club name of the individual swimmer or relay team and the Federation that this club is affiliated with.

Point 11 Enter the Official Time from the Primary Automatic Officiating Equipment. The time is entered in minutes, seconds and 1/100th second

without rounding.

Point 12 If the primary Automatic Officiating Equipment malfunctions then enter the times from the Backup Semi-Automatic Officiating equipment. The times are entered in minutes, seconds, 1/100th second without rounding.

Point 13 A printed copy from the Automatic Officiating Equipment is required. The printout must show the details including all backup times from the specific heat where the record occurred. Meet results with splits are not acceptable.

Point 14 Enter the Name and Title of the Certifying Official. A signature and date is required.

Point 15 The National Masters Recorder for the Federation where the swimmer(s) is affiliated must enter the Name and Federation. A signature and date is required.

3.7 Appendix - Ruling for Masters Top Ten tabulations.

Results that are valid for the World Aquatics Masters Top Ten results can only be established in a Masters meet:

- a)** formally sanctioned by a World Aquatics Member federation and,
- b)** organised for or on behalf of a club or an organisation, which is a member of this World Aquatics Member Federation or recognised by World Aquatics and
- c)** conducted under the rules of World Aquatics (and specially those relevant to Masters Swimming) and
- d)** in which only swimmers registered in a club member of a World Aquatics Member Federation participated.

4. MASTERS OPEN WATER SWIMMING RULES

Masters Open Water Swimming shall be defined as any event for which the distance is greater than 1500 metres and where entry is restricted to Master swimmers.

The Open Water Swimming Rules in Part IV of these Competitions Regulations shall apply to Masters Open Water Swimming with the following exceptions.

4.1 Masters Open Water Swimming events will be up to 5 km.

4.2 Age Groups for Open Water Swimming are the same as for Masters Swimming Individual Events (IX.3.1)

4.3 The water temperature shall be measured within 30 minutes before start of race and must be a minimum of 18°C and maximum of 31°C. The water temperature shall be certified by the Safety Officer as measured in as near to the middle of the course as possible at a depth of 40 cm.

4.4 It shall be compulsory for all swimmers to wear highly visible coloured swim caps.

4.5 At all Masters Open Water events the safety of the competition shall be of paramount importance.

5. MASTERS DIVING RULES

The Diving Rules in Part V of these Competitions Regulations shall apply to Masters Diving with the following exceptions.

5.1 Age Groups and Events

5.1.1 Springboard Diving – Men and Women (1 metre and 3 metre)

| Age Groupe (Years) | Total Number of | | Dives required |
|---------------------------|------------------------|--------------|-----------------------|
| | MEN | WOMEN | |
| 25 – 29 | 7 | 6 | |
| 30 – 34 | 7 | 6 | |
| 35 – 39 | 7 | 6 | |
| 40 – 44 | 7 | 6 | |
| 45 – 49 | 7 | 6 | |
| 50 – 54 | 6 | 5 | |
| 55 – 59 | 6 | 5 | |
| 60 – 64 | 6 | 5 | |
| 65 – 69 | 6 | 5 | |
| 70 – 74 | 5 | 4 | |
| 75 – 79 | 5 | 4 | |

| | | |
|------|---|---|
| 80 + | 4 | 3 |
|------|---|---|

(five year age groups as long as necessary)

5.1.2 Platform Diving - Men and Women (5 metre, 7.5 metre, or 10 metre)

| Age Groupe (Years) | Total Number of Dives required | |
|--------------------|--------------------------------|-------|
| | MEN | WOMEN |
| 25 – 29 | 6 | 6 |
| 30 – 34 | 6 | 6 |
| 35 – 39 | 6 | 6 |
| 40 – 44 | 6 | 6 |
| 45 – 49 | 6 | 6 |
| 50 – 54 | 5x | 5x |
| 55 – 59 | 5x | 5x |
| 60 – 64 | 5x | 5x |
| 65 – 69 | 5x | 5x |
| 70 – 74 | 4x | 4x |
| 75 – 79 | 4x | 4x |
| 80 + | 3x | 3x |

(five year age groups as long as necessary)

(x) 10m limited: Only feet first entries are allowed from the 10m platform and any performed dive from the 10m must not exceed degree of difficulty of 2.0.

5.1.3 Synchronised Diving

5.1.3.1 3m Springboard – Men and Women and Mixed Team

| Age Group | MEN | WOMEN | MIXED TEAM |
|-----------|-----|-------|------------|
| | | | |

| | | | |
|---------|---------|----------|---------|
| 50 – 99 | 2(*) +2 | 2(*) + 2 | 2(*) +2 |
| 100+ | 2(*) +2 | 2(*) +2 | 2(*) +2 |

(*) Degree of difficulty of 2.0 for each dive regardless of the formula for degree of difficulty of the dive.

5.1.3.2 Platform – Men and Women and Mixed Team

| Age Group | MEN | WOMEN | MIXED TEAM |
|------------------|------------|--------------|-------------------|
| 50 – 99 | 2(*) +2 | 2(*) + 2 | 2(*) +2 |
| 100+ | 2(*) +2 | 2(*) +2 | 2(*) +2 |

(*) Degree of difficulty of 2.0 for each dive regardless of the formula for degree of difficulty of the dive.

5.1.3.3 The Age Group in Synchronised Diving is decided by adding the ages of the two divers.

5.1.3.4 If in any of the two groups in Synchronised Diving the age of a diver is 50 years or more, the limitation from 10 m platform dives of only feet first and any dive from 10 m must not exceed degree of difficulty 2.0 applies for the pair.

5.2 Masters Diving Technical Rules

5.2.1 The diver can freely choose the dives from the dive table given in these Competitions Regulations. The only requirement is that in age groups 25 – 69 years, each dive performed has different dive number (as to Competition Regulations).

In age groups 70 and older dives with the same dive number can be repeated, if performed in a different position (straight, pike, tuck or free position).

5.2.2 Forward facing dives can be performed with or without running approach.

5.2.3 In synchronised diving events two divers from different clubs within the same Federation are permitted to compete as a

synchronised diving team in the 3m springboard and the platform synchronised diving competitions

5.2.4 In Synchronised Diving both divers must perform the same dive number and position. Otherwise, the Referees shall declare a failed dive (0 points).

6. MASTERS WATER POLO RULES

The Water Polo Rules in Part VIII of these Competitions Regulations shall apply to Masters Water Polo with the following exceptions:

6.1 Age Groups

6.1.1 Age groups for Masters Water Polo shall apply for men and women teams.

6.1.2 The age of the youngest member of the team determines the age group of the team. There are no restrictions on the ages of any players older than the youngest player on the team.

6.1.3 Age groups for teams are at five-year intervals beginning with 30. i.e. 30+, 35+, 40+, ...

6.2 Masters Water Polo Technical Rules

6.2.1 Each team shall consist of seven players, one of who shall be the goalkeeper and who shall wear the goalkeepers cap, and not more than eight reserves may be used as substitutes, listed on the game roster, which must be submitted to the official's table for each game, not less than 45 minutes before each game commences. All players listed on the game roster will be eligible to play in the game. After the games has commenced, a team playing with less than seven players shall not be required to have a goalkeeper.

6.2.2 It is not compulsory for a team to name a substitute goalkeeper. A goalkeeper who has been replaced by a substitute may, if the player returns to the game, play in any position.

6.2.3 The VI.APPENDIX B.4.3 shall apply except that the goalkeeper shall wear cap no. 1 and the other caps shall be numbered 2 to 15. A substitute goalkeeper shall wear a red cap numbered 13.

6.2.4 The uniform distance between the respective goal lines shall be

23.5 metres minimum, and the uniform width of the field of play shall be 17 metres minimum.

6.2.5 Rule VI.4.3.time standards shall apply except that the duration of the Masters games shall be four periods of seven minutes each actual play for the 30+, 35+, 40+ and 45+ age groups and six minutes each actual play for the 50+, 55+, 60+, etc. age groups.

6.2.6 Rule VI.7.3 method of scoring shall apply except that the time of possession of the ball shall be 35 seconds.

6.2.7 There shall be a two minute interval between each period of play. The teams including the players, coaches and team officials, shall change ends before starting the third period.

6.2.8 Women players may be members of men's teams.

7. MASTERS ARTISTIC SWIMMING RULES

The Artistic Swimming Rules in Part VII of these Competitions Regulations shall apply to all Masters Artistic Swimming except for the following:

7.1 Age Groups

7.1.1 Solo: 25 – 29, 30 – 39, 40 – 49, 50 – 59, 60 – 69, 70 – 79, 80 and over

7.1.2 Duet: 25 – 29, 30 – 39, 40 – 49, 50 – 59, 60 – 69, 70 – 79, 80 and over

with age determined by the average age of the competitors.

7.1.3 Mixed Duet: 25 – 29, 30 – 39, 40 – 49, 50 – 59, 60 – 69, 70 – 79, 80 and

over with age determined by the average age of the competitors.

7.1.4 Team: 25 – 34, 35 – 49, 50 – 64, 65 and over with age determined by the average age of the competitors.

7.1.5 Free Combination: 25 – 39, 40 – 64, 65 and over with age determined by the average age of the competitors.

7.1.6 The average age of the competitors in a routine shall be determined by adding the ages of the actual swimmers, dividing by the number of swimmers (not including the reserves) and dropping

any resulting fraction or decimal. (For example, if the average age of a Team is 49.833, they would swim in the 35–49 age group).

7.2 Events

7.2.1 The events of Masters Artistic Swimming are Solo, Duet, Mixed Duet, Team and Free Combination. Technical and Free Solos together constitute one event. Similarly, the Technical and Free Duets together is one event, the Technical and Free Mixed Duets together is one event and the Technical and Free Team is one event. The Combination by itself is one event.

7.2.2 The programme for a Masters Event shall be Technical Routines, Free Routines and Free Combination.

7.2.2.1 Technical Routine

The Technical Routines shall be performed for Solo, Duet, Mixed Duet and Team with the required elements selected by World Aquatics Masters Committee every four (4) year, subject to approval by the World Aquatics Bureau. Technical Routines have to include all required elements. Music selection is optional and may be the same as the music used in the Free Routine.

7.2.2.2 Free Routine

The Free Routine shall consist of Solo, Duet, Mixed Duet Team, and Free Combination. There are no restrictions as to choice of music, content or choreography.

7.3 Competitors

7.3.1 Competitors in Duet, Mixed Duet, Team and Free Combination shall represent the same club.

7.3.2 Teams shall consist of a minimum of four (4) members and a maximum of eight (8) members. Combination shall consist of a minimum of four (4) members and a maximum of ten (10) members.

7.4 Masters Artistic Swimming Technical Rules

7.4.1 Time Limits for Routines

Time limits for Technical Routines and Free Routines including ten (10) seconds for the deck movement.

7.4.1.1

Technical

| | |
|--------------------------|--------------------------------------|
| Routines Solo | 1 minute 30 seconds |
| Free Routines Solo | 2 minutes 30 seconds |
| 7.4.1.2 | Technical |
| Routines Duet | 1 minute 40 seconds |
| Free Routines Duet | 3 minutes |
| 7.4.1.3 | Technical |
| Routines Mixed Duet | 1 minute 40 seconds |
| Free Routines Mixed Duet | 3 minutes |
| 7.4.1.4 | Technical |
| Routines Teams | 1 minute 50 seconds |
| Free Routines Teams | 4 minutes |
| 7.4.1.5 | Free |
| Combination | 4 minutes |
| 7.4.1.6 | There shall be no minimum time limit |
| 7.4.1.7 | Maximum Time Limits: |

There shall be an allowance of fifteen (15) seconds plus the allotted time for Technical Routines, Free Routines and Combination.

7.4.2 The size of the competition pool shall be 25x20 metres and minimum 2.5 metres deep.

7.4.3 Goggles may be worn.

7.5 Appendix – Required Elements for Masters Technical Routines

7.5.1 General Requirements

Supplementary elements may be added.

7.5.1.1 Unless otherwise specified in the description of an element:

- All figures or components thereof shall be executed according to the requirements described in this Appendix.
- All elements shall be executed high and controlled in uniform motion with each section clearly defined.

7.5.1.2 Time limits as in VIII.7.4.1

7.5.1.3 Swimwear shall be black and the competitor shall wear a white cap.

7.5.2 Solo Required Elements

Elements 1 to 5 **MUST** be performed in the order listed. Element 6 may be performed at any time during the routine.

1. **FISHTAIL** – from a Front Layout Position, a Front Pike Position is assumed; one leg is lifted to a Fishtail Position, the second leg is lifted to a Vertical Position (ending is optional).
2. **SPLIT POSITION** – followed by a walkout front or walkout back.
3. **SPINNING 180°** – From a Bent Knee Position, a Spin 180° is executed as the legs are joined to a Vertical Position at the ankles followed by submergence.
4. **TRAVELLING BALLET LEG COMBINATION** – Beginning in a Back Layout Position to include any 2 of the following positions – Bent Knee Back Layout, right; Bent Knee Back Layout, left; Ballet Leg, left; Ballet Leg, right; Flamingo Position, left; Flamingo Position, right; Ballet Leg Double.
5. **BARRACUDA BENT KNEE** – From the Back Pike Position with the legs perpendicular and the toes just below the surface, a Thrust is executed as one leg is drawn along the inside of the other extended leg to assume a Bent Knee Vertical Position. A Vertical Descent is executed in a Bent Knee Vertical Position at the same tempo as the Thrust.
6. **TWO (2) FORMS OF PROPULSION** – Must include Egg Beater travelling sideways and/or forward (arms optional)

7.5.3 Duet Required Elements

Elements 1 – 5 **MUST** be performed in the order listed Elements 6 – 7 may be executed at any time during the routine **Routines for Duet 1 to 6 as above for Solo**

7. **JOINED ACTION** – Where the swimmers are connected (touching) in some manner to perform on of the following:

- A connected figure or a connected float or connected stroking
- Action must be performed simultaneously. Minor action is permitted.
- Stacks, lifts, platforms, throws are not permitted.

With the exception of the DECK WORK and ENTRY and as noted in the JOINED ACTION, all elements, required and supplementary, MUST be performed simultaneously and facing the same direction by both swimmers, Variation in propulsion and direction facing are permitted during pattern changes.

7.5.4 Team Required Elements

Elements 1 – 5 MUST be performed in the order listed Elements 6 – 9 may be executed at any time during the routine **Routines for Team 1 to 7 as above for Duet**

8. **CADENCE ACTION** – Identical movements performed sequentially, one by one, by all team members. When more than one cadence action is performed, they must be consecutive and not separated by other optional or required elements. A second cadence action may begin before the first cadence action is completed by all team members but each team member must do the action of each cadence.

9. **PATTERNS** – must show a circle and straight line. Elements may be performed when in the circle or the straight-line patterns.

With the exception of the DECK WORK, ENTRY, CADENCE and as noted in the JOINED ACTION, all elements, required and supplementary, MUST be performed simultaneously and facing the same direction by all swimmers. Swimmers need not face the same direction in the circle pattern. Variation in propulsion and direction facing are permitted during pattern changes. Mirror actions are not permitted except in the description of the elements.

8. WORLD AQUATICS MASTERS CHAMPIONSHIPS

8.1 General

8.1.1 Management Committee

For World Aquatics Masters Championships, the Management Committee shall consist of the Bureau Liaison, the Chairman, the Vice-Chairman and the Honorary Secretary of the Masters Committee and other members of the Bureau and Masters Committee present.

8.1.2 Entry fees

Entry Fees shall be decided upon by the country that is hosting the World Aquatics Masters Championships, but they shall be subject to approval by World Aquatics.

8.1.3 Awards and Medals

For World Aquatics Masters Championships, medals shall be awarded to competitors and teams placed first, second and third in each event and Age Group.

In Artistic Swimming the reserves will receive medals only if they actually swim in the technical and/or Free Routine.

With the recommendation by the World Aquatics Masters Committee, the Organising Committee may present awards of lesser value for places from four on.

Diplomas can be awarded to competitors and team members placed first to ten in each event and Age Group.

8.1.4 Eligibility

A participant can represent only one club in each discipline.

8.1.5 Entry

Electronic Entries shall be used for registration and payment of fees to the World Aquatics Masters Championships via the World Aquatics General Management System (GMS), when available.

a. Swimming

i. Qualifying standards for World Aquatics Masters Championships will be considered by World Aquatics and the Organising Committee if deemed necessary.

ii. At the World Aquatics Masters Championships it is not necessary to conduct all events mentioned in Rule VIII.2. However, each age division should include shorter Freestyle, Backstroke, Breaststroke and Butterfly events plus Individual Medley and Relays.

iii. A swimmer can compete only once per relay event.

iv. Events shall be pre-seeded with oldest age groups first, slowest heats swum first within each age group. Events 400 metres and over may be seeded from slowest to fastest regardless of age.

v. A swimmer may be entered for not more than five (5) individual events.

vi. A swimmer entered for one club has to represent this club in all Swimming events at the Championships.

vii. The composition of a relay team can be changed up to the deadline announced by the Organising Committee on the day prior to the relay event. The age of the substitute swimmer(s) cannot change the age group of the entered relay team. Substitute swimmer(s) must be registered for the Championships.

b. Open Water Swimming

i. A Masters Open Water Swimming event may be included in World Aquatics Masters Championships.

ii. The Organising Committee shall follow the World Aquatics Masters Open Water Safety Regulations.

iii. Swimmers shall be seeded according to age groups from the youngest to the oldest. Swimmers may be selected irrespective of gender. The slowest entered swimmers of each age group may comprise and be seeded in special heat(s).

By recommendation of the World Aquatics Masters Committee and/or nominated Safety Officer this order may be changed.

iv.If the number of entries is more than 1'000 the competition may be swum in two or more days.

v.Race organisers, in consultation with the referee and subject to advice from the World Aquatics Masters Committee, are to designate in advance the cut off time. For the World Aquatics Masters Championships a cut off time of 30 minutes per kilometre shall apply.

c.Diving

i.The programme at the World Aquatics Masters Championships shall be carried out according to the following schedule:

| Springboard | Event No. | Sex | Age Group |
|--------------------|------------------|------------|------------------|
| 1 | 3 metre | Men | 25-34 |
| 2 | 1 metre | Women | 25-34 |
| 3 | 3 metre | Men | 35-49 |
| 4 | 1 metre | Women | 35-49 |
| 5 | 3 metre | Men | 50-64 |
| 6 | 1 metre | Women | 50-64 |
| 7 | 3 metre | Men | 65-80+ |
| 8 | 1 metre | Women | 65-80+ |
| 9 | 3 metre | Women | 65-80+ |
| 10 | 1 metre | Men | 65-80+ |
| 11 | 3 metre | Women | 50-64 |
| 12 | 1 metre | Men | 50-64 |
| 13 | 3 metre | Women | 35-49 |

| | | | |
|----|---------|-------|-------|
| 14 | 1 metre | Men | 35-49 |
| 15 | 3 metre | Women | 25-34 |
| 16 | 1 metre | Men | 25-34 |

Platform 5, 7.5, 10 metre

| | | | |
|----|--|-------|--------|
| 17 | | Women | 65-80+ |
| 18 | | Men | 65-80+ |
| 19 | | Women | 50-64 |
| 20 | | Men | 50-64 |
| 21 | | Women | 35-49 |
| 22 | | Men | 35-49 |
| 23 | | Women | 25-35 |
| 24 | | Men | 25-35 |

Synchronised Diving

| | | | |
|----|----------|------------|----------------|
| 25 | 3 metre | Women | 50-99 and 100+ |
| 26 | 3 metre | Men | 50-99 and 100+ |
| 27 | 3 metre | Mixed Team | 50-99 and 100+ |
| 28 | Platform | Women | 50-99 and 100+ |
| 29 | Platform | Men | 50-99 and 100+ |
| 30 | Platform | Mixed Team | 50-99 and 100+ |

- ii. The meet director may choose to run the events concurrently depending on the number of entries.
- iii. Diving sheets shall be delivered to the diving secretary 24 hours prior to the event. Late sheets and changed to an existing sheet will be fined USD 10,- per sheet between 24 hours and 3 hours prior to the event. 3 hours is the deadline. No changes or dive sheets can be accepted after the deadline of 3 hours.
- iv. At the World Aquatics Masters Championships at least 5 judges and in Synchronised Diving at least 7 judges shall officiate.
- v. All divers shall perform a full series of dives in that age group and there shall be no preliminary of final contests.
- vi. A diver can compete in only one team per Synchronised Diving event.

d. Water Polo

i. Composition of Teams

1. A player may not represent more than one team at the World Aquatics Masters Championships.
2. The final composition of the team with numbering of the caps shall be announced latest at the Technical Meeting prior to the Championships. All players must be registered as a player according to the entry specifications. No additional members can be added.
3. A Water Polo team can consist of up to fifteen (15) players registered with the same club.

ii. Composition of groups for the preliminary round

1. Before the draw for the World Aquatics Masters Championships the following exceptions of composing the

groups for the preliminary rounds shall be approved.

2. With less than three teams entered in one Age Group this Age Group shall be combined with the next younger Age Group or alternatively combined to the next older Age Group. The concerned teams shall be consulted for approval and given the possibility to cancel their participation with return of paid fees.

3. An Age Group with three teams entered can be combined with the next younger or older Age Group if these groups do not have more than four teams entered and with the approval of all concerned teams. The playing schedule and the plan for rankings shall be decided by the World Aquatics Masters Commission.

4. For the Women tournament the composition of groups is depending on the number of entries in each Age Group. The World Aquatics Masters Commission can combine the groups including teams of more than two Age Groups. The approval by the entered teams shall be asked. A playing schedule and the plan for rankings for each Age Group shall be decided by the World Aquatics Masters Commission.

iii. **Schedule for Age Groups**

1. Schedule for three (3) teams

The three teams shall play a double round-robin. If there is a tie in points between first and second placed teams they shall play a decisive game on Day 7.

| Day 1 | Day 2 | Day 3 | Day 4 | Day 5 | Day 6 | Day 7 |
|--------------|--------------|--------------|--------------|--------------|--------------|--------------|
| 1. | 2. | 3. | 4. | 5. | 6. | 7. |
| A1 - A3 | A2 - A3 | A1 - A2 | A2 - A3 | A1 - A3 | A1 - A2 | Final |

2. Schedule for four (4) teams

The four teams shall play a single round-robin as a preliminary round from Day 1 to Day 3. Semi-finals are played on Day 4, between the 1st and 4th and the 2nd and 3rd placed teams from the preliminary round. Day 5 will be a rest day. Finals shall be played on Day 6.

| Day 1 | Day 2 | Day 3 | Day 4 | Day 5 | Day 6 | Rankings |
|---------------|---------------|---------------|---------------|------------|----------------|----------------|
| 1. A1 - A3 | 3. A1 - A4 | 5. A3 - A4 | 7. 1A - 4A | (rest day) | 9. L7 - L8 | 3rd/4th |
| 2. A2 - A4 | 4. A2 - A3 | 6. A1 - A2 | 8. 2A - 3A | | 10. W7 - W8 | 1st/2nd |

3. Schedule for five (5) teams

The five teams shall play a single round-robin as a preliminary round on Day 1 to Day 5. The 5th placed team from the preliminary round will be ranked fifth. Semi-finals are played on Day 6 between the 1st and 4th and the 2nd and 3rd placed teams from the preliminary round. Finals shall be played on Day 7.

| Day 1 | Day 2 | Day 3 | Day 4 | Day 5 | Day 6 | Day 7 | Rankings |
|-------|-------|-------|-------|-------|-------|-------|----------|
|-------|-------|-------|-------|-------|-------|-------|----------|

| | | | | | | | |
|------------------|------------------|------------------|------------------|------------------|-------------------|------------------|----------------|
| 1. A1 - A5 | 3. A4 - A5 | 5. A3 - A4 | 7. A2 - A3 | 9. A3 - A5 | 11. 1A - 4A | 13. L11 - L12 | 3rd/4th |
| 2. A2 - A4 | 4. A1 - A3 | 6. A2 - A5 | 8. A1 - A4 | 10. A1 - A2 | 12. 2A - 3A | 14. W11-W12 | 1st/2nd |

4. Schedule for six (6) teams

The six teams shall play a single round-robin as a preliminary round on Day 1 to Day 5. Semi-finals are played on Day 6 between the 1st and 4th and 2nd and 3rd placed teams. Teams placed 5th and 6th will play for rankings 5 and 6. Finals shall be played on Day 7.

| Day 1 | Day 2 | Day 3 | Day 4 | Day 5 | Day 6 | Day 7 | Rankings |
|-------------|-------------|-------------|--------------|--------------|--------------|--------------------|--------------------------------------|
| 1. A1-A6 | 4. A3-A6 | 7. A4-A5 | 10. A5-A6 | 13. A4-A6 | 16. 5A-6A | | 5th/6th |
| 2. A3-A4 | 5. A2-A4 | 8. A2-A6 | 11. A1-A4 | 14. A3-A5 | 17. 1A-4A | 19. L17-L18 | 3rd/4th |
| 3. A2-A5 | 6. A1-A5 | 9. A1-A3 | 12. A2-A3 | 15. A1-A2 | 18. 2A-3A | 20. W17- W18 | 1st/2nd |

5. Schedule for seven (7) teams

The seven teams shall play a single round-robin from Day 1 to Day 7. Final rankings shall be based on points earned during the round-robin.

| Day 1 | Day 2 | Day 3 | Day 4 | Day 5 | Day 6 | Day 7 |
|-------------|-------------|-------------|--------------|--------------|--------------|--------------|
| 1. A1-A5 | 4. A2-A3 | 7. A6-A7 | 10. A1-A3 | 13. A2-A7 | 16. A3-A5 | 19. A5-A6 |
| 2. A2-A4 | 5. A4-A7 | 8. A1-A4 | 11. A4-A6 | 14. A4-A5 | 17. A1-A7 | 20. A3-A4 |
| 3. A3-A7 | 6. A1-A6 | 9. A2-A5 | 12. A5-A7 | 15. A3-A6 | 18. A2-A6 | 21. A1-A2 |

6. Schedule for (8) teams

The eight teams shall play on Day 1 to Day 3 a preliminary round-robin in two

Groups, A and B, with four teams in each group. The Quarter finals shall be played on Day 4 as cross-over games. The semi- finals shall be played on Day 5 between the winners of each Quarter final and for lower rankings between the losers. On Day 6 the rankings for rankings 5 to 8 will be played. The finals shall be played on Day 7.

| Day 1 | Day 2 | Day 3 | Day 4 | Day 5 | Day 6 | Day 7 | Rankings |
|--------------|--------------|--------------|--------------|--------------|--------------|--------------|-----------------|
| 1. | 5. | 9. | 13. | 17. | 21. | | 7th/8th |

| | | | | | | |
|------------------|------------------|------------------|------------------|--------------------|----------------|----------------|
| A2 - A3 | B1-B3 | A3- A4 | 2A- 3B | L13-L16 | L17-L18 | |
| 2. A1-A4 | 6. B2 - B4 | 10. A2-A1 | 14. 2B- 3A | 18. L14-L15 | 22. W17-W18 | 5th/6th |
| 3. B2 - B3 | 7. A2 - A4 | 11. B3- B4 | 15. 1A-4B | 19. W13- W16 | 23. L19-L20 | 3rd/4th |
| 4. B1-B4 | 8. A1-A3 | 12. B2 -B1 | 16. 1B-4A | 20. W14- W15 | 24. W19-W20 | 1st/2nd |

7. Schedule for nine (9) teams

The nine teams shall play on Day 1 to Day 5 a preliminary round-robin in two Groups, A and B, with four teams in Group A and with five team in Group B. The semi- finals shall be played on Day 6 between the two best placed teams from each preliminary group and the teams placed 3rd and 4th. The fifth team in Group B will be ranked for the 9th place. The final rankings from 1st to 8th shall be played on Day 7.

| Day 1 | Day 2 | Day 3 | Day 4 | Day 5 | Day 6 | Day 7 | Rankings |
|-------------|-------------|--------------|--------------|--------------|--------------|----------------|--------------------------------------|
| 1. A1-A4 | 5. B4-B5 | 7. A1-A3 | 11. B2-B3 | 13. A3-A4 | 17. 3A-4B | 21. L17-L18 | 7th/8th |
| 2. A2-A3 | 6. B1-B3 | 8. A2-A4 | 12. B1-B4 | 14. A1-A2 | 18. 3B-4A | 22. W17-W18 | 5th/6th |
| 3. B1-B5 | | 9. B2-B5 | | 15. B3-B5 | 19. 1B-2A | 23. L19-L20 | 3rd/4th |
| 4. B2-B4 | | 10. B3-B4 | | 16. B1-B2 | 20. 1A-2B | 24. W19-W20 | 1st/2nd |

8. Schedule for ten (10) teams

The ten teams shall play on Day 1 to Day 5 a preliminary round-robin in two Groups, A and B, with five teams team in both groups. The semi- finals shall be played on Day 6 between the two best placed teams from each preliminary group and the teams placed 3rd and 4th. The teams placed 5th shall play for the final rankings 9th and 10th. The final rankings from 1st to 8th shall be played on Day 7.

| Day 1 | Day 2 | Day 3 | Day 4 | Day 5 | Day 6 | Day 7 | Rankings |
|-------|-------|-------|-------|-------|-------|-------|---------------------------------------|
| 1. | 5. | 9. | 13. | 17. | 21. | | 9th/10th |

| | | | | | | | |
|-----------------|-----------------|------------------|------------------|------------------|------------------|----------------|----------------|
| A1-A5 | B4- B5 | A3- A4 | A2- A3 | B1-B2 | 5A- 5B | | |
| 2. A2- A4 | 6. B1- B3 | 10. A2- A5 | 14. A1- A4 | 18. B3- B5 | 22. 4A- 3B | 26. L22-L23 | 7th/8th |
| 3. B1- B5 | 7. A4- A5 | 11. B3- B4 | 15. B2- B3 | 19. A3- A5 | 23. 3A- 4B | 27. W22-W23 | 5th/6th |
| 4. B2- B4 | 8. A1-A3 | 12. B2- B5 | 16. B1- B4 | 20. A1-A2 | 24. 2A-1B | 28. L24-L25 | 3rd/4th |
| | | | | | 25. | 29. | 1st/2nd |

| | |
|-----|------|
| 1A- | W24- |
| 2B | W25 |

9. Schedule for eleven (11) teams

The eleven teams shall play on Day 1 to Day 5 a preliminary round-robin in two Groups, A and B, with five teams in Group A and six teams in Group

B. The semi-finals shall be played on Day 6 between the two best placed teams from each preliminary group the teams placed 3rd and 4th. The teams placed 5th shall play for rankings 9th and 10th. The team placed 6th in Group B will be ranked 11th. The final ranking rankings from 1st to 8th shall be played on Day 7.

| Day 1 | Day 2 | Day 3 | Day 4 | Day 5 | Day 6 | Day 7 | Rankings |
|-----------------|-----------------|------------------|------------------|------------------|------------------|--------------------|---------------------------------------|
| 1. A3- A4 | 6. B3- B5 | 11. A4- A5 | 16. B5- B6 | 21. A2- A4 | 26. 5A-5B | | 9th/10th |
| 2. A2- A5 | 7. B4- B6 | 12. A1-A3 | 17. B1-B4 | 22. A1-A5 | 27. 3A- 4B | 31. L27-L28 | 7th/8th |
| 3. B1-B6 | 8. B1-B2 | 13. B2- B6 | 18. B2- B3 | 23. B3- B6 | 28. 3B- 4A | 32. W27- W28 | 5th/6th |
| 4. B3- B4 | 9. A3-A5 | 14. B4- B5 | 19. A1-A4 | 24. B2- B4 | 29. 1A-2B | 33. L29-L30 | 3rd/4th |
| 5. B2- B5 | 10. A1-A2 | 15. B1-B3 | 20. A2- A3 | 25. B1-B5 | 30. 1B-2A | 34. W29- W30 | 1st/2nd |

10. Schedule for twelve (12) teams

The twelve teams shall play on Day 1 to Day 5 a preliminary round-robin in two Groups, A and B, with six teams in each group. Semi-finals shall be played on Day 6 between the two best placed teams from each preliminary group and the teams placed 3rd and 4th and the teams placed 5th and 6th. Finals for rankings 1st to 12th shall be played on Day 7.

| Day 1 | Day 2 | Day 3 | Day 4 | Day 5 | Day 6 | Day 7 | Rankings |
|-------------|--------------|--------------|--------------|--------------|--------------|----------------|--|
| 1. A1-A6 | 7. B4-B6 | 13. A4-A5 | 19. B5-B6 | 25. A3-A6 | 31. 6A-5B | 37. L31-L32 | 11th/12th |
| 2. A3-A4 | 8. B3-B5 | 14. A2-A6 | 20. B1-B4 | 26. A2-A4 | 32. 5A-6B | 38. W31-W32 | 9th/10th |
| 3. A2-A5 | 9. B1-B2 | 15. A1-A3 | 21. B2-B3 | 27. A1-A5 | 33. 4A-3B | 39. L33-L34 | 7th/8th |
| 4. B1-B6 | 10. A4-A6 | 16. B4-B5 | 22. A5-A6 | 28. B3-B6 | 34. 3A-4B | 40. W33-W34 | 5th/6th |
| 5. B3-B4 | 11. A3-A5 | 17. B2-B6 | 23. A1-A4 | 29. B2-B4 | 35. 2A-1B | 41. L35-L36 | 3rd/4th |
| 6. B2-B5 | 12. A1-A2 | 18. B1-B3 | 24. A2-A3 | 30. B1-B5 | 36. 1A-2B | 42. W35-W36 | 1st/2nd |

11. Schedule for thirteen (13) teams

The thirteen teams shall play on Day 1 to Day 3 a preliminary round-robin in

four Groups, with three teams in Groups A, B and C and four teams in group D. On Day 4 the teams placed 2nd and 3rd in each preliminary group shall play a second preliminary round in a cross group format. The first placed teams will have a rest day. The fourth placed team in Group D will be ranked 13th. Semi-finals and matches for rankings 9th to 12th shall be played on Day 6. Finals for rankings 1st to 8th shall be played on Day 7.

| Day 1 | Day 2 | Day 3 | Day 4 | Day 5 | Day 6 | Day 7 | Rankings |
|-----------|-----------|-----------|-----------|-------------|-------------|-------------|------------------------------------|
| 1 | 6 | 11 | 16 | 20 | 26 | | 11 th /12 th |
| A1-A3 | B1-B2 | C2- C3 | 2A- 3B | L16- L18 | L20-L21 | | |
| 2 | 7 | 12 | 17 | 21 | 27 | | 9 th /10 th |
| B1- B3 | C1-C2 | D1- D4 | 3A- 2B | L17- L19 | W20-W2 | | |
| 3 | 8 | 13 | 18 | 22 | 28 | 32 | 7 th /8 th |
| C1-C3 | D3- D4 | D2- D3 | 2C- 3D | 1A- W18 | L22-L23 | L28-L29 | |
| 4 | 9 | 14 | 19 | 23 | 29 | 33 | 5 th /6 th |
| D1- D3 | D1- D2 | A2- A3 | 3C- 2D | 1B- W19 | L24-L25 | W28- W29 | |
| 5 | 10 | 15 | | 24 | 30 | 34 | 3 rd /4 th |
| D2- D4 | A1-A2 | B2- B3 | | 1C-W16 | W22- W23 | L30-L31 | |
| | | | | 25 | 31 | 35 | 1 st /2 nd |
| | | | | 1D-W17 | W24- W25 | W30- W31 | |

12. Schedule for fourteen (14) teams

The fourteen teams shall play Day 1 to Day 3 a preliminary round-robin in four groups with three teams in Group A and B and with four teams in Group C

and D. On Day 4 the teams placed 2nd and 3rd shall play a second preliminary round in a cross group format. The first placed teams will have a rest day. The fourth placed teams from Groups C and D will play a decisive match for places 13th and 14th. Semi-finals and matches for rankings 9th to 12th shall be played on Day 6. Finals for rankings 1st to 8th shall be played Day 7.

| Day 1 | Day 2 | Day 3 | Day 4 | Day 5 | Day 6 | Day 7 | Rankings |
|-------------|------------------|------------------|------------------|--------------------|--------------------|--------------------|--|
| 1. A1-3 | 7. B1-B2 | 13. C1-C4 | 19. 4C- 4D | | | | 13th/14th |
| 2. B1-B3 | 8. C4- C3 | 14. C2- C3 | 20. 2A-B | 24. L20- L22 | 30. L24- L25 | | 11th/12th |
| 3. C1-C3 | 9. C1-C2 | 15. D1-D4 | 21. 3A- 2B | 25. L21- L23 | 31. W24- W25 | | 9th/10th |
| 4. C2-C4 | 10. D4- D3 | 16. D2- D3 | 22. 2C- 3D | 26. 1A- W22 | 32. L26-L27 | 34. L32- L33 | 7th/8th |
| 5. D1-D3 | 11. D1-D2 | 17. A2- A3 | 23. 3C- 2D | 27. 1B- W23 | 33. L28- L29 | 35. W32- W33 | 5th/6th |
| 6. D2-D4 | 12. A1-A2 | 18. B2- B3 | | 28. 1C- W20 | 34. W28- W29 | 36. L34- L35 | 3rd/4th |
| | | | | 29. | 35. | 37. | 1st/2nd |

| | | |
|------------|-------------|-------------|
| 1D- W21 | W26- W27 | W34- W35 |
|------------|-------------|-------------|

13. Schedule for fifteen (15) teams

The fifteen teams shall play Day 1 to Day 3 a preliminary round-robin in four groups with three teams in Group A and four teams in Groups B, C and D. On Day 4 the teams placed 2nd and 3rd shall play a second preliminary round in a cross format. The first placed teams will have a rest day on Day 4. From Day 4 to Day 6 the three fourth placed teams shall play a round-robin for places 13th to 15th. Semi-finals shall be played on Day 6 and the Finals on Day 7.

| Day 1 | Day 2 | Day 3 | Day 4 | Day 5 | Day 6 | Day 7 | Rankings |
|-----------------|------------------|------------------|--------------|--------------------|--------------------|-------|--|
| 1. A1-A3 | 8. B4- B3 | 15. C1-C4 | 22. 4B-4D | 27. 4C-4D | 34. 4B-4C | | 13 th /14 th /15 th |
| 2. B1-B3 | 9. B1-B2 | 16. C2- C3 | 23. 2A-3B | 28. L23- L25 | 35. L28- L29 | | 11 th /12 th |
| 3. B2- B4 | 10. C4- C3 | 17. D1-D4 | 24. 3A-2B | 29. L24- L26 | 36. W28- W29 | | 9 th /10 th |
| 4. | 11. | 18. D2- | 25. | 30. 1A- | 37. | 41. | 7 th /8 th |

| | | | | | | | |
|-----------|-----------|-----------|-------|------------|-------------|-------------|---------|
| C1-C3 | C1-C2 | D3 | 2C-3D | W25 | L30-L31 | L37-L38 | |
| 5. | 12. | 19. | 26. | 31. | 38. | 42. | 5th/6th |
| C2- C4 | D4- D3 | A2- A3 | 3C-2D | 1B- W26 | L32- L33 | W37- W38 | |
| 6. | 13. | 20. | | 32. | 39. | 43. | 3rd/4th |
| D1-D3 | D1-D2 | B1-B4 | | 1C- W23 | W30- W31 | L39-L40 | |
| 7. | 14. | 21. | | 33. | 40. | 44. | 1st/2nd |
| D2- D4 | A1-A2 | B2- B3 | | 1D- W24 | W32- W33 | W39- W40 | |

14. Schedule for sixteen (16) teams

The sixteen teams shall play on Day 1 to Day 3 a preliminary round-robin in four groups, Group A, B, C and D, with four teams in each group. On Day 4 the teams placed 2nd to 4th shall play second preliminary round, where the second and third placed teams in each group in a cross group format. The fourth placed teams in each group form a new group of four teams and they shall play for places 13th to 16th. The first placed teams will have a rest day on Day 4. The Quarter Final Round shall be played on Day 6. The finals for places 1st to 8th shall be played in Day 7.

| Day 1 | Day 2 | Day 3 | Day 4 | Day 5 | Day 6 | Day 7 | Rankings |
|--------------|--------------|--------------|--------------|--------------|--------------|--------------|------------------------------------|
| 1. | 9. | 17. | 25. | 31. | | | 15 th /16 th |
| A1-A3 | B4-B3 | C1-C4 | 4A-4B | L25-L26 | | | |
| 2. | 10. | 18. | 26. | 32. | | | 13 th /14 th |

| | | | | | | | |
|-----------|-----------|-------|-------|-------------|-------------|-------------|------------------------------------|
| A2- A4 | B1-B2 | C2-C3 | 4C-4D | W25- W26 | | | |
| 3. | 11. | 19. | 27. | 33. | 39. | | 11 th /12 th |
| B1-B3 | C4-C3 | D1-D4 | 2A-3B | L27-L29 | L33- L34 | | |
| 4. | 12. | 20. | 28. | 34. | 40. | | 9 th /10 th |
| B2- B4 | C1-C2 | D2-D3 | 3A-2B | L28- L30 | W33- W34 | | |
| 5. | 13. | 21. | 29. | 35. | 41. | 45. | 7 th /8 th |
| C1- C3 | D4- D3 | A1-A4 | 2C-3D | 1A-W29 | L35- L36 | L41-L42 | |
| 6. | 14. | 22. | 30. | 36. | 42. | 46. | 5 th /6 th |
| C2- C4 | D1-D2 | A2-A3 | 3C-2D | 1B-W30 | L37-L38 | W41- W42 | |
| 7. | 15. | 23. | | 37. | 43. | 47. | 3 rd /4 th |
| D1- D3 | A4-A3 | B1-B4 | | 1C-W27 | W35- W36 | L43-L44 | |
| 8. | 16. | 24. | | 38. | 44. | 48. | 1 st /2 nd |
| D2- D4 | A1-A2 | B2-B3 | | 1D-W28 | W37- W38 | W43- W44 | |

15. Schedule for seventeen (17) teams

The seventeen teams shall play on Day 1 to Day 4 a preliminary round- robin in four Groups, A, B, C and D, with four teams in Group A, B and C, and five teams in Group D and with the teams from D having for one day two matches.

The Quarter Finals shall be played on Day 5 with the first and second placed teams and the third and fourth placed teams shall play each other in a cross group format. The fifth placed team in Group D will be ranked 17th. Semi-finals shall be played on Day 6 and the Finals on Day 7.

| Day 1 | Day 2 | Day 3 | Day 4 | Day 5 | Day 6 | Day 7 | Rankings |
|-------------|--------------|--------------|--------------|--------------|--------------------|--------------------|------------------------------------|
| 1.D3-D5 | 10. C1-C3 | 17. D1-D4 | 24. A2-A4 | 29. 4A-3D | 37. L29-L30 | 45. L37-L38 | 15 th /16 th |
| 2.D1-D2 | 11. D4-D5 | 18. D2-D3 | 25. B1-B3 | 30. 3A-4D | 38. L31-L32 | 46. W37- W38 | 13 th /14 th |
| 3.C1-C2 | 12. D1-D3 | 19. A1-A3 | 26. C3-C4 | 31. 4B-3C | 39. W29- W30 | 47. L39-L40 | 11 th /12 th |
| 4.B3- B4 | 13. A2-A3 | 20. B1-B4 | 27. D3-D4 | 32. 3B-4C | 40. W31-32 | 48. W39- W40 | 9 th /10 th |
| 5.B1-B2 | 14. A1-A4 | 21. B2-B3 | 28. D2-D5 | 33. 2A-1D | 41. L33-L34 | 49. L41-L42 | 7 th /8 th |
| 6.A1-A2 | 15. B2-B4 | 22. C1-C4 | | 34. 1A-2D | 42. L35-L36 | 50. W41-W42 | 5 th /6 th |

| | | | | | | | |
|-------------|--------------|--------------|--|--------------|--------------------|--------------------|---------|
| 7.A3-A4 | 16. C2-C4 | 23. C2-C3 | | 35. 2B-1C | 43. W33- W34 | 51. L43-L44 | 3rd/4th |
| 8.D1-D5 | | | | 36. 1B-2C | 44. W35- W36 | 52. W43- W44 | 1st/2nd |
| 9.D2- D4 | | | | | | | |

16. Schedule for eighteen (18) teams

The eighteen teams shall play on Day 1 to Day 4 a preliminary round- robin in four Groups, A, B, C and D, with four teams in Group A and B, and five teams in Group C and D and with teams from C and D having for one day two matches. The Quarter Finals shall be played on Day 5 with the first and second placed teams and the third and fourth placed teams shall play each other in a cross group format. The fifth placed teams shall play final match for places 17th and 18th. Semi-finals shall be played on Day 6 and the Finals on Day 7.

| Day 1 | Day 2 | Day 3 | Day 4 | Day 5 | Day 6 | Day 7 | Rankings |
|-------|-------|-------|-------|-------|-------------|-------------|---|
| 1. | 9. | 18. | 27. | 33. | 41. | | 17th/18th h |
| B3-B4 | C4-C5 | D1-D4 | C2-C5 | 4A-3D | 5C-5D | | |
| 2. | 10. | 19. | 28. | 34. | 42. | 50. | 15th/16th h |
| B1-B2 | C1-C3 | D2-D3 | A2-A4 | 3A-4D | L33- L34 | L42- L43 | |

| | | | | | | | |
|-----------------|--------------|--------------|--------------|--------------|--------------------|----------------|--|
| 3. C3- C5 | 11. D4-D5 | 20. A1-A3 | 29. B1-B3 | 35. 4B-3C | 43. L35- L36 | 51. W42-W43 | 13th/14th |
| 4. C1-C2 | 12. D1-D3 | 21. B1-B4 | 30. C3-C4 | 36. 3B-4C | 44. W33- W34 | 52. L44-L45 | 11th/12th |
| 5. D3- D5 | 13. A2-A3 | 22. B2-B3 | 31. D3-D4 | 37. 2A-1D | 45. W35- W36 | 53. W44-W45 | 9th/10th |
| 6. D1- D2 | 14. A1-A4 | 23. C1-C4 | 32. D2-D5 | 38. 1A-2D | 46. L37-L38 | 54. L46-L47 | 7th/8th |
| 7. A1-A2 | 15. B2-B4 | 24. C2-C3 | | 39. 2B-1C | 47. L39- L40 | 55. W46-W47 | 5th/6th |
| 8. A3- A4 | 16. C1-C5 | 25. D1-D5 | | 40. 1B-2C | 48. W37- W38 | 56. L48-L49 | 3rd/4th |
| | 17. C2-C4 | 26. D2-D4 | | | 49. W39- W40 | 57. W48-W49 | 1st/2nd |

17. Schedule for nineteen (19) teams

The nineteen teams shall play on Day 1 to Day 4 a preliminary round- robin in four Groups, A, B, C and D, with four teams in Group A and five teams in Groups B, C and D and with teams from B, C and D having for one day two

matches. The Quarter Finals shall be played on Day 5 with the 1st and 2nd placed teams and the 3rd and 4th placed teams shall play each other in a cross group format. The 5th placed teams shall play a round-robin for rankings 17th to 19th. Semi-finals shall be played on Day 6 and the Finals on Day 7.

| Day 1 | Day 2 | Day 3 | Day 4 | Day 5 | Day 6 | Day 7 | Rankings |
|-------------|------------------|------------------|------------------|------------------|--------------------|--------------------|---|
| 1. B3-B5 | 11. C4- C5 | 20. D1- D4 | 29. B2- B5 | 37. 5B- 5C | 46. 5B-5D | 55. 5C-5D | 17th/18th /19th |
| 2. B1-B2 | 12. C1-C3 | 21. D2- D3 | 30. C2- C5 | 38. 4A- 3D | 47. L38-L39 | 56. L47-L48 | 15th/16th |
| 3. C3-C5 | 13. D4- D5 | 22. A1-A3 | 31. D2- D5 | 39. 3A- 4D | 48. L40-L41 | 57. W47- W48 | 13th/14th |
| 4. C1-C2 | 14. D1-D3 | 23. B1-B4 | 32. A1-A4 | 40. 4B- 3C | 49. W38- W39 | 58. L49-L50 | 11th/12th |
| 5. D3-D5 | 15. A2- | 24. B2- | 33. A2- | 41. 3B- | 50. W40- | 59. W49- | 9th/10th h |

| | | | | | | | |
|-------|-----------|-----------|-----------|-------|-------------|---------|----------------|
| | A4 | B3 | A3 | 4C | W41 | W50 | |
| 6. | 16. | 25. | 34. | 42. | 51. | 60. | 7th/8th |
| D1-D2 | B4- B5 | C1-C4 | B3- B4 | 2A-1D | L42-L43 | L51-L52 | |
| 7. | 17. | 26. | 35. | 43. | 52. | 61. | 5th/6th |
| A3-A4 | B1-B3 | C2- C3 | C3- C4 | 1A-2D | L44-L45 | W51-W52 | |
| 8. | 18. | 27. | 36. | 44. | 53. | 62. | 3rd/4th |
| A1-A2 | C1-C5 | D1-D5 | D3- D4 | 2B-1C | W42- W43 | L53-L54 | |
| 9. | 19. | 28. | | 45. | 54. | 63. | 1st/2nd |
| B1-B5 | C2- C4 | D2- D4 | | 1B-2C | W44- W45 | W53-W54 | |
| 10. | | | | | | | |
| B2-B4 | | | | | | | |

18. Schedule for twenty (20) teams

The twenty teams shall play on Day 1 to Day 4 a preliminary round-robin in four Groups, A, B, C and D, with five teams in each group and with teams from each group having for one day two matches. The Quarter Finals shall be played on Day 5 with the 1st and 2nd placed teams and the 3rd and 4th placed teams from each group. The 5th placed teams shall play each other in a cross group format. Semi-finals shall be played on Day 6 and the finals on Day 7.

| Day 1 | Day 2 | Day 3 | Day 4 | Day 5 | Day 6 | Day 7 | Rankings |
|-----------|-----------|-----------|-----------|-----------|-------------|---------|--|
| 1. | 11. | 21. | 31. | 41. | 51. | | 19th/20th |
| A3- A4 | B3- B5 | C4-C5 | D1-D4 | 5A- 5D | L41-L42 | | |
| 2. | 12. | 22. | 32. | 42. | 52. | | 17th/18th |
| A2- A5 | B1-B2 | C1-C3 | D2- D3 | 5B- 5C | W41- W42 | | |
| 3. | 13. | 23. | 33. | 43. | 53. | 61. | 15th/16th |
| B3- B4 | C3- C5 | D4- D5 | A1-A4 | 4A- 3D | L43-L44 | L53-L54 | |
| 4. | 14. | 24. | 34. | 44. | 54. | 62. | 13th/14th |
| B2- B5 | C1-C2 | D1-D3 | A2- A3 | 3A- 4D | L45-L46 | W53-W54 | |
| 5. | 15. | 25. | 35. | 45. | 55. | 63. | 11th/12th |
| C3- C4 | D3- D5 | A4- A5 | B1-B4 | 4B- 3C | W43- W44 | L55-L56 | |
| 6. | 16. | 26. | 36. | 46. | 56. | 64. | 9th/10th |
| C2- C5 | D1-D2 | A1-A3 | B2- B3 | 3B- 4C | W45- W46 | W55-W56 | |
| 7. | 17. | 27. | 37. | 47. | 57. | 65. | 7th/8th |
| D3- D4 | A3- A5 | B4- B5 | C1-C4 | 2A-1D | L47-L48 | L57-L58 | |
| 8. | 18. | 28. | 38. | 48. | 58. | 66. | 5th/6th |
| D2- D5 | A1-A2 | B1-B3 | C2-C3 | 1A-2D | L49-L50 | W57-W58 | |

| | | | | | | | |
|-----------|-----------|-----------|-------|-------|-------------|---------|----------------|
| 9. | 19. | 29. | 39. | 49. | 59. | 67. | 3rd/4th |
| A1- A5 | B1-B5 | C1-C5 | D1-D5 | 2B-1C | W47- W48 | L59-L60 | |
| 10. | 20. | 30. | 40. | 50. | 60. | 68. | 1st/2nd |
| A2- A4 | B2- B4 | C2- C4 | D2-D4 | 1B-2C | W49- W50 | W59-W60 | |

iv. **Draw**

1. The draw for the World Aquatics Masters Championships shall be made at least one month prior to start of the Water Polo competition. The seeding for the draw for the preliminary rounds shall be based on the placing at the previous World Aquatics Masters Championships as follows:

With two groups in the age group:

First line, the best and second best placed of the entered teams from the previous Championships,

Second line, two of the next best placed of the entered teams from the previous Championships,

The rest of the entered teams shall be placed in groups by a random draw.

With four groups in the age group:

First line, four of the best placed of the entered teams from the previous Championships,

The rest of the entered teams shall be placed in groups by a random draw.

2. Teams from the same country should not be drawn in the same group, if possible

3. The World Aquatics Masters Commission can decide, if needed, on additional criteria as base for the draw.

v. **Classification**

1. The classification of teams in the preliminary

rounds will be made based on Rule 1.6.6.

e. Artistic Swimming

i. In World Aquatics Masters Championships a club may enter up to five (5) routines in solo, duo, mixed duo and team in each age group in each event, and one (1) Free Combination in each age group.

ii. A competitor can take part in only one Duet, Mixed Duet, Team and one Free Combination.

iii. A female competitor can take part in both Duet and Mixed Duet.

iv. Changes in names of competitors for a routine must be received by the Chief Recorder at least 14 days prior to the first event of the Artistic Swimming competition. The new competitor must have already registered for the competition with the organising committee.

v. The reserves listed in a routine must be of an age that any combination of the listed competitors would result in swimming in the same age group.

vi. Any changes in reserves must be handed to the Chief Recorder in writing at least two hours prior to the listed start time for the age group routine. Changes after this can only be made in the case of sudden illness of or an accident to a competitor and if the reserve is ready to compete without delaying the competition.

vii. A competitor may be listed as a reserve on more than one routine in an age group event. However, once a competitor swims in one routine, that competitor is ineligible to swim in another routine in the same age group event.

viii. Failure to notify the Chief Recorder of substitution and/or scratches shall result in disqualification of the routine.

ix. **Order of Appearance**

1. For the World Aquatics Masters Championships, a computer draw for the Technical Routines shall be done by the Chief Recorder at least 24 hours before the Technical Meeting.

The order of the draw shall be Team, Free Combination, Duet and Solo.

2. When a competitor(s) draws start number one (1) in a Technical Routine, they will be exempted from drawing start number one (1) in another Technical Routine in the same Age Group, if possible.

Swimming number one (1) in a Technical Routine does not make a routine exempt from swimming number one (1) in the Free Routine in the same event.

3. The order of appearance for the Free Routines in each age group shall be determined by the results of the Technical Routines for that age group event and shall be swum in groups of 6 competitors.

If the number of competitors is not divisible by 6, the smallest group shall start first.

If there are fewer than 12 entries in an age group event, the draw will be in two equal groups, the smallest group start first.

If there is a tie in the placement in an age group event which overlaps two groups, those competitors shall form a group of their own and swim between the original groups.

4. For each age group event, the lowest scoring competitors in the Technical Routine will swim in the first group and the highest scoring competitors will swim in the last group.

5. Within each age group in each event, the highest scoring competitor in the Technical Routine for that age group and event shall draw first, with the next competitors drawing in order of Technical Routine placement. In the case of ties, the order of draw shall be based on the Technical Routine start number, with the lowest start number drawing first.





x. **Judging and Scoring**

1. At the World Aquatics Masters Championships at least four (4) judges shall officiate in three panels.

xi. **For the World Aquatics Masters Championships the Degree of Difficulty for Required Elements** shall be:



ELEMENT #1- 1.6



FISHTAIL – from a Front Layout Position, a Front Pike Position is assumed; one leg is lifted to a Fishtail Position, the second leg is lifted to a Vertical Position (ending is optional).

| | | | | | |
|---|---|---|---|--|-------|
|  |  |  |  | | Total |
| NVT= | 6.0 | 14.5 | 20.5 | | 41 |
| PV = | 1.46 | 3.54 | 5.00 | | 1.61 |

ELEMENT #2 - 1.3

SPLIT POSITION – followed by a walkout front or walkout back. The final DD is based on the lowest of the two values.



| | | | | | |
|---|---|---|--|--|--------------|
|  |  |  | | | Total |
| NVT= | 23.0 | 8.0 | | | 31 |
| PV = | 7.42 | 2.58 | | | 1.42 |

| | | | | | |
|---|---|---|--|--|--------------|
|  |  |  | | | Total |
| NVT= | 19.0 | 6.0 | | | 25 |

| | | | | | |
|-------------|------|------|--|--|------|
| PV = | 7.60 | 2.40 | | | 1.31 |
|-------------|------|------|--|--|------|







ELEMENT #3 – 1.1

SPINNING 180° – From a Bent Knee Position, a Spin 180° is executed as the legs are joined to a Vertical Position at the ankles followed by submergence.

| | | | | | |
|--|--|--|--|--|--------------|
|  |  |  | | | Total |
| NVT= | 15.0 | 0.0 | | | 15 |
| PV = | 10.0 | 0.0 | | | 1.13 |

ELEMENT #4 – 1.3

TRAVELLING BALLET LEG COMBINATION – Beginning in a Back-Layout Position to include any 2 of the following positions – Bent Knee Back Layout, right; Bent Knee Back Layout, left; Ballet Leg, left; Ballet Leg, right; Flamingo Position, left; Flamingo Position, right; Ballet Leg Double. The DD is based on the lowest value of two positions combined.

| | | | | | | |
|---|---|---|---|---|---|--------------|
|  |  |  |  |  |  | Total |
| NVT= | 10.5 | 11.0 | (13.0 or 18.5) | 3.0 | 19.0 | 21.5 |
| PV= | 4.77 | 5.0 | | 1.36 | 8.64 | 1.25 |

ELEMENT #5 – 1.6

BARRACUDA BENT KNEE – From the Back-Pike Position with the legs perpendicular and the toes just below the surface, a Thrust is executed as one leg is drawn along the inside of the other extended leg to assume a Bent Knee Vertical Position. A Vertical Descent is executed in a Bent Knee Vertical Position at the same tempo as the Thrust.

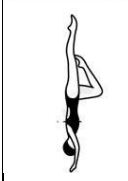
| | | | | | |
|---|--|------|--|--|--------------|
|  |  | | | | Total |
| NVT= | 28.0 | 11.0 | | | 39 |
| PV= | 7.18 | 2.82 | | | 1.57 |